



Dining & Service



Prep & Cook



Cook & Merchandise



Clean & Organize



Copyright © 2024 Winco® | Division of CFS Brands.
All rights reserved.

Product images and specifications subject to change without notice.

FRONT OF HOUSE



KITCHEN



EQUIPMENT



BACK OF HOUSE



www.wincous.com

winco®

ONE SOURCE

Foodservice Supplies

Welcome

A leading ONE-SOURCE supplier for tabletop, smallwares, and light equipment, serving the U.S.A. and International Markets.

Whether for foodservice in a hospital cafeteria, a restaurant, university, bakery, or coffee shop, Winco provides the tools to help make the experience efficient and inspired.

**The Right Product,
for the Right Price,
at the Right Time.**



3 DISTRIBUTION CENTERS

Best stock availability coast-to-coast



EXPANSIVE PORTFOLIO

22 categories covering Front of House, Kitchen, Back of House, & Equipment



PRODUCT BREADTH & DEPTH

6,000+ items all right here



BEST IN CLASS CUSTOMER SERVICE

Dedicated service team to assist with all your needs

winco
PUR-CLEAN™

COOL
HEAT™

winco
FIRE
IRON™

ACERO
by winco

Bar Maid
by winco

winco
KATTEX™

winco
SAFETY
CHECK™

TRI-GEN
by winco

winco
AFTER 5
BARWARE™

SOFTEK™
by winco

winco
PRIME

CURV
by winco

winco
SPECTRUM™

WinGo Bag™
by winco

winco
BENCH
MARK USA™

Front of House

Dining & Service

13

Dinnerware 14-33

Ardesia™ Porcelain	14-23
Ardesia™ Melamine	24-31
Ardesia™ Slate	31
Classic Winco Melamine	32-33

Flatware & Steak Knives 34

18/8 Flatware	Hollow Handle Knives
18/0 Flatware	Steak Knives

Chafers & Buffet Service 54

Chafers & Accessories	Juice Dispensers
Chafing Fuel	Serving Trays & Utensils
Coffee Urns	Signs-Clip, Chain, Tent
Electric Water Pan	VIRTUOSO™ Chafers

Tabletop 74

Condiment Dispensers and Sauce/Dessert Cups	Salt Shakers
Fajita Servers & Sizzle Platters	Seafood Trays
FireIron™ Mini Cast Iron	Serving Baskets-
Glass Shakers & Caddies	Plastic, Woven Poly, Wire
Maestro™ Pepper Mills	Serving Boards & Trays
Mini Baskets & Cups	Snail Server
Mini Cans & Pails	Sugar & Creamers
Mini Cookware/Serveware	Taco & Salsa/Dip Service
Salad Bowls	Tortilla Presses

Dining Service 91

Cafeteria/Mess Trays	Order Racks & Check Service
Call Bells & Crumbers	Seafood/Snail Service
Cheese Knives	Serving Trays & Stands
Coat Check	Signs-
Condiment Dispenser	Stanchion Floor Stands, LED, Information, Braille
Cotton Gloves	Squeeze Bottles
Decorative Picks	STABLEizer™ Wedges/Shims
Display Boards & Easels	Straw & Napkin Dispensers
Electric Tealights	Table Covers
Flatware Organizers	Table Signs & Clips
Graters, Zesters & Peelers	Wine Service
Menu Covers & Stands	

Beverage Service 120

Airpots & Racks	Juice Dispensers
Beverage Dispensers	Pitchers-
Coffee & Tea Accessories	Plastic, Stainless Steel
CADENZA™ Monte Carlo™	Plastic Drinkware
Coffee/Tea Service	Punch Bowl
Cup & Lid Organizers/Racks	Signs - Hanging or Tent
Drip Trays	Virtuoso™ Coffee Urns & Juice Dispenser
French Press	
Insulated Servers	

Display 130

Angled Adaptor	Display Boards & Easels
Cake/Dessert Stands	Risers, Bowls & Trays-
Display Cases/Covers	Acrylic, Plastic, S/S
Crocks & Covers-Plastic	Roll-Top Food Pan Cover

Bar Supplies 135

AFTER 5™ Barware	Insulated Ice Caddy
Bar Clean-Up	Muddlers & Squeezers
Bar Liners & Service Mats	Moscow Mule Mugs
BAR MAID® Barware	Non-Slip Trays
Bar Speed Rails	Overhead Glass Racks
Blenders	Pour Bottles
Bottle Openers & Corkscrews	Pourers & Stoppers
Condiment Holders	Syrup/Liqueur Pump Kit
Drink Prep & Ice Tools	Wine Service

Kitchen

Prep & Cook

168

Signature Chef™ Apparel 169

Chef Jackets, Shirts, Pants- Multiple Fits & Sizes	Aprons - Bib & Waist Hats - Cloth & Disposable
----------------------------------------------------	------------------------------------------------

Professional Cutlery 183

ACERO™ Forged Cutlery	Protective Gloves
BladeStation™	Sharpening Tools
Cheese Knives, Wires, Graters	Shears-Poultry & Herb
Cook's/Pot Forks	Specialty & Pizza Knives
COOL HEAT™ Turners	STAL™ Stamped Cutlery
Knife Storage/Transport	Steak Knives
Professional Cleavers	Sof-Tek™ Stamped Cutlery

Professional Cookware 209

Aluminum Cookware	Pan Sleeves & Grabbers
Cast Iron Griddles	Roasting Pans
FIREIRON™ Cast Iron Skillets	Stainless Steel Cookware
Fryer & Pasta Baskets	TRI-GEN™ Induction-Ready

Steam Table Pans 236

Adaptor Bars & Plates	Water & Spillage Pans
False Bottoms	Wire Steam Pan Grates
Specialty Pans & Covers	WINCO PRIME™ Bain Maries

Poly Pans & Food Storage 243

Beverage Container	Food Pans & Covers-
Dough Boxes, Covers, Dolly	Clear & White PC
Drain Shelves, Colanders	Ingredient Bins & Lids-
Food Storage Containers-	Mobile, Stackable
Round, Square, Clear, Translucent, White	

Bakeware 250

Baking Mats, Silicone	Mixing Tools-
Batter Dispensers & Funnels	Paddles, Spoons & Bowls
Cake Decorating Tools	Muffin & Loaf Pans
Cake Pans-	Pastry Tools-
Round & Rectangle	Brushes, Blenders, Wheels, Cutters & Molds
Cookie Sheet & Cutters	Rolling Pins
Cooling Racks & Grates	Scrapers-Silicone & Plastic
Dough Preparation-	Spatulas
Boxes & Lids, Proofing Pans, Dockers, Scrapers	Sheet Pans
Doughnut Basket	Sheet Pan Racks
Dredges & Lids	Sifters & Sieves
Leveler, Markers, Cutters	Specialty Pans-
Measuring Tools-	Tart, Bundt, Baguette & Bread Form
Cups, Spoons & Ladles	Springform Pans
	Timers, Oven Mitts, Pot Holders

Pizza Supplies 271

Bubble Poppers	Pan Grippers
Dough Preparation-	Perforated Disks
Boxes, Sifter, Scrapers, Mixing Paddles, Rolling Pins	Pizza Knives/Cutters Pizza Pizza
Dredges & Lids	Pans-Deep Dish, Round, Sicilian & Stackable
Heat Sink	Peels-Aluminum & Wood
Insulated Delivery Bags	Servers & Tongs
Mesh Screens	Tabletop Stand & Rack
Oven Brushes	WinGo Bag™ Delivery Bags

Food Preparation 282

Commercial Can Openers	Mixing Bowls & Stand
Colanders	Pasta Maker
Countertop Juice Squeezers	Salad Spinners
Cutting Boards & Mats	Scales
Dispensers-	STATIKBOARD™ Cutting Boards
Batter & Condiment	Thermometers
Food Mills	Tortilla Press
Mandoline Slicers & Blades	Utility Pail
Manual Prep Tools	

Kitchen Utensils 297

- ALLERGEN-FREE™ Tools**
- Culinary Baskets
- CURV™ S/S Basting Spoons**
- Egg Prep Tools
- Fryer Accessories
- Fruit Prep Tools
- Funnels & Dispensers
- Graters, Zesters & Peelers
- Ladles & Dippers
- CONNOISEUR™ Pasta Baskets**
- Measuring Cups & Spoons
- Meat Prep Tools
- Mesh Strainers, Plastic Handle
- Mixing/Stirring Paddles
- Plating Molds & Utensils
- Protective Gloves
- Scoops & Rack
- Scrapers-Plastic & Nylon
- Serving Tongs-
Poly, Heat-Resistant &
Stainless Steel
- Seafood Prep Tools
- Shears-Herb & Poultry
- Silicone Brush
- Spatulas/Turners
- Spoons-Nylon & Wood
- Squeeze Bottles
- Strainers & Skimmers
- Whips, Stainless Steel
- WINCO PRIME™ Series**

Back of House 340
Clean & Organize

Janitorial 341

- Broom Heads, Handles & Sets
- Brushes - Oven & Utility
- Cleaning Accessories, Towels
- Floor Mats
- FLY-BYE™ Insect Control**
- Gloves & Wall Brackets
- Grill Maintenance
- Hood Filters
- Janitorial Accessories
- Mops & Buckets
- PUR-CLEAN™**
- Restroom Necessities
- Trash Cans, Lids, Dollies,
- Receptacle & Wire Cart

Shelving & Racks 368

- Dunnage Racks
- Security Cage
- Wire Shelving, Sets & Accessories

Bussing & Transport 374

- Bus/Dish Boxes & Carts
- Casters, Universal
- Dish/Tray Caddy
- Flatware Organizers
- Hot/Cold Food Transporters
- Ingredient Bins
- Sheet Pan/Steam Pan Racks
- Wire Dolly
- WinGo Bag™ Delivery Bags**

Equipment 387
Prep, Cook, Hold & Merchandise

Countertop Equipment 388

- BAR MAID® Clean & Sanitize**
- BenchMarkUSA™ Concessions**
- Beverage Dispenser
- Butane Gas Stove, Portable
- Coffee Urns
- Commercial Can Openers
- Concession Equipment & Supplies
- Convection Ovens
- Deep Fryers
- Dump Station Holder, Universal
- Electric Water Pan
- Equipment Stands
- Food Cooker/Warmers
- Heat Lamps
- Heated Merchandisers
- Induction Cooker
- KATTEX™ Slicers & Cutters**
- Merchandisers - Heated &
Refrigerated
- Panasonic® Rice Cooker**
- Pizza Oven, Electric
- Planetary Mixers
- ROLLSRIGHT™**
- Sandwich Grills
- SHOWTIME!™ Concessions**
- Soup Warmers
- SPECTRUM™ -**
- Charbroilers
- Conveyor Toaster
- Griddles
- Hot Dog Roller Grills
- Hot Plates
- Induction Cookers
- Microwaves
- Sous Vide Equipment
- Stock Pot Stove
- Vacuum & Impulse Sealers
- Vacuum Sealing Bags
- Signage, Open, Closed, Etc.
- Strip Heaters
- Waffle Maker, Belgian
- Water Boilers

Index 452

MERCHANDISING DISPLAYS 461

Icons/Symbols

Look for these symbols throughout the catalog:



New product introduced since last catalog



Product is packed in display-ready retail packaging (color box, color blister pack, hang tag, etc.)

Certifications



Product is NSF® certified and complies with all food safety standards



Product is listed in the CSA® Group Certified Product Listing



Product is ETL™ certified for compliance with accepted national safety standards for USA and Canada



Product is ETL™ certified for compliance with sanitation/food safety standards



Product is UL® certified for compliance with safety standards



Product is UL® certified to be compliant with safety standards for U.S.A. and Canada



Product conforms with European standards



Product is color-coded for Allergen-Free



Product does not contain Bisphenol-A (BPA)



Product does not contain Perfluorooctanoic Acid (PFOA)



Product does not contain Polytetrafluoroethylene (PTFE)



Product is compatible with induction cookers

Most orders with less than pallet loads will be shipped by parcel service.

Look for these shipping icons to guide freight evaluations.



Additional oversize fee applies if item ships via parcel service



Item cannot be shipped by parcel service

HAMMERED "CASPIAN" PATTERN FLATWARE

0023-SERIES



Caspian invites light to dance across the hammered ripples...



a versatile choice for any setting.

18/0 Stainless Steel
Medium Weight

- Teaspoon
- Iced Tea Spoon
- Dinner Spoon
- Bouillon Spoon
- Dinner Fork
- Salad Fork
- Oyster Fork
- Dinner Knife

P.48

NEW

WINCO[®] FLATWARE MERCHANDISING DISPLAYS

Get a **FREE DISPLAY** with qualifying order



FRM-SERIES (18/0)



FRM-SERIES (18/8)

- All Winco Flatware Patterns are Available on a Display Board -

No Lost Display Pieces!



Dinner Fork and Spoon attached to retractable reels to feel the weight, finish and ergonomics.

Slatwall or shelf display options - slatwall hooks included.



Ask your Sales Rep for Program Details

BAR MAID[®] - A WINCO[®] BRAND

BAR SUPPLIES:

- Fruit wedger
- Blenders
- Pourers
- Aerators
- Tap Caps & Brushes
- Shooter tubes
- Wristbands
- Bottle Wells
- Glass Washers
- Keg Carts
- Fruit Fly Traps



- SPEED**
- CONSISTENCY**
- PRECISION**
- VERSATILITY**
- MORE PROFIT**



P.139-166

SPECIALTY FRY BASKET - 8 SLOTS

CKCF-BSK



Heavy gauge
18/8 stainless
steel wire



Built-in rail hook

Fry up 8 cutlets
at once!

P.233

Winco[®] **INDUCTION READY**

FIRE IRON[™]

Cookware that gets better with age!



P.220



Premium Food Delivery Bags

"The delivery solution engineered for savings and functionality."



Perfect Temperature Retention

Outstanding Performance

P.280, 385

FRYER ACCESSORIES

CLEANOUT ROD:
SFCR-30



Use to clean out clogged fryer drains

UNIVERSAL FRYER CONNECTOR STRIPS:
SFCS-SERIES

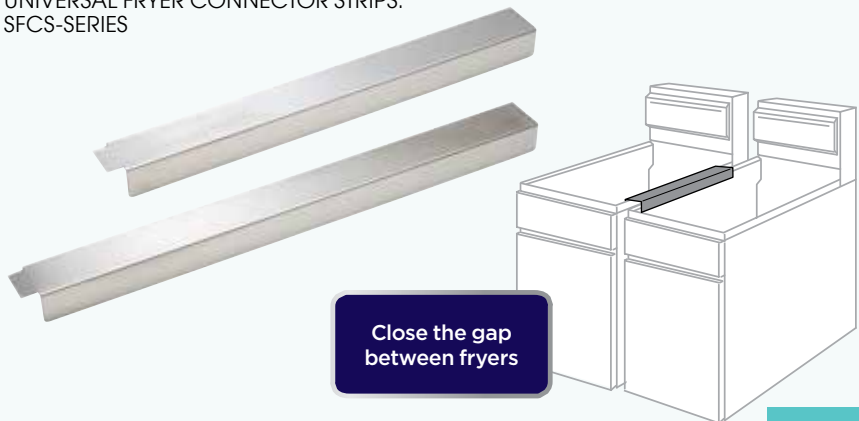

Close the gap between fryers

P.235, 339

EMPANADA FORK PASTRY PRESSES

EF-05
EF-07

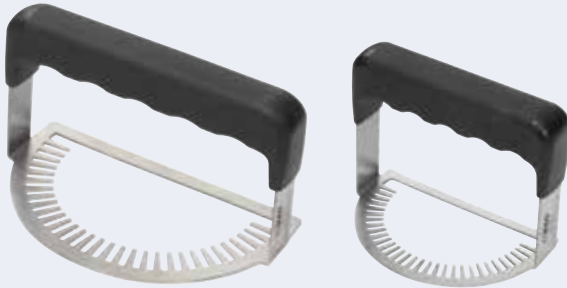

Hello Time and Labor Savings!

P.285, 335

ONE-PIECE SMASHED BURGER PRESS

SWS_6



Get that "Smashed burger crust" every time



Perfectly Weighted

P.336

FOOD TRUCK MOBILE KITCHEN PRODUCT SOLUTIONS

WIN-FT-NP

A **winco**[®] Buying Guide of food equipment and supplies for food truck kitchens.

- Industry snapshot
- Anatomy of a food truck kitchen
- Product solutions



Contact your sales representative and get on the road to success.



CURV™ STAINLESS STEEL BASTING SPOONS

SSCH-SERIES



13" & 15"
PERFORATED,
SLOTTED,
SOLID



P.313

MESH STRAINERS WITH PLASTIC HANDLE

MSTP-SERIES

6", 8", 10"
SINGLE & DOUBLE FINE MESH
SINGLE & DOUBLE MEDIUM MESH



P.327

MERCHANDISING DISPLAY PROGRAM

SLATWALL DISPLAY



Available
with
qualifying
order

See your
sales
rep for
program
details

P.208

WINCO® PRIME SILICONE TONGS

UTSH-SERIES



**Best Materials
Best Value**

Made to endure the most demanding food service environments, Winco Prime products are constructed with quality materials that comply with and exceed accepted industry standards.

Winco Prime products are National Sanitation Foundation (NSF) listed, an assurance of the best food-safe materials and ease of cleaning combined with the famous Winco price/value you expect.



From grill to freezer, these tongs handle the swing in temperature.

Wide range tolerance:
-40°F to 500°F
(-40°C to 260°C)

In COLD
Silicone handles offer insulated handling and resist cracking

In HEAT
Silicone handles for superior burn protection and melt-resistance

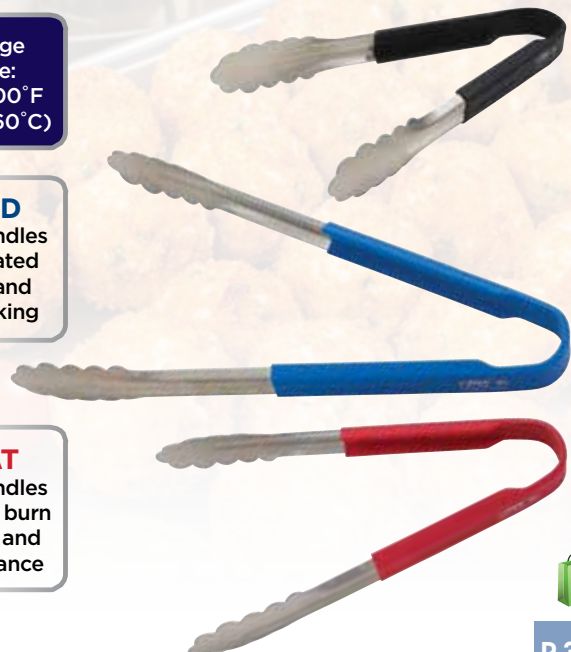

P.306

FLOOR SQUEEGEES

FSS-18DF
FSS-24DF
FSS-DFH



Double-foam blade

Drive Productivity and Promote Safety

Handle sold separately

P.348

MOP HEADS

NEW SIZES

MOP -SERIES

Headband

Tail band

Headband



Brick packed

P.347

MERCHANDISING DISPLAY PROGRAM



Fill with mops, brooms... anything with a handle

Available with qualifying order

MOP & BROOM WINGSTACK



See your sales rep for program details

JANITORIAL CART WITH 25 GALLON BAG & 3 SHELVES

PJC-4538



P.345

MICROFIBER TOWEL PACKS

BTM-16B / -16G / -16R

6-pieces per pack



GREEN

GENERAL
Food Prep & Service Areas
Bar, Tables

BLUE

LOW RISK
Front of House
Door Handles, Railings, Mirrors

RED

HIGH RISK
Hazard Areas
Toilets, Restroom Fixtures

P.167, 357

MICROFIBER TOWEL ROLL & HOLDER

BTM-12B
WHW-12



50 sheets per roll

P.357

URINAL SCREEN

USF-7



Deodorizing protection

P.363

FLY-BYE™ FLOOR DRAIN TRAP SEALS

FB-SERIES

Effectively stops fruit flies and insects from coming up



P.367

WIRE SECURITY CAGE

VCG-SERIES



Locking bar secures door when closed.



Triple-wire anti-pry reinforcement adjacent to thick locking bar.



Wire hook-n-loop door and side panels for extra security.



Panels pre-connected with heavy wire loops, no assembly required.



P.370

BAR MAID® - A WINCO® BRAND

CLEAN & SANITIZE EQUIPMENT



- ✓ **SAVES TIME**
- ✓ **SAVES LABOR**
- ✓ **MORE VERSATILITY**
- ✓ **MORE PROFIT**



GLASSWARE WASHERS



2 YEAR WARRANTY



FLATWARE POLISHERS



GLASSWARE POLISHERS

2 YEAR WARRANTY

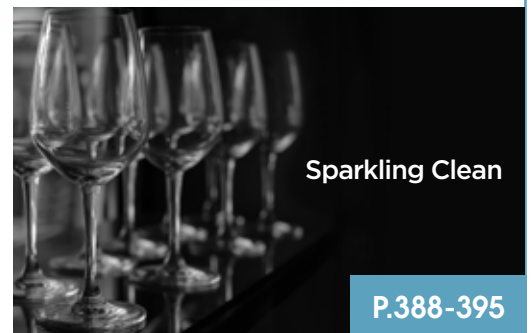

Sparkling Clean

P.388-395



SOUP WARMER

ESW-66-I (INTERNATIONAL)



220V



P.428

BOIL-IN VACUUM SEALER BAGS

EVVPB-SERIES

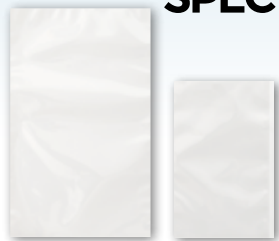

8" X 12"

6" X 8"



P.439

BELGIAN WAFFLE MAKER

BWM-07



UP TO
35
WAFFLES PER HOUR

180° rotation evenly distributes batter



7" Dia fixed non-stick plates

Space saving, compact design



P.440

EQUIPMENT STANDS

EMT-2424
ES-SERIES

Raised edges on 3 sides prevent items slipping off



24" Long

Marine top-edge contains spills

Mixer Stand



24" Long

AVAILABLE
SEPT. 2024

24" TO 60"
LENGTHS

Free up valuable counter space



60" Long



48" Long



P.446,
451



FRONT OF HOUSE

Dining & Service



PORCELAIN

Discover the wide range of porcelain selections from Ardesia™ by Winco® for the perfect setting.



Start a new collection or build on existing tableware with the versatile Ardesia porcelain collections. Clean lines, bright whites and geometric forms inspire culinary creations and presentation. Dishwasher Safe



ZENDO™ *A Touch of Contemporary Linear Embossment*

Bright White Porcelain

ITEM	DESCRIPTION	SIZE	CAPACITY	UOM	QTY/CASE
WDP022-102	Wide Rim Bowl	9" Dia	6 Oz	Case	24-Pcs
WDP022-103	Wide Rim Bowl	10-1/2" Dia	10 Oz	Case	12-Pcs
WDP022-105	Round Plate	6-1/2" Dia		Case	48-Pcs
WDP022-106	Round Plate	8-1/8" Dia		Case	36-Pcs
WDP022-107	Round Plate	9" Dia		Case	24-Pcs
WDP022-108	Round Plate	10" Dia		Case	24-Pcs
WDP022-109	Round Plate	11-1/8" Dia		Case	12-Pcs
WDP022-110	Round Plate	12-1/8" Dia		Case	12-Pcs



OCEA™ *A Combination of Modern and Traditional*

Creamy White Porcelain

ITEM	DESCRIPTION	SIZE	CAPACITY	UOM	QTY/CASE
WDP004-201	Oval Plate	8" L		Case	24-Pcs
WDP004-202	Oval Plate	10" L		Case	24-Pcs
WDP004-203	Oval Plate	12" L		Case	12-Pcs
WDP004-204	Oval Plate	14" L		Case	12-Pcs
WDP004-206	Oval Rim Rnd Bowl	6" Dia	10 Oz	Case	24-Pcs
WDP004-207	Oval Rim Rnd Bowl	8" Dia	20 Oz	Case	24-Pcs
WDP004-208	Oval Rim Rnd Bowl	10" Dia	50 Oz	Case	12-Pcs
WDP004-209	Oval Dish	10" x 7-7/8"		Case	24-Pcs
WDP004-210	Oval Dish	12" x 9-1/8"		Case	12-Pcs
WDP004-211	Oval Dish	14" x 10-1/4"		Case	12-Pcs
WDP004-212	Oval Dish	16" x 12-1/4"		Case	6-Pcs
WDP004-213	Oval Dish	18" x 13-5/8"		Case	6-Pcs





FALETTE™ *The Natural Wave*

Bright White Porcelain

ITEM	DESCRIPTION	SIZE	UOM	QTY/CASE
WDP010-101	Square Plate	9" Sq	Case	12-Pcs
WDP010-102	Square Plate	10" Sq	Case	12-Pcs
WDP010-103	Square Plate	12" Sq	Case	6-Pcs



CRAMONT™ *The Windmill*

Bright White Porcelain

ITEM	DESCRIPTION	SIZE	UOM	QTY/CASE
WDP011-103	Square Plate	9-1/4" Sq	Case	12-Pcs



BETTINI™ *The Timeless Unparalleled Rim*

Bright White Porcelain

ITEM	DESCRIPTION	SIZE	UOM	QTY/CASE
WDP009-101	Square Plate	7-1/2" Sq	Case	24-Pcs
WDP009-102	Square Plate	10-1/2" Sq	Case	12-Pcs
WDP009-103	Square Plate	14" Sq	Case	6-Pcs



MAZARRI™ *The Uniquely Engraved*

Bright White Porcelain

ITEM	DESCRIPTION	SIZE	UOM	QTY/CASE
WDP007-101	Round Plate	10" Dia	Case	12-Pcs
WDP007-103	Round Plate	12" Dia	Case	12-Pcs



CARZOLA™ *The Elevated Creativity*

Bright White Porcelain

ITEM	DESCRIPTION	SIZE	CAPACITY	UOM	QTY/CASE
WDP005-101	Square Bowl	6-1/4" Sq (5-1/2" Dia)	4 Oz	Case	36-Pcs
WDP005-102	Square Bowl	7-3/4" Sq (6-3/4" Dia)	10 Oz	Case	24-Pcs
WDP005-103	Square Bowl	10" Sq (8-1/2" Dia)	22 Oz	Case	12-Pcs



BERGOMI™ *The Cozy Curve*

Creamy White Porcelain

ITEM	DESCRIPTION	SIZE	CAPACITY	UOM	QTY/CASE
WDP006-202	Oval Plate	10-1/4" L		Case	12-Pcs
WDP006-203	Oval Plate	12-1/2" L		Case	12-Pcs
WDP006-204	Oval Bowl	8" L	6 Oz	Case	36-Pcs
WDP006-205	Oval Bowl	11" L	14 Oz	Case	12-Pcs
WDP006-206	Oval Bowl	13" L	20 Oz	Case	12-Pcs





RIMINI™ *The Imperfect Perfection*

Creamy White Porcelain

ITEM	DESCRIPTION	SIZE	CAPACITY	UOM	QTY/CASE
WDP003-201	Angled Bowl	6-1/2" Dia	0.5 Qt	Case	36-Pcs
WDP003-202	Angled Bowl	8-1/4" Dia	1 Qt	Case	12-Pcs
WDP003-203	Angled Bowl	9-1/2" Dia	1.5 Qt	Case	12-Pcs
WDP003-205	Angled Cup	5" Dia x 5"H	8 Oz	Case	24-Pcs



LAURETS™ *The Rounded Square*

Bright White Porcelain

ITEM	DESCRIPTION	SIZE	CAPACITY	UOM	QTY/CASE
WDP008-101	Square Bowl	4-1/2" Sq	9 Oz	Case	24-Pcs
WDP008-102	Square Bowl	6-1/4" Sq	20 Oz	Case	24-Pcs
WDP008-103	Square Bowl	6-3/4" Sq	1 Qt	Case	24-Pcs
WDP008-104	Square Bowl	7-5/8" Sq	1.5 Qt	Case	12-Pcs



CALACATTA™ *Rustic Completion*

Creamy White Porcelain with Marble Effect

ITEM	DESCRIPTION	SIZE	UOM	QTY/PACK
WDP001-203	Rectangular Platter	13-7/8" x 6"	Pack	2-Pcs
WDP001-204	Rectangular Platter	16-1/2" x 7"	Pack	2-Pcs
WDP001-205	Square Platter	6-7/8" Sq	Pack	4-Pcs
WDP001-206	Square Platter	8-1/2" Sq	Pack	4-Pcs
WDP001-207	Square Platter	10-1/4" Sq	Pack	3-Pcs
WDP001-208	Square Platter	11-7/8" Sq	Pack	2-Pcs
WDP001-209	Square Platter	14-1/8" Sq	Pack	2-Pcs



DALMATIA™ *From the Harvest*

Creamy White Porcelain with Wood-Grain Effect

ITEM	DESCRIPTION	SIZE	UOM	QTY/PACK
WDP002-201	Rectangular Platter	12" x 7"	Pack	2-Pcs
WDP002-202	Rectangular Platter	14" x 8-1/8"	Pack	2-Pcs
WDP002-204	Rectangular Platter	15-1/8" x 10-5/8"	Pack	2-Pcs
WDP002-205	Square Platter	10-1/4" Sq	Pack	3-Pcs
WDP002-206	Square Platter	12" Sq	Pack	2-Pcs
WDP002-207	Square Platter	14" Sq	Pack	2-Pcs



VISCA™ *Classic with a Twist of Nature*

Black & White Dual Textured Porcelain

ITEM	DESCRIPTION	SIZE	UOM	QTY/PACK
WDP023-202	Rectangular Platter	13-1/2" x 8-1/2"	Pack	2-Pcs
WDP023-203	Rectangular Platter	15-1/2" x 10"	Pack	2-Pcs
WDP023-204	Square Platter	11" Sq	Pack	2-Pcs
WDP023-205	Square Platter	13" Sq	Pack	2-Pcs



PAREDES™ *Simple Presentation*

Bright White Porcelain

ITEM	DESCRIPTION	SIZE	UOM	QTY/CASE
WDP017-115	Rectangular Platter	12" x 3-3/4"	Case	24-Pcs
WDP017-116	Rectangular Platter	14" x 4-1/2"	Case	24-Pcs
WDP017-117	Rectangular Platter	16-1/4" x 5"	Case	12-Pcs
WDP017-118	Rectangular Platter	17-3/4" x 5-1/2"	Case	12-Pcs
WDP017-119	Rectangular Platter	20-1/4" x 6-1/8"	Case	6-Pcs



LOURES™ *To Accessorize*

Bright White Porcelain

ITEM	DESCRIPTION	SIZE	TOTAL CAPACITY	UOM	QTY/CASE
WDP017-101	Trio Bowl	14-1/4" x 4"	24 oz	Case	24-Pcs
WDP017-102	Trio Bowl	13-1/4" x 5"	50 oz	Case	12-Pcs
WDP017-103	Trio Caddy Bowl	7-3/4" x 5"	10 oz	Case	24-Pcs
WDP017-105	Quartet Bowl	11-7/8" x 3"	7.5 oz	Case	36-Pcs
WDP017-106	Duo Dish	6"L (2-3/4" Dia Each)	2 oz	Case	36-Pcs
WDP017-107	Trio Dish	9-1/2"L (2-3/4" Dia Ea)	3 oz	Case	36-Pcs
WDP017-108	Trio Tray	10" x 5"		Case	24-Pcs
WDP017-110	Oblong Plate	15-1/4" x 6-1/2"		Case	12-Pcs



WDP017-101



WDP017-102



WDP017-103



WDP017-105



WDP017-106



WDP017-107



WDP017-108



WDP017-110

Modern Departure **TALLARO™**
Bright White Porcelain

ITEM	DESCRIPTION	SIZE	UOM	QTY/CASE
WDP017-111	Rectangular Platter	10-1/8" x 7"	Case	24-Pcs
WDP017-112	Rectangular Platter	11-7/8" x 8"	Case	12-Pcs
WDP017-113	Rectangular Platter	13-7/8" x 9-1/4"	Case	12-Pcs
WDP017-114	Rectangular Platter	15-5/8" x 10-5/8"	Case	12-Pcs



LERA™ *Engaging Curves*
Bright White Porcelain

ITEM	DESCRIPTION	SIZE	UOM	QTY/CASE
WDP013-102	Square Dish	4-1/4" Sq	Case	36-Pcs
WDP013-103	Square Dish	5-1/4" Sq	Case	36-Pcs
WDP013-104	Square Dish	6" Sq	Case	36-Pcs



KESTER™ *The Casual Frame*
Bright White Porcelain

ITEM	DESCRIPTION	SIZE	UOM	QTY/CASE
WDP020-101	Square Bowl	5-1/2" Sq	Case	36-Pcs





Mix and Match

MESCALORE™

Bright White Porcelain

ITEM	DESCRIPTION	SIZE	CAPACITY	UOM	QTY/CASE
WDP021-101	Handle Dish, Mini	2-1/2" Dia	1.1 Oz	Case	36-Pcs
WDP021-104	Square Bowl, Mini	2-1/2"	1.5 Oz	Case	36-Pcs
WDP021-106	Rectangle Dish, Mini	4-1/2" x 2-7/8"	3 Oz	Case	36-Pcs
WDP021-107	Rectangle Dish, Sml	5-1/4" x 3-7/8"	4 Oz	Case	36-Pcs
WDP021-109	Trio Tray	13-3/4" x 5"		Case	24-Pcs
WDP021-112	Long Plate, Small	8-1/8" x 3-1/8"		Case	36-Pcs
WDP021-113	Long Plate, Med	9-3/8" x 3-1/2"		Case	36-Pcs
WDP021-114	Long Plate, Large	10-3/8" x 4"		Case	36-Pcs



WDP021-101



WDP021-104



WDP021-106
WDP021-107



WDP021-112
WDP021-113
WDP021-114



WDP021-109



TENORA™ The Stylist Café

Bright White Porcelain

ITEM	DESCRIPTION	SIZE	UOM	QTY/CASE
WDP012-101	Tray	8" x 3-3/4"	Case	36-Pcs
WDP012-102	Tray	10-1/2" x 5"	Case	24-Pcs



EDESSA™ Traditional Charm

Bright White Porcelain

ITEM	DESCRIPTION	SIZE	UOM	QTY/CASE
WDP018-103	Round Dish	8-3/4" Dia	Case	24-Pcs
WDP018-104	Round Dish	11" Dia	Case	12-Pcs



A Memorable Finish **NEWRY™**
Bright White Porcelain

ITEM	DESCRIPTION	SIZE	EACH CAPACITY	UOM	QTY/CASE
WDP016-102	Quartet Tapas Set	9-3/4" x 6-3/4"	5 Oz	Case	12-Sets
WDP015-102	Trio Bowl Set w/ Wooden Plate	9-3/8" x 4"	3 Oz	Case	24-Sets
WDP014-101	Trio Set w/Stand	15" x 3-3/4"	8 Oz	Case	12-Sets
WDP014-102	Trio Set w/Stand	16-1/2" x 4-5/8"	9 Oz	Case	12-Sets



WDP016-102



WDP015-102



WDP014-101



WDP014-102

MELAMINE

Discover the wide range of melamine selections from Ardesia™ by Winco® for the best in durable, every-day settings.

Dishwasher Safe

A Touch of Earth Tone

AVA™

Melamine

ITEM	DESCRIPTION	SIZE	UOM	QTY/CASE
WDM020-401	Round Plate	9" Dia	Case	24-Pcs
WDM020-402	Round Plate	11" Dia	Case	24-Pcs



WDM020-401



WDM020-402

ITEM	DESCRIPTION	COLOR	SIZE	CAPACITY	UOM	QTY/CASE
WDM001-601	Hammered Plate	Yellow	9" Dia		Case	24-Pcs
WDM001-402	Hammered Plate	Blue	11" Dia		Case	24-Pcs
WDM001-502	Hammered Plate	Red	11" Dia		Case	24-Pcs
WDM001-602	Hammered Plate	Yellow	11" Dia		Case	24-Pcs
WDM001-505	Hammered Plate	Red	9-5/8" Dia		Case	24-Pcs
WDM001-605	Hammered Plate	Yellow	9-5/8" Dia		Case	24-Pcs
WDM001-506	Hammered Bowl	Red	7-1/2" Dia	0.8 Qt	Case	24-Pcs
WDM001-407	Hammered Bowl	Blue	13-3/4" Dia	3 Qt	Case	12-Pcs
WDM001-507	Hammered Bowl	Red	13-3/4" Dia	3 Qt	Case	12-Pcs
WDM001-607	Hammered Bowl	Yellow	13-3/4" Dia	3 Qt	Case	12-Pcs
WDM001-508	Rectangular Plate	Red	19" x 8"	0.8 Qt	Case	24-Pcs
WDM001-608	Rectangular Plate	Yellow	19" x 8"	0.8 Qt	Case	24-Pcs



WDM001-506



WDM001-407
WDM001-507
WDM001-607



WDM001-601



WDM001-508
WDM001-608



WDM001-402
WDM001-502
WDM001-602



WDM001-505
WDM001-605



The Salsa Bowl

MILA™
Melamine

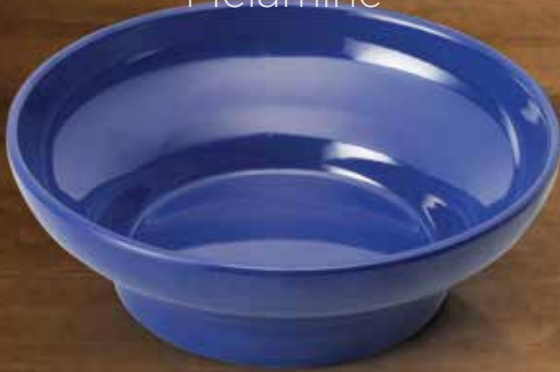

ITEM	DESCRIPTION	COLOR	CAPACITY	UOM	QTY/CASE
WDM008-402	Salsa Bowl	Blue	5 Oz	Case	48-Pcs



WDM008-402



For the Dipper

HARUKI™
Melamine

ITEM	DESCRIPTION	SIZE	CAPACITY	UOM	QTY/CASE
WDM017-301	Square Bowl	2-5/8"	2 Oz	Case	48-Pcs
WDM017-302	Round Bowl	4" Dia	4.5 Oz	Case	48-Pcs



WDM017-301



WDM017-302



The Matte Trinity

NATSUKI™
Melamine

ITEM	DESCRIPTION	SIZE	UOM	QTY/CASE
WDM015-301	Triangular Plate	8-1/8"	Case	24-Pcs
WDM015-302	Triangular Plate	9"	Case	24-Pcs



WDM015-301



WDM015-302

ITEM	DESCRIPTION	SIZE	CAPACITY	UOM	QTY/CASE
WDM019-303	Rectangular Platter	14-1/2" x 6-3/8"		Case	12-Pcs
WDM019-304	Oval Bowl	8-3/4" x 5-3/4"	8 Oz	Case	24-Pcs
WDM019-308	Angled Bowl	9" Dia	23 Oz	Case	12-Pcs



WDM019-303



WDM019-304

WDM019-308



Organically Crafted
KAORI™
Melamine

ITEM	DESCRIPTION	SIZE	CAPACITY	UOM	QTY/CASE
WDM012-303	Bowl	10" Dia	1.75 Qt	Case	24-Pcs
WDM012-305	Bowl	13-1/2" Dia	3.75 Qt	Case	6-Pcs



WDM012-303



Double Texture
KUMATA™
Melamine

ITEM	DESCRIPTION	SIZE	CAPACITY	UOM	QTY/CASE
WDM014-302	Bowl	6-7/8" Dia	22 Oz	Case	24-Pcs
WDM014-303	Bowl	8" Dia	1 Qt	Case	24-Pcs
WDM014-304	Bowl	9" Dia	1.5 Qt	Case	24-Pcs



WDM014-304



The Stacked Coils
TOGASHI™
Melamine

The Concentric Rings

RIKA™
Melamine

ITEM	DESCRIPTION	SIZE	UOM	QTY/CASE
WDM013-301	Square Plate	8-3/4"	Case	24-Pcs
WDM013-302	Square Plate	9-3/4"	Case	24-Pcs
WDM013-303	Square Plate	10-3/4"	Case	24-Pcs
WDM013-305	Square Plate	12-3/4"	Case	12-Pcs
WDM013-306	Square Plate	13-3/4"	Case	12-Pcs



WDM013-301

WDM013-302

WDM013-303



WDM013-305

WDM013-306

The Simplicity Element

LINZA™
Melamine

ITEM	DESCRIPTION	COLOR	SIZE	CAPACITY	UOM	QTY/CASE
WDM009-203	Square Bowl	White	5"	17 Oz	Case	24-Pcs
WDM009-205	Square Bowl	White	10"	5 Qt	Case	6-Pcs
WDM009-302	Square Bowl	Black	3-1/2"	5 Oz	Case	48-Pcs
WDM009-303	Square Bowl	Black	5"	17 Oz	Case	24-Pcs
WDM009-304	Square Bowl	Black	7-1/2"	1.75 Qt	Case	12-Pcs



WDM009-302



WDM009-203
WDM009-303



WDM009-304



WDM009-205

ITEM	DESCRIPTION	SIZE	CAPACITY	UOM	QTY/CASE
WDM005-201	Triangular Bowl	7"	0.75 Qt	Case	24-Pcs
WDM005-202	Triangular Bowl	8"	1 Qt	Case	24-Pcs
WDM005-203	Triangular Bowl	9"	1.25 Qt	Case	24-Pcs
WDM005-204	Triangular Bowl	10"	1.6 Qt	Case	24-Pcs



WDM005-201



WDM005-202



WDM005-204



WDM005-203

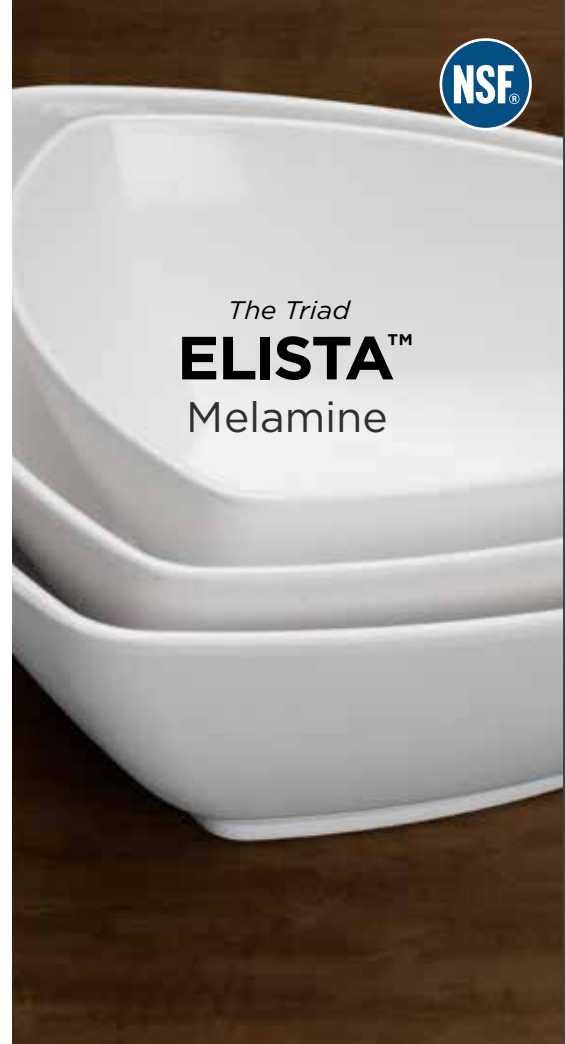

The Triad
ELISTA™
Melamine

ARDESIA™ MELAMINE

ITEM	DESCRIPTION	SIZE	CAPACITY	UOM	QTY/CASE
WDM003-201	Angled Bowl	12" Dia	1.75 Qt	Case	12-Pcs
WDM003-202	Angled Bowl	14" Dia	2.75 Qt	Case	12-Pcs



WDM003-201



WDM003-202

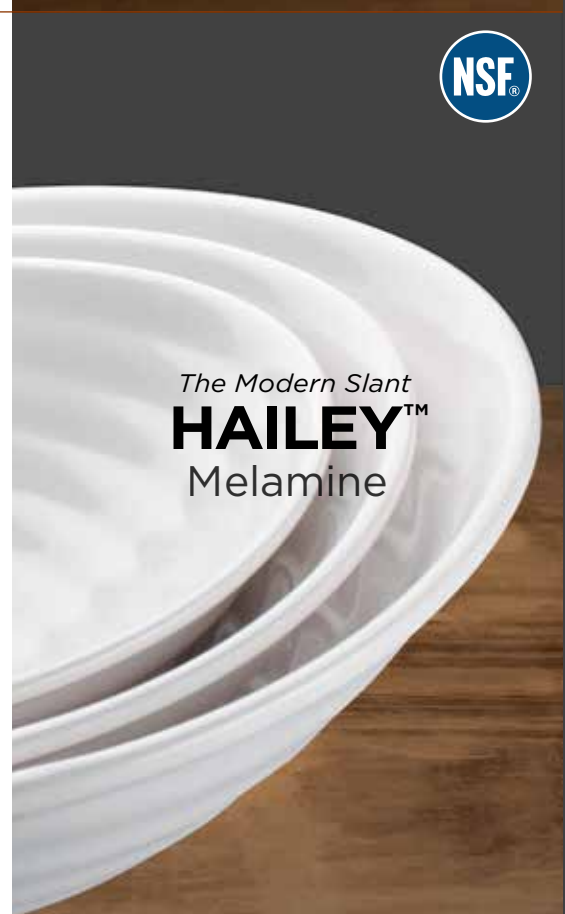

The Modern Slant
HAILEY™
Melamine



The Embossed Spiral
SELENA™
Melamine

ITEM	DESCRIPTION	SIZE	UOM	QTY/CASE
WDM007-201	Triangular Plate	9"	Case	24-Pcs
WDM007-202	Triangular Plate	11"	Case	12-Pcs
WDM007-203	Triangular Plate	13-1/4"	Case	12-Pcs
WDM007-204	Triangular Plate	15-1/4"	Case	12-Pcs



WDM007-201



WDM007-202



WDM007-203



WDM007-204



The Deep Trumpet
PRISCILA™
Melamine

ITEM	DESCRIPTION	SIZE	CAPACITY	UOM	QTY/CASE
WDM004-201	Angled Bowl	6-1/2" Dia	0.5 Qt	Case	24-Pcs
WDM004-202	Angled Bowl	7-1/4" Dia	0.75 Qt	Case	24-Pcs
WDM004-203	Angled Bowl	8-1/2" Dia	1 Qt	Case	24-Pcs



WDM004-201



WDM004-202



WDM004-203

ITEM	DESCRIPTION	SIZE	UOM	QTY/CASE
WDM002-401	Rectangular Platter	20-7/8" x 8"	Case	12-Pcs
WDM002-402	Round Platter	11-7/8" Dia	Case	12-Pcs



WDM002-401

WDM002-402



From Farm to Table
SEMONE™
Melamine

ITEM	DESCRIPTION	SIZE	UOM	QTY/CASE
WDM006-201	Trio Plate	16-3/8" x 5-1/2"	Case	24-Pcs



WDM006-201



The Contemporary Trio
AKILA™
Melamine



Inspire creative plating with **SLATE** serving trays

ITEM	DESCRIPTION	SIZE	UOM	QTY/PACK
WDL001-301	Rectangular Platter	11-1/2" x 4"	Pack	6-Pcs
WDL001-302	Rectangular Platter	11-1/2" x 7-7/8"	Pack	6-Pcs
WDL001-303	Rectangular Platter	15-3/4" x 11-1/2"	Pack	6-Pcs

Hand wash

Clean Slate
TAVO™



WDL001-301



WDL001-302

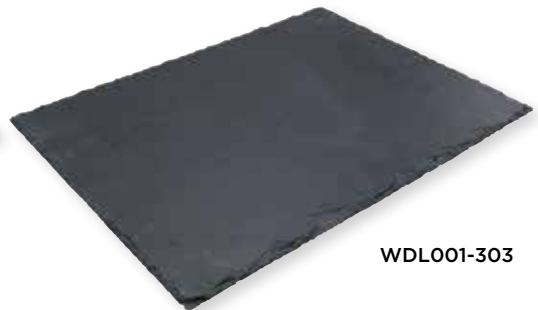

WDL001-303



CLASSIC MELAMINE

Heat resistant up to 212°F (100°C) • Dishwasher safe
Not safe for oven or microwave

Clear plate covers available, see Dining Service



ROUND PLATES

ITEM	SIZE	COLOR	UOM	CASE
MMPR-5	5-1/2" Dia	Tan	Doz	1/8
MMPR-5W	5-1/2" Dia	White	Doz	1/8
MMPR-6	6-3/8" Dia	Tan	Doz	1/4
MMPR-6W	6-3/8" Dia	White	Doz	1/4
MMPR-7	7-1/4" Dia	Tan	Doz	1/8
MMPR-7W	7-1/4" Dia	White	Doz	1/8
MMPR-8	7-7/8" Dia	Tan	Doz	1/4
MMPR-8W	7-7/8" Dia	White	Doz	1/4
MMPR-9	9" Dia	Tan	Doz	1/4
MMPR-9W	9" Dia	White	Doz	1/4
MMPR-10	10" Dia	Tan	Doz	1/2
MMPR-10W	10" Dia	White	Doz	1/2

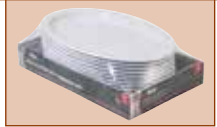

OVAL PLATTERS WITH NARROW RIM

ITEM	SIZE	COLOR	UOM	CASE
MMPO-96	9-3/4"L x 6-3/4"W	Tan	Doz	1/2
MMPO-96W	9-3/4"L x 6-3/4"W	White	Doz	1/2
MMPO-118	11-1/2"L x 8"W	Tan	Doz	1/2
MMPO-118W	11-1/2"L x 8"W	White	Doz	1/2
MMPO-138	13"L x 8-1/2"W	Tan	Doz	1/2
MMPO-138W	13"L x 8-1/2"W	White	Doz	1/2
MMPO-139	13-1/8"L x 9-1/2"W	Tan	Doz	1/4
MMPO-139W	13-1/8"L x 9-1/2"W	White	Doz	1/4
MMPO-1510	15-1/2"L x 10-7/8"W	Tan	Doz	1/2
MMPO-1510W	15-1/2"L x 10-7/8"W	White	Doz	1/2

RECTANGULAR PLATTERS



ITEM	SIZE	COLOR	UOM	CASE
MMPT-96	9-1/2"L x 6-3/4"W	Tan	Doz	1/4
MMPT-117	11-1/2"L x 7-1/2"W	Tan	Doz	1/4
MMPT-129	12-1/2"L x 9"W	Tan	Doz	1/2
MMPT-1510	15"L x 10-5/8"W	Tan	Doz	1/2



RIMLESS BOWLS

ITEM	SIZE	CAPACITY	COLOR	UOM	CASE
MMB-22	6-7/8" Dia	22 oz	Tan	Doz	1/2
MMB-22W	6-7/8" Dia	22 oz	White	Doz	1/2
MMB-32	7-3/8" Dia	32 oz	Tan	Doz	1/4
MMB-32W	7-3/8" Dia	32 oz	White	Doz	1/4
MMB-41	8" Dia	41 oz	Tan	Doz	1/4
MMB-41W	8" Dia	41 oz	White	Doz	1/4
MMB-52	8-1/2" Dia	52 oz	Tan	Doz	1/4
MMB-52W	8-1/2" Dia	52 oz	White	Doz	1/4



NAPPIES

ITEM	SIZE	CAPACITY	COLOR	UOM	CASE
MMB-11	4-3/4" Dia	11 oz	Tan	Doz	1/8
MMB-11W	4-3/4" Dia	11 oz	White	Doz	1/8
MMB-15	5-1/8" Dia	15 oz	Tan	Doz	1/8
MMB-15W	5-1/8" Dia	15 oz	White	Doz	1/8



SOUP/CEREAL BOWLS

ITEM	SIZE	CAPACITY	COLOR	UOM	CASE
MMB-12	6-3/8" Dia	12 oz	Tan	Doz	1/8
MMB-12W	6-3/8" Dia	12 oz	White	Doz	1/8



SAUCE CUPS/RAMEKINS

ITEM	SIZE	CAPACITY	COLOR	UOM	CASE
MMSC-2	2-3/4" Dia	2-1/2 oz	Tan	Doz	1/24
MMSC-2W	2-3/4" Dia	2-1/2 oz	White	Doz	1/24
MMSC-4	3-1/4" Dia	4 oz	Tan	Doz	1/12
MMSC-4W	3-1/4" Dia	4 oz	White	Doz	1/12



MMSC-2



MMSC-2W

BOUILLON CUPS

ITEM	SIZE	CAPACITY	COLOR	UOM	CASE
MMB-8	3-7/8" Dia	8 oz	Tan	Doz	1/4
MMB-8W	3-7/8" Dia	8 oz	White	Doz	1/4



MMB-8



MMB-8W

FRUIT BOWLS

ITEM	SIZE	CAPACITY	COLOR	UOM	CASE
MMB-4	4-5/8" Dia	4 oz	Tan	Doz	1/8
MMB-4W	4-5/8" Dia	4 oz	White	Doz	1/8
MMB-5	4-3/4" Dia	5 oz	Tan	Doz	1/4
MMB-5W	4-3/4" Dia	5 oz	White	Doz	1/4



MMB-4



MMB-5W

GRAPEFRUIT BOWLS

ITEM	SIZE	CAPACITY	COLOR	UOM	CASE
MMB-10	5-1/2" Dia	10 oz	Tan	Doz	1/8
MMB-10W	5-1/2" Dia	10 oz	White	Doz	1/8
MMB-13	5-5/8" Dia	13 oz	Tan	Doz	1/4
MMB-13W	5-5/8" Dia	13 oz	White	Doz	1/4



MMB-13



MMB-13W

BULBOUS MUGS

◆ 3-1/2"L x 2-15/16"W/Dia x 3-5/8"H

ITEM	SIZE	CAPACITY	COLOR	UOM	CASE
MMU-8	2-15/16" Dia	8oz	Tan	Doz	1/4
MMU-8W	2-15/16" Dia	8oz	White	Doz	1/4



MMU-8



MMU-8W

RAMEKIN CUPS

◆ Available fluted or plain; black, bone & white colors

ITEM	DESCRIPTION	CAPACITY	COLOR	UOM	CASE
RFM-1K	Fluted	1-1/2 Oz	Black	Doz	1/8
RFM-1W	Fluted	1-1/2 Oz	White	Doz	1/8
RFM-1B	Fluted	1-1/2 Oz	Bone	Doz	1/8
RFM-2K	Fluted	2 Oz	Black	Doz	1/8
RFM-2W	Fluted	2 Oz	White	Doz	1/8
RFM-2B	Fluted	2 Oz	Bone	Doz	1/8
RFM-3K	Fluted	3 Oz	Black	Doz	1/8
RFM-3W	Fluted	3 Oz	White	Doz	1/8
RFM-3B	Fluted	3 Oz	Bone	Doz	1/8
RFM-4K	Fluted	4 Oz	Black	Doz	1/8
RFM-4W	Fluted	4 Oz	White	Doz	1/8
RFM-4B	Fluted	4 Oz	Bone	Doz	1/8
RP-1K	Plain	1-1/2 Oz	Black	Doz	1/8
RP-1W	Plain	1-1/2 Oz	White	Doz	1/8
RP-1B	Plain	1-1/2 Oz	Bone	Doz	1/8
RP-2K	Plain	2 Oz	Black	Doz	1/8
RP-2W	Plain	2 Oz	White	Doz	1/8
RP-2B	Plain	2 Oz	Bone	Doz	1/8
RP-3K	Plain	3 Oz	Black	Doz	1/8
RP-3W	Plain	3 Oz	White	Doz	1/8
RP-3B	Plain	3 Oz	Bone	Doz	1/8
RP-4K	Plain	4 Oz	Black	Doz	1/8
RP-4W	Plain	4 Oz	White	Doz	1/8
RP-4B	Plain	4 Oz	Bone	Doz	1/8
RP-6K	Plain	6 Oz	Black	Doz	1/8
RP-6W	Plain	6 Oz	White	Doz	1/8
RP-6B	Plain	6 Oz	Bone	Doz	1/8



Fluted Ramekins



RFM-SERIES



Plain Ramekins



RP-SERIES



BLACK



WHITE



BONE

SHANGARILA



With simple and elegant contoured lines, the Shangarila pattern brings an understated sophistication to any setting.

- ◆ 18/8 stainless steel
- ◆ Extra heavyweight
- ◆ Mirror finish
- ◆ 3.0mm thickness dinner fork and spoon

ITEM	DESCRIPTION	LENGTH	UOM	CASE
0030-01	Teaspoon	6"	Doz	1/25
0030-02	Iced Tea Spoon	7-3/8"	Doz	1/25
0030-03	Dinner Spoon	7-1/4"	Doz	1/25
0030-04	Bouillon Spoon	5-7/8"	Doz	1/25
0030-05	Dinner Fork	7-1/4"	Doz	1/25
0030-051	Dinner Fork	7-1/2"	Doz	1/25
0030-06	Salad Fork	6-3/4"	Doz	1/25
0030-07	Oyster Fork	5-11/16"	Doz	1/25
0030-08	Dinner Knife	9-1/4"	Doz	1/15
0030-09	Demitasse Spoon	4-5/8"	Doz	1/25
0030-10	Tablespoon (Euro Length)	8-1/4"	Doz	1/25
0030-11	Table Fork (Euro Length)	8"	Doz	1/25
0030-12	Butter Spreader	6-3/4"	Doz	1/25
0030-15	Hollow Handle Table Knife	9-1/4"	Doz	1/15
0030-16	Steak Knife Pointed Tip	8-7/8"	Doz	1/15
0030-18	European Table Knife	9-3/4"	Doz	1/15
0030-19	Salad Knife	8-7/16"	Doz	1/15

SHANGARILA SERVING PIECES

ITEM	DESCRIPTION	LENGTH	UOM	CASE
0030-21	Large Bowl Serving Spoon	9"	Doz	1/10
0030-22	Cold Meat Serving Fork	8-1/2"	Doz	1/10
0030-23	Solid Serving Spoon	11-1/2"	Doz	1/10
0030-24	Slotted Serving Spoon	11-1/2"	Doz	1/10
0030-25	Banquet Serving Fork	12"	Doz	1/10



PEACOCK



Like its namesake, the sculpted detail of the Peacock pattern blends seamlessly into any elaborate setting.

- ◆ 18/8 stainless steel
- ◆ Extra heavyweight
- ◆ Mirror finish
- ◆ 3.0mm thickness
dinner fork and spoon

ITEM	DESCRIPTION	LENGTH	UOM	CASE
0031-01	Teaspoon	6-1/8"	Doz	1/25
0031-02	Iced Tea Spoon	7-13/16"	Doz	1/25
0031-03	Dinner Spoon	7-9/16"	Doz	1/25
0031-04	Bouillon Spoon	6"	Doz	1/25
0031-05	Dinner Fork	7-13/16"	Doz	1/25
0031-06	Salad Fork	6-3/4"	Doz	1/25
0031-07	Oyster Fork	5-3/4"	Doz	1/25
0031-08	Dinner Knife	8-7/8"	Doz	1/15
0031-09	Demitasse Spoon	4-1/2"	Doz	1/25
0031-10	Tablespoon (Euro Length)	8-3/8"	Doz	1/25
0031-11	Table Fork (Euro Length)	8"	Doz	1/25
0031-12	Butter Spreader	6-3/4"	Doz	1/25
0031-18	European Table Knife	9-5/8"	Doz	1/15

CHANTELLE



Inspired by the Regency era, the delicate flourished lines of the Chantelle pattern add a traditional touch to any setting.

- ◆ 18/8 stainless steel
- ◆ Extra heavyweight
- ◆ Mirror finish
- ◆ 3.0mm thickness
dinner fork and spoon

ITEM	DESCRIPTION	LENGTH	UOM	CASE
0039-01	Teaspoon	6"	Doz	1/25
0039-02	Iced Tea Spoon	7-1/2"	Doz	1/25
0039-03	Dinner Spoon	7-1/4"	Doz	1/25
0039-04	Bouillon Spoon	5-7/8"	Doz	1/25
0039-05	Dinner Fork	7-1/4"	Doz	1/25
0039-06	Salad Fork	6-1/4"	Doz	1/25
0039-07	Oyster Fork	5-5/8"	Doz	1/25
0039-08	Dinner Knife	9-5/16"	Doz	1/15
0039-09	Demitasse Spoon	4-5/8"	Doz	1/25
0039-10	Tablespoon (Euro Length)	8-1/2"	Doz	1/25
0039-11	Table Fork (Euro Length)	8-1/8"	Doz	1/25
0039-12	Butter Spreader	6-3/4"	Doz	1/25

VENICE



Inspired by the water of the floating city, the smooth surface of the Venice pattern brings an understated elegance to any contemporary setting.

- ◆ 18/8 stainless steel
- ◆ Extra heavyweight
- ◆ Mirror finish
- ◆ 3.0mm thickness dinner fork and spoon

ITEM	DESCRIPTION	LENGTH	UOM	CASE
0037-01	Teaspoon	6-1/8"	Doz	1/25
0037-02	Iced Tea Spoon	7-1/4"	Doz	1/25
0037-03	Dinner Spoon	7-3/8"	Doz	1/25
0037-04	Bouillon Spoon	6-1/4"	Doz	1/25
0037-05	Dinner Fork	7-5/8"	Doz	1/25
0037-06	Salad Fork	6-3/4"	Doz	1/25
0037-07	Oyster Fork	5-5/8"	Doz	1/25
0037-08	Dinner Knife	9-1/8"	Doz	1/15
0037-09	Demitasse Spoon	4-1/2"	Doz	1/25
0037-10	Tablespoon (Euro Length)	8-1/4"	Doz	1/25
0037-11	Table Fork (Euro Length)	8-3/8"	Doz	1/25
0037-12	Butter Spreader	6-3/4"	Doz	1/25

DELUXE PEARL



Like a strand of pearls, the delicate beading detail of the Deluxe Pearl pattern is a timeless classic that will enhance any setting.

- ◆ 18/8 stainless steel
- ◆ Extra heavyweight
- ◆ Mirror finish
- ◆ 3.0mm thickness dinner fork and spoon

ITEM	DESCRIPTION	LENGTH	UOM	CASE
0036-01	Teaspoon	6"	Doz	1/25
0036-02	Iced Tea Spoon	7-1/8"	Doz	1/25
0036-03	Dinner Spoon	7-1/4"	Doz	1/25
0036-04	Bouillon Spoon	5-7/8"	Doz	1/25
0036-05	Dinner Fork	7-1/4"	Doz	1/25
0036-06	Salad Fork	7"	Doz	1/25
0036-07	Oyster Fork	5-3/8"	Doz	1/25
0036-08	Dinner Knife	9"	Doz	1/15
0036-09	Demitasse Spoon	4-1/4"	Doz	1/25
0036-10	Tablespoon (Euro Length)	8-1/8"	Doz	1/25
0036-11	Table Fork (Euro Length)	8-1/8"	Doz	1/25
0036-12	Butter Spreader	6-3/4"	Doz	1/25
0036-16	Salad Knife	8-3/8"	Doz	1/25

STANFORD



With a subtle elevated fold down the center of a teardrop-shaped handle, the Stanford pattern brings an elegant touch to a contemporary setting.

- ◆ 18/8 stainless steel
- ◆ Extra heavyweight
- ◆ Mirror finish
- ◆ 3.0mm thickness dinner fork and spoon

ITEM	DESCRIPTION	LENGTH	UOM	CASE
0034-01	Teaspoon	6"	Doz	1/25
0034-02	Iced Tea Spoon	7-5/16"	Doz	1/25
0034-03	Dinner Spoon	7-1/8"	Doz	1/25
0034-04	Bouillon Spoon	6-15/16"	Doz	1/25
0034-05	Dinner Fork	7-1/8"	Doz	1/25
0034-051	Dinner Fork, Extended Length	7-1/4"	Doz	1/25
0034-06	Salad Fork	5-7/8"	Doz	1/25
0034-061	Salad Fork, Extended Length	6-7/8"	Doz	1/25
0034-07	Oyster Fork	5-7/16"	Doz	1/25
0034-08	Dinner Knife	9"	Doz	1/15
0034-09	Demitasse Spoon	4-3/8"	Doz	1/25
0034-10	Tablespoon (Euro Length)	8-5/8"	Doz	1/25
0034-11	Table Fork (Euro Length)	8-5/8"	Doz	1/25
0034-12	Butter Spreader	6-5/8"	Doz	1/25
0034-15	Hollow Handle Dinner Knife	8-3/4"	Doz	1/15
0034-18	Hollow Handle Table Knife	9-5/8"	Doz	1/15

VICTORIA



The simple aristocratic lines of the Victoria pattern make it an ideal choice for a formal setting.

- ◆ 18/8 stainless steel
- ◆ Extra heavyweight
- ◆ Mirror finish
- ◆ 3.0mm thickness
dinner fork and spoon

ITEM	DESCRIPTION	LENGTH	UOM	CASE
0035-01	Teaspoon	6"	Doz	1/25
0035-02	Iced Tea Spoon	7-1/2"	Doz	1/25
0035-03	Dinner Spoon	7-3/8"	Doz	1/25
0035-04	Bouillon Spoon	5-7/8"	Doz	1/25
0035-05	Dinner Fork	7-1/4"	Doz	1/25
0035-06	Salad Fork	6-7/8"	Doz	1/25
0035-07	Oyster Fork	5-9/16"	Doz	1/25
0035-08	Dinner Knife	9-1/4"	Doz	1/15
0035-09	Demitasse Spoon	4-3/8"	Doz	1/25
0035-10	Tablespoon (Euro Length)	8-1/4"	Doz	1/25
0035-11	Table Fork (Euro Length)	8-1/4"	Doz	1/25
0035-12	Butter Spreader	6-3/4"	Doz	1/25
0035-16	Salad Knife	8-1/2"	Doz	1/25

OXFORD



The dignified outline on the fiddle-shaped handle of the Oxford pattern lends a touch of old-fashioned elegance to a setting.

- ◆ 18/8 stainless steel
- ◆ Extra heavyweight
- ◆ Mirror finish
- ◆ 3.0mm thickness dinner fork and spoon

ITEM	DESCRIPTION	LENGTH	UOM	CASE
0033-01	Teaspoon	6-1/4"	Doz	1/25
0033-02	Iced Tea Spoon	7-1/2"	Doz	1/25
0033-03	Dinner Spoon	7-3/8"	Doz	1/25
0033-04	Bouillon Spoon	6"	Doz	1/25
0033-05	Dinner Fork	7-5/8"	Doz	1/25
0033-06	Salad Fork	7"	Doz	1/25
0033-07	Oyster Fork	5-5/8"	Doz	1/25
0033-08	Dinner Knife	9-5/8"	Doz	1/15
0033-09	Demitasse Spoon	4-1/2"	Doz	1/25
0033-10	Tablespoon (Euro Length)	8"	Doz	1/25
0033-11	Table Fork (Euro Length)	8-1/8"	Doz	1/25
0033-12	Butter Spreader	7"	Doz	1/25

CONTINENTAL



The Continental pattern is the moderately priced version of the Shangarila pattern with the same simple contour lines and features.

- ◆ 18/0 stainless steel
- ◆ Extra heavyweight
- ◆ Mirror finish
- ◆ 3.0mm thickness dinner fork and spoon

ITEM	DESCRIPTION	LENGTH	UOM	CASE
0021-01	Teaspoon	6"	Doz	1/25
0021-02	Iced Tea Spoon	7-1/2"	Doz	1/25
0021-03	Dinner Spoon	7-1/4"	Doz	1/25
0021-04	Bouillon Spoon	5-7/8"	Doz	1/25
0021-05	Dinner Fork	7-1/4"	Doz	1/25
0021-06	Salad Fork	6-3/4"	Doz	1/25
0021-07	Oyster Fork	5-5/8"	Doz	1/25
0030-08	Dinner Knife	9-1/4"	Doz	1/15
0021-09	Demitasse Spoon	4-1/8"	Doz	1/25
0021-10	Tablespoon (Euro Length)	8-1/4"	Doz	1/25
0021-11	Table Fork (Euro Length)	8"	Doz	1/25

TOULOUSE



The Toulouse pattern features a fiddle shape handle with a stylish shell motif.

- ◆ 18/0 stainless steel
- ◆ Extra heavyweight
- ◆ Mirror finish
- ◆ 3.0mm thickness dinner fork and spoon

ITEM	DESCRIPTION	LENGTH	UOM	CASE
0006-01	Teaspoon	6-3/8"	Doz	1/25
0006-02	Iced Tea Spoon	7"	Doz	1/25
0006-03	Dinner Spoon	7-3/8"	Doz	1/25
0006-04	Bouillon Spoon	6-3/8"	Doz	1/25
0006-05	Dinner Fork	7-5/8"	Doz	1/25
0006-06	Salad Fork	7"	Doz	1/25
0006-07	Oyster Fork	6"	Doz	1/25
0006-08	Dinner Knife	8-3/4"	Doz	1/25
0006-09	Demitasse Spoon	4-5/8"	Doz	1/25
0006-10	Tablespoon	8-1/4"	Doz	1/25
0006-12	Butter Spreader	7-1/16"	Doz	1/25

The Dots pattern features simple lines and elegant beading details around the handle and neck.

- ◆ 18/0 stainless steel
- ◆ Heavyweight
- ◆ Mirror finish

ITEM	DESCRIPTION	LENGTH	UOM	CASE
0005-01	Teaspoon	6-1/4"	Doz	1/50
0005-02	Iced Tea Spoon	7-1/8"	Doz	1/50
0005-03	Dinner Spoon	7-3/8"	Doz	1/50
0005-04	Bouillon Spoon	6-1/8"	Doz	1/50
0005-05	Dinner Fork	7-3/8"	Doz	1/50
0005-06	Salad Fork	6-1/4"	Doz	1/50
0005-07	Oyster Fork	5-5/8"	Doz	1/50
0005-08	Dinner Knife	8-3/4"	Doz	1/25
0005-09	Demitasse Spoon	4-3/4"	Doz	1/50
0005-10	Tablespoon	8-3/8"	Doz	1/25



The Lafayette pattern features a center ridge with a scalloped accent.

- ◆ 18/0 stainless steel
- ◆ Heavyweight
- ◆ Satin finish

ITEM	DESCRIPTION	LENGTH	UOM	CASE
0015-01	Teaspoon	6"	Doz	1/50
0015-02	Iced Tea Spoon	7-1/4"	Doz	1/50
0015-03	Dinner Spoon	7-1/4"	Doz	1/50
0015-04	Bouillon Spoon	6"	Doz	1/50
0015-05	Dinner Fork	7-5/8"	Doz	1/50
0015-054	Dinner Fork, 4 tines	7-1/2"	Doz	1/50
0015-06	Salad Fork	6-3/4"	Doz	1/50
0015-07	Oyster Fork	5-1/2"	Doz	1/50
0015-08	Dinner Knife	7-3/8"	Doz	1/25
0015-10	Dinner Knife, Hollow Handle	9-1/4"	Doz	1/15
0015-11	Steak Knife, Hollow Handle	9-1/4"	Doz	1/15





The Regency pattern features defined, clean column lines.

- ◆ 18/0 stainless steel
- ◆ Heavyweight
- ◆ Mirror finish

ITEM	DESCRIPTION	LENGTH	UOM	CASE
0007-01	Teaspoon	6"	Doz	1/50
0007-03	Dinner Spoon	7-1/8"	Doz	1/50
0007-04	Bouillon Spoon	5-5/8"	Doz	1/50
0007-05	Dinner Fork	7-3/8"	Doz	1/50
0007-06	Salad Fork	6-1/16"	Doz	1/50
0007-08	Dinner Knife	8-1/2"	Doz	1/25



The Lisa pattern features clean lines and a distinctively raised pitch.

- ◆ 18/0 stainless steel
- ◆ Heavyweight
- ◆ Mirror finish

ITEM	DESCRIPTION	LENGTH	UOM	CASE
0010-01	Teaspoon	6-1/16"	Doz	1/50
0010-03	Dinner Spoon	7-3/4"	Doz	1/50
0010-05	Dinner Fork	7-5/8"	Doz	1/50
0010-08	Dinner Knife	8-1/8"	Doz	1/25

The Winston pattern features a fiddle-shaped handle with a smooth finish.

- ◆ 18/0 stainless steel
- ◆ Heavyweight
- ◆ Satin finish

ITEM	DESCRIPTION	LENGTH	UOM	CASE
0016-01	Teaspoon	6-1/8"	Doz	1/50
0016-02	Iced Tea Spoon	7-3/4"	Doz	1/50
0016-03	Dinner Spoon	7-3/8"	Doz	1/50
0016-04	Bouillon Spoon	6-1/8"	Doz	1/50
0016-05	Dinner Fork	7-1/4"	Doz	1/50
0016-06	Salad Fork	6-1/2"	Doz	1/50
0016-08	Dinner Knife	8-3/8"	Doz	1/25



The Manhattan pattern features subtle grooves on the handle, from neck to mid-section.

- ◆ 18/0 stainless steel
- ◆ Heavyweight
- ◆ Satin finish

ITEM	DESCRIPTION	LENGTH	UOM	CASE
0008-01	Teaspoon	6-1/8"	Doz	1/50
0008-03	Dinner Spoon	6-3/4"	Doz	1/50
0008-04	Bouillon Spoon	6"	Doz	1/50
0008-05	Dinner Fork	7-1/4"	Doz	1/50
0008-08	Dinner Knife	8-1/8"	Doz	1/25





The Elite pattern features a smooth contoured handle with rounded tip.

- ◆ 18/0 stainless steel
- ◆ Heavyweight
- ◆ Mirror finish
- ◆ Available in clear packs

ITEM	DESCRIPTION	LENGTH	UOM	CASE
0026-01	Teaspoon	6"	Doz	1/50
0026-03	Dinner Spoon	7"	Doz	1/50
0026-04	Bouillon Spoon	5-7/8"	Doz	1/50
0026-05	Dinner Fork	7-1/8"	Doz	1/50
0026-06	Salad Fork	6-1/8"	Doz	1/50
0026-08	Dinner Knife	8-5/8"	Doz	1/25

The Heavyweight Pattern ELITE is also available in clear-view packs



The Flute pattern features an elongated oval handle with a smooth finish.

- ◆ 18/0 stainless steel
- ◆ Heavyweight
- ◆ Mirror finish

ITEM	DESCRIPTION	LENGTH	UOM	CASE
0019-01	Teaspoon	5-7/8"	Doz	1/50
0019-03	Dinner Spoon	7-3/16"	Doz	1/50
0019-04	Bouillon Spoon	5-5/8"	Doz	1/50
0019-05	Dinner Fork	7-3/8"	Doz	1/50
0019-06	Salad Fork	6-1/4"	Doz	1/50
0019-08	Dinner Knife	9"	Doz	1/25

The Houston pattern features a fiddle-shaped handle with a turned out collar at the neck.

- ◆ 18/0 stainless steel
- ◆ Heavyweight
- ◆ Satin finish

ITEM	DESCRIPTION	LENGTH	UOM	CASE
0025-01	Teaspoon	6-1/8"	Doz	1/50
0025-03	Dinner Spoon	7-3/16"	Doz	1/50
0025-04	Bouillon Spoon	6"	Doz	1/50
0025-05	Dinner Fork	7-3/8"	Doz	1/50
0025-06	Salad Fork	6-1/8"	Doz	1/50
0025-08	Dinner Knife	8-3/4"	Doz	1/25



The Elegance pattern in mirror finish features embossed floral embellishments with a single motif at the handle tip.

- ◆ 18/0 stainless steel
- ◆ Heavyweight
- ◆ Mirror finish
- ◆ Additional Elegance serving utensils available

ITEM	DESCRIPTION	LENGTH	UOM	CASE
0024-01	Teaspoon	6-1/4"	Doz	1/50
0024-03	Dinner Spoon	7-1/8"	Doz	1/50
0024-04	Bouillon Spoon	6-3/16"	Doz	1/50
0024-05	Dinner Fork	7-3/8"	Doz	1/50



The Elegance pattern in vibro finish features embossed floral embellishments with a single motif at the handle tip.

- ◆ 18/0 stainless steel
- ◆ Heavyweight
- ◆ Vibro finish

ITEM	DESCRIPTION	LENGTH	UOM	CASE
0004-01	Teaspoon	6-3/8"	Doz	1/50
0004-02	Iced Tea Spoon	8"	Doz	1/50
0004-03	Dinner Spoon	7-1/4"	Doz	1/50
0004-04	Bouillon Spoon	6"	Doz	1/50
0004-05	Dinner Fork	7-1/4"	Doz	1/50
0004-06	Salad Fork	6-1/2"	Doz	1/50
0004-07	Oyster Fork	6"	Doz	1/50
0004-08	Dinner Knife	8-5/8"	Doz	1/25
0004-09	Demitasse Spoon	4-1/2"	Doz	1/50
0004-10	Tablespoon	8-3/8"	Doz	1/25





The Caspian pattern invites light to dance across the hammered ripples, a versatile choice for any setting.

- ◆ 18/0 stainless steel
- ◆ Medium weight
- ◆ Hammered finish

ITEM	DESCRIPTION	LENGTH	UOM	CASE
0023-01	Teaspoon	6-3/8"	Doz	1/25
0023-02	Iced Tea Spoon	7-3/4"	Doz	1/25
0023-03	Dinner Spoon	7"	Doz	1/25
0023-04	Bouillon Spoon	6-1/4"	Doz	1/25
0023-05	Dinner Fork	7-7/8"	Doz	1/25
0023-06	Salad Fork	7-1/4"	Doz	1/25
0023-07	Oyster Fork	6"	Doz	1/25
0023-08	Dinner Knife	8-1/2"	Doz	1/15

NEW
Hammered
Pattern

NEW WINCO® FLATWARE MERCHANDISING DISPLAYS

Ask your Sales Rep for Program Details

Get a **FREE DISPLAY** with qualifying order



FRM-SERIES (18/0)



FRM-SERIES (18/8)



- All Winco Flatware Patterns are Available on Display Boards -

The Dominion pattern features an art deco design with two lines down the length of the handle.

DOMINION

- ◆ 18/0 stainless steel
- ◆ Medium weight
- ◆ Vibro finish
- ◆ Also available in clear packs

ITEM	DESCRIPTION	LENGTH	UOM	CASE
0001-01	Teaspoon	5-13/16"	Doz	1/50
0001-02	Iced Tea Spoon	7-7/8"	Doz	1/50
0001-03	Dinner Spoon	7"	Doz	1/50
0001-04	Bouillon Spoon	6"	Doz	1/50
0001-05	Dinner Fork	7-1/8"	Doz	1/50
0001-06	Salad Fork	6-1/8"	Doz	1/50
0001-07	Oyster Fork	5-5/8"	Doz	1/50
0001-08	Dinner Knife	8"	Doz	1/25
0001-09	Demitasse Spoon	4-5/8"	Doz	1/50
0001-10	Tablespoon	7-5/8"	Doz	1/25

- ◆ 18/0 stainless steel
- ◆ Heavyweight
- ◆ Vibro finish

ITEM	DESCRIPTION	LENGTH	UOM	CASE
0014-01	Teaspoon	5-3/4"	Doz	1/50
0014-03	Dinner Spoon	7"	Doz	1/50
0014-04	Bouillon Spoon	5-7/8"	Doz	1/50
0014-05	Dinner Fork	7-1/16"	Doz	1/50
0014-06	Salad Fork	6-1/8"	Doz	1/50
0014-08	Dinner Knife, 55g	7-7/8"	Doz	1/25

The Medium Weight Pattern DOMINION is also available in clear-view packs



The Windsor pattern is a classic that features a smooth contour design.

WINDSOR

- ◆ 18/0 stainless steel
- ◆ Medium weight
- ◆ Vibro finish
- ◆ Also available in clear packs

ITEM	DESCRIPTION	LENGTH	UOM	CASE
0002-01	Teaspoon	5-7/8"	Doz	1/50
0002-02	Iced Tea Spoon	8"	Doz	1/50
0002-03	Dinner Spoon	7"	Doz	1/50
0002-04	Bouillon Spoon	6"	Doz	1/50
0002-05	Dinner Fork	7"	Doz	1/50
0002-06	Salad Fork	6-1/4"	Doz	1/50
0002-07	Oyster Fork	5-1/2"	Doz	1/50
0002-08	Dinner Knife	8"	Doz	1/25
0002-09	Demitasse Spoon	4-5/8"	Doz	1/50
0002-10	Tablespoon	7-5/8"	Doz	1/25

- ◆ 18/0 stainless steel
- ◆ Heavyweight
- ◆ Vibro finish

ITEM	DESCRIPTION	LENGTH	UOM	CASE
0012-01	Teaspoon	5-15/16"	Doz	1/50
0012-03	Dinner Spoon	7"	Doz	1/50
0012-04	Bouillon Spoon	5-7/8"	Doz	1/50
0012-05	Dinner Fork	7-1/16"	Doz	1/50
0012-06	Salad Fork	6-1/8"	Doz	1/50
0012-08	Dinner Knife, 55g	8"	Doz	1/25

The Medium Weight Pattern WINDSOR is also available in clear-view packs



**FLATWARE
IN CLEAR PACKS**



0083-01



0083-05



0083-08



ELITE PATTERN IN CLEAR-VIEW PACKS

- ◆ 18/0 stainless steel
- ◆ Heavyweight
- ◆ Mirror finish

ITEM	DESCRIPTION	LENGTH	UOM	CASE
0083-01	Teaspoon, 2-Doz/Pk	6"	Pack	1/25
0083-05	Dinner Fork, 2-Doz/Pk	7-1/8"	Pack	1/25
0083-08	Dinner Knife, 1-Doz/Pk	8-5/8"	Pack	1/25



DOMINION PATTERN IN CLEAR-VIEW PACKS

- ◆ 18/0 stainless steel
- ◆ Medium weight
- ◆ Vibro finish

ITEM	DESCRIPTION	LENGTH	UOM	CASE
0081-01	Teaspoon, 2-Doz/Pk	5-13/16"	Pack	1/24
0081-02	Iced Tea Spoon, 2-Doz/Pk	7-7/8"	Pack	1/24
0081-03	Dinner Spoon, 2-Doz/Pk	7"	Pack	1/24
0081-04	Bouillon Spoon, 2-Doz/Pk	6"	Pack	1/24
0081-05	Dinner Fork, 2-Doz/Pk	7-1/8"	Pack	1/24
0081-06	Salad Fork, 2-Doz/Pk	6-1/8"	Pack	1/24
0081-07	Oyster Fork, 2-Doz/Pk	5-5/8"	Pack	1/24
0081-08	Dinner Knife, 1-Doz/Pk	8"	Pack	1/24



0081-01



0081-05



0081-08



WINDSOR PATTERN IN CLEAR-VIEW PACKS

- ◆ 18/0 stainless steel
- ◆ Medium weight
- ◆ Vibro finish

ITEM	DESCRIPTION	LENGTH	UOM	CASE
0082-01	Teaspoon, 2-Doz/Pk	5-7/8"	Pack	1/24
0082-02	Iced Tea Spoon, 2-Doz/Pk	8"	Pack	1/24
0082-03	Dinner Spoon, 2-Doz/Pk	7"	Pack	1/24
0082-04	Bouillon Spoon, 2-Doz/Pk	6"	Pack	1/24
0082-05	Dinner Fork, 2-Doz/Pk	7"	Pack	1/24
0082-06	Salad Fork, 2-Doz/Pk	6-1/4"	Pack	1/24
0082-07	Oyster Fork, 2-Doz/Pk	5-1/2"	Pack	1/24
0082-08	Dinner Knife, 1-Doz/Pk	8"	Pack	1/24



0082-01



0082-05



0082-08

GRAPEFRUIT SPOON



SRS-6



STAINLESS STEEL GRAPEFRUIT SPOON

- ◆ Pointed tip and serrated edge easily cuts into citrus fruits

ITEM	DESCRIPTION	LENGTH	UOM	CASE
SRS-6	Grapefruit Spoon, Heavyweight	6-1/4"	Doz	1/25

- ✓ **HIGH-VOLUME**
- ✓ **LOW-RISK**
- ✓ **CONSISTENT RESULTS**



BAR MAID® FLATWARE POLISHERS

Effectively remove spots, streaks, and bacteria from flatware for a sparkling clean and eliminate doubts about the cleanliness of your establishment.

- ◆ Efficient: polish flatware directly from the dishwasher for optimal clean & dry shine
- ◆ Fast ROI: gain significant speed, efficiency, and cost savings over hand-polishing
- ◆ Sanitary: reduces unhygienic handling, and UV-C light kills contaminants for safe service
- ◆ Portable: compact footprint fits most work tables for portable polishing options
- ◆ Spotless Reputation: maintain customer confidence in a clean establishment with spot-free, streak-free, bacteria-free flatware

ITEM	DESCRIPTION	UOM	CASE
CP-3000-D	Flatware Polisher 120V, 3,000-pcs/hour, 22-1/2"L x 20-1/2"W x 17"H	Each	1
CP-7000	Flatware Polisher 120V, 7,000-pcs/hour, 25-1/2"L x 24-1/2"W x 19"H	Each	1
CP-REFILL	Flatware Polisher Granulate Refill, 12-1/2 lb Bag	Each	1

UP TO
7,000
PIECES PER HOUR



CP-7000



BAR MAID® GLASSWARE POLISHERS

On-demand glassware polishing solution that saves on labor, replacement costs, and injury claims.

- ◆ Efficient: warm air flow dries just-washed glassware while polishing
- ◆ Sanitary: reduces unhygienic handling & lint-free
- ◆ Safe: low risk of breakage, reducing injury claims and glassware replacement costs
- ◆ Portable: lightweight and compact footprint with built-in handles for polishing options anywhere
- ◆ Polishing heads are soft and absorbent, removable, and washable

ITEM	OVERALL DIMENSIONS L" x D" x H" (mm)	POWER	PLUG	SHIP WEIGHT
GP-100	12.8 x 11.8 x 19.7 (325 x 300 x 500)	120V-50/60Hz, 1350W, 12.5 A	NEMA 5-15P	38 lbs (17.3 kgs)
GP-3MINI	10.63 x 9.25 x 20.9 (270 x 235 x 530)	110V-50/60 Hz, 1300W, 12.5 A	NEMA 5-15P	33 lbs (14.8 kgs)
GP-3MINI-CE		220V-50/60 Hz	CEE 7/7	

ITEM	DESCRIPTION	UOM	CASE
GP-100	Glass Polisher with 5 Polishing Heads, 120V	Each	1
GP-3MINI	Glass Polisher with 3 Polishing Heads, 110V	Each	1
GP-3MINI-CE	Glass Polisher with 3 Polishing Heads, 220-240V	Each	1

Replacement brushes available



GP-100

2 YEAR WARRANTY

UP TO
350
PIECES PER HOUR



STEAK KNIVES



The only cutlery endorsed by American Master Chefs' Order

ACERO STEAK KNIVES

A Winco® exclusive, these heavyweight knives are a must-have on the tables of any steakhouse. Stainless steel end cap provides excellent balance and control.

- ◆ Full-tang construction for precision and control
- ◆ Crafted of X50 Cr Mo V15 German steel for the ultimate in durability
- ◆ POM injection-molded handle for balanced weight distribution
- ◆ 6-spot advanced polishing allows for a comfortable grip

ITEM	DESCRIPTION	BLADE	UOM	CASE
SK-22	Acero Gourmet Steak Knives, Round Tip	5"	Doz	1/6
SK-12	Acero Gourmet Steak Knives, 12-pc Bulk Pack	5"	Doz	1/6
SK-1	Acero Gourmet Steak Knives, 4-pc Gift Pack	5"	Pack	1/6



NSF SK-22

NSF SK-12

NSF SK-1



4 Piece Boxed Set

JUMBO PLASTIC HANDLE STEAK KNIVES

ITEM	DESCRIPTION	BLADE	UOM	CASE
K-81P	Jumbo Steak Knives, 6-Pcs/Pk	4-3/4"	Pack	6/12
K-85P	Round Tip, Plastic Hdl	5"	Doz	1/12



NSF K-81P

NSF K-85P



K-81P
6-piece Jumbo steak knives

SOLID POM HANDLE STEAK KNIVES

ITEM	DESCRIPTION	BLADE	UOM	CASE
K-70P	Pointed Tip, POM Hdl	5"	Doz	1/24
K-71P	Round Tip, POM Hdl	4-1/2"	Doz	1/24
K-80P	Round Tip, POM Hdl	5"	Doz	1/25



K-70P

K-71P



K-80P

PLASTIC HANDLE STEAK KNIVES

ITEM	DESCRIPTION	BLADE	UOM	CASE
K-60P	Pointed Tip	5"	Doz	1/24
K-50P	Round Tip	5"	Doz	1/48



NSF K-60P

NSF K-50P

EURO SLIM STEAK KNIFE

Offering superior durability and attractive form, ideal for use in commercial venues

- ◆ 12 pieces packaged in hanging clear-view pack

ITEM	DESCRIPTION	BLADE	UOM	CASE
K-73PC	Pointed Tip, ABS Handle, 3 Rivets	4-1/2"	Doz	1/24



Serrated blade



Metal plaque detail



12-piece Euro-slim knives

K-73PC

- ◆ Stainless steel blade for long-lasting durability
- ◆ Durable wood handle

JUMBO WOODEN HANDLE STEAK KNIVES



ITEM	DESCRIPTION	BLADE	UOM	CASE
K-82	Pointed Tip, Polywood Handle, 3 Rivets	4-3/4"	Pack	6/12
KB-15W	Round Tip, Oak Wood Handle	5"	Doz	1/12
KB-30W	Pointed Tip, Oak Wood Handle	5"	Doz	1/12



K-82

6-piece Polywood handle steak knives

WOODEN HANDLE STEAK KNIVES



K-82



KB-15W



KB-30W

WOODEN HANDLE STEAK KNIVES

ITEM	DESCRIPTION	BLADE	UOM	CASE
K-55W	Rounded Tip	4-1/2"	Doz	1/48
K-45W	Pointed Tip	4-1/2"	Doz	1/48
K-438W	Pointed Tip and Handle	4-3/8"	Doz	1/24
K-35W	Economy, Pointed Tip	4"	Doz	1/48



K-35W



K-55W



K-45W



K-438W

- ◆ Hollow handle creates optimal weighted balance for ease of use

ITEM	DESCRIPTION	O.L.	UOM	CASE
0015-10	Lafayette Dinner Knife	9-1/4"	Doz	1/15
0015-11	Lafayette Steak Knife	9-1/4"	Doz	1/15
0030-15	Shangarila Table Knife	9-1/4"	Doz	1/15
0034-15*	Stanford Dinner Knife	8-3/4"	Doz	1/15
0034-18*	Stanford Table Knife	9-5/8"	Doz	1/15

*0034-15 & 0034-18 knives are suitable for any of our 18/8 patterns.



0034-18

HOLLOW HANDLE KNIVES



0015-10



0015-11



0030-15



0034-15

VIRTUOSO

EXTRA
HEAVYWEIGHT
SERIES



Condensation channel contains drips, keeping the service area dry

Create the ultimate modern buffet presentation with the VIRTUOSO collection of premium chafers. Featuring beautiful, clean styling in either all mirror finish stainless steel or gold-tone accented options.

- ◆ Stainless steel mirror finish
- ◆ Roll-top cover opens to 90° or 180°
- ◆ Condensation from cover interior drips into water pan and keeps table surface dry
- ◆ Includes food pan, water pan and fuel holder(s)
- ◆ Stackable for storage

Pair with the matching Virtuoso coffee urns, #905 and #903-Series



101A



101B



103A



103B

ITEM	DESCRIPTION	UOM	CASE
▶ 101A	8 Qt Full-Size, Gold-Tone Accents	Set	1
▶ 101B	8 Qt Full-Size, Stainless Steel	Set	1
▶ 103A	6 Qt Round, Gold-Tone Accents	Set	1
▶ 103B	6 Qt Round, Stainless Steel	Set	1
101-WP	Water Pan for 101A, 101B	Each	1
103-WP	Water Pan for 103A, 103B	Each	5
NSF SPF2	Food Pan for 101A, 101B, NSF	Each	6/12
602-FP	Food Pan for 103A, 103B	Each	12
SPFD-2R	Round Divided Food Pan for 103A, 103B	Each	10
C-F1	Fuel Holder with Cover	Each	12/48



Stackable



Open to 90°



Open to 180°

VINTAGE

**EXTRA
HEAVYWEIGHT
SERIES**



Create the most elegant buffet setting with the VINTAGE collection premium chafers. Each size features a gleaming, mirror finish dome cover, and accented with gold-tone handles and curved legs.

- ◆ Stainless steel mirror finish
- ◆ Roll-top cover opens to 90° or 160°
- ◆ Includes food pan, water pan and fuel holder(s)

ITEM	DESCRIPTION	UOM	CASE
108A	8 Qt Full-Size	Set	1
308A	6 Qt Round	Set	1
108A-WP	Water Pan for 108A	Each	10
602-WP	Water Pan	Each	12
NSF SPF2	Food Pan for 108A, NSF	Each	6/12
602-FP	Food Pan for 308A	Each	12
SPFD-2R	Round Divided Food Pan for 308A	Each	10
C-F1	Fuel Holder with Cover	Each	12/48



108A



Open to 90°

**For All of Your
Catering
Needs
and Beyond**



308A

MADISON
HEAVYWEIGHT SERIES

- ◆ A modern design, perfect for casual and formal settings
- ◆ Stainless steel with highly polished mirror finish dome covers
- ◆ Roll-top covers can stay open at any angle
- ◆ Includes food pan, water pan and fuel holder(s)



601



Full-size chafers are compatible with the electric water pan, #EWP-2

ITEM	DESCRIPTION	UOM	CASE
601	8 Qt Full-Size	Set	1
602	6 Qt Round	Set	1
603	8 Qt Oval	Set	1
C-WPF	Water Pan for 601	Each	6
602-WP	Water Pan for 602	Each	12
603-WP	Water Pan for 603	Each	6
NSF SPF2	Food Pan for 601, NSF	Each	6/12
602-FP	Food Pan for 602	Each	12
SPFD-2R	Round Divided Food Pan for 602	Each	10
603-FP	Food Pan for 603	Each	10
C-F1	Fuel Holder with Cover	Each	12/48



Cover stays open at any angle



602



603





Variety • Value • Casual • Formal



CATERING and BEYOND

HOLIDAYS • EVENTS • CELEBRATIONS



DALLAS
HEAVYWEIGHT SERIES

- ◆ Solid design accented with gold-tone handles
- ◆ Available with lift-off or roll-top cover options
- ◆ Polished stainless steel with mirror finish covers
- ◆ Includes food pan, water pan and fuel holder(s)

ITEM	DESCRIPTION	UOM	CASE
C-5080	8 Qt Full-Size, Roll-top	Set	1
C-RTC	Roll-top Cover for C-5080	Each	1
C-WPF	Water Pan for C-5080	Each	6
NSF SPF2	Food Pan for C-5080, NSF	Each	6/12
C-F1	Fuel Holder with Cover	Each	12/48



C-5080



Roll-top cover open

BELLAIRE FOLDING CHAFER
HEAVYWEIGHT SERIES

- ◆ Stainless steel with built-in clips to hold covers in place for easy and convenient refilling and serving
- ◆ Solid, stable foldable frame
- ◆ Includes water pan, food pan, foldable frame & two fuel can holders

ITEM	DESCRIPTION	UOM	CASE
C-1080	8 Qt Full-Size	Set	1
C-WPF	Water Pan for C-1080	Each	6
NSF SPF2	Food Pan for C-1080, NSF	Each	6/12
C-F1	Fuel Holder with Cover	Each	12/48



C-1080



Clips hold cover while serving



C-1080 Folding Frame

- ◆ Elegance combined with ornate details; the Crown collection is designed exclusively for formal settings
- ◆ Stainless steel mirror finish
- ◆ Sculpted handles and legs
- ◆ Includes food pan, water pan and fuel holder(s)

CROWN
MEDIUM-WEIGHT SERIES

ITEM	DESCRIPTION	UOM	CASE
408-1	8 Qt Full-Size	Set	1
508	4 Qt Half-Size, Square	Set	1
708	6 Qt Round	Set	1
C-WPF	Water Pan for 408-1	Each	6
508-WP	Water Pan for 508	Each	6
708-WP	Water Pan for 708	Each	1/12
NSF SPF2	Food Pan for 408-1, NSF	Each	6/12
508-FP	Food Pan for 508	Each	10
708-FP	Food Pan for 708	Each	1/6
C-F1	Fuel Holder with Cover	Each	12/48



408-1



708



508

- ◆ Classic art deco design with gold-tone accents
- ◆ Polished stainless steel with mirror finish covers
- ◆ 8 quart full-size chafer features a frame clip for the cover
- ◆ Includes food pan, water pan and fuel holder(s)

MALIBU
MEDIUM-WEIGHT SERIES

ITEM	DESCRIPTION	UOM	CASE
201	8 Qt Full-Size	Set	1
202	6 Qt Oval	Set	1
203	4 Qt Round	Set	1
C-WPF	Water Pan for 201	Each	6
202-WP	Water Pan for 202	Each	12
203-WP	Water Pan for 203	Each	12
NSF SPF2	Food Pan for 201, NSF	Each	6/12
202-FP	Food Pan for 202	Each	12
203-FP	Food Pan for 203	Each	12
C-F1	Fuel Holder with Cover	Each	12/48



201



203



202

GET-A-GRIP™
PATENTED HANDLE SYSTEM

- ◆ Simple design with patented food pan that features safety handles, preventing steam burns
- ◆ Clips on frame conveniently hold cover when open
- ◆ Includes water pan, specially designed food pan and two fuel holders

ITEM	DESCRIPTION	UOM	CASE
C-2080B	8 Qt Full-Size	Set	1
C-WPF	Water Pan for C-2080B	Each	6
SPF2-HD	Food Pan with Handle for C-2080B	Each	6
C-F1	Fuel Holder with Cover	Each	12/48



C-2080B



Patented Get-A-Grip™ handle system



Clips hold cover in place while serving

NEWBURG
ECONOMY-WEIGHT SERIES

- ◆ Simple, elegant and functional design
- ◆ Clips on frame conveniently hold cover when open
- ◆ High legs allow for extra space to prevent fuel holder bottoms from overheating table surface
- ◆ Includes water pan, food pan, two fuel holders and plastic handle

ITEM	DESCRIPTION	UOM	CASE
C-3080B	8 Qt Full-Size	Set	1
C-WPF	Water Pan for C-3080B	Each	6
NSF SPF2	Food Pan for C-3080B, NSF	Each	6/12
C-F1	Fuel Holder with Cover	Each	12/48



C-3080B



Clips hold cover while serving

This folding chafer is lightweight for maximum mobility.

- ◆ Constructed of stainless steel with built-in clips to hold covers in place for easy and convenient refilling and serving
- ◆ Includes water pan, food pan, frame & two fuel holders

FOLDING CHAFER **ECONOMY-WEIGHT SERIES**

ITEM	DESCRIPTION	UOM	CASE
C-4080	8 Qt Full-Size	Set	1
C-WPF	Water Pan for C-4080	Each	6
SPF2	Food Pan for C-4080, NSF	Each	6/12
C-F1	Fuel Holder with Cover	Each	12/48



C-4080 Set



C-4080 Folding Frame



C-4080



CATERING
and **BEYOND**

HOLIDAYS
EVENTS
CELEBRATIONS

CHAFING PAN HOLDERS

Convenient, sturdy, and reusable chafing pan solutions

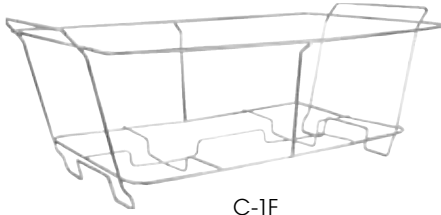

C-1F



CHAFFER STAND FOR ALUMINUM FOIL TRAYS

- ◆ Time-saving, reusable solution for quick set up and clean-up
- ◆ Fits a full-size disposable steam pan
- ◆ Built-in supports hold 2 fuel cans
- ◆ Complete with handles for easy transport

ITEM	DESCRIPTION	UOM	CASE
C-1F	Full-Size Wire Stand	Each	30

Replaces C-2F



CHAFFER STAND FOR STEAM PANS & WATER PANS

- ◆ Fits steam table pans and water pans only
- ◆ Do not use with aluminum foil pans

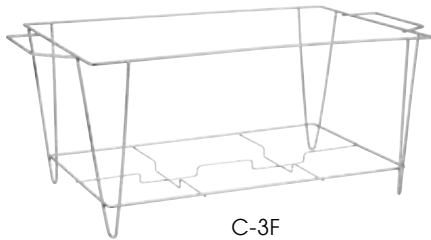

C-3F

ITEM	DESCRIPTION	UOM	CASE
C-3F	Full-Size Wire Stand	Each	10



HEAT BOOST TWIST-CAP CHAFING FUEL CANS



HEAT BOOST TWIST-CAP CHAFING FUEL CANS

Reusable wick-type fuel cans fit any standard chaffer fuel holder.

- ◆ Diethylene glycol fuel; odorless
- ◆ Twist-cap for easy open and secure close for transport and storage
- ◆ Wick-type, reusable, able to relight
- ◆ Available in 2- / 4- / 6-hour burn times
- ◆ Sold in full case only



C-F2



C-F6

ITEM	DESCRIPTION	UOM	CASE
C-F2	Chafing Fuel, 2 Hour Burn Time	Each	24
C-F4	Chafing Fuel, 4 Hour Burn Time	Each	24
C-F6	Chafing Fuel, 6 Hour Burn Time	Each	24



ELECTRIC WATER PAN - 900WATTS

Add ease and convenience with this versatile, energy efficient 120 Volt alternative to chafing fuels. It fits most full-size chafer stands or use as a freestanding unit.

- ◆ Stands alone or fits standard full-size chafer frames for an electric alternative (food pan sold separately)
- ◆ Accommodates full-size steam table pans
- ◆ Powerful, efficient 900W heating element warms faster; temperature is adjustable
- ◆ 120V~60Hz, 900W, 7.5A
- ◆ Dimensions: 22-5/8"L x 13-5/8"W x 7"H

ITEM	DESCRIPTION	UOM	CASE
EWP-2	900W, Full Size	Each	1

ELECTRIC FULL SIZE WATER PAN



EWP-2



Holds a full-size steam table pan and fits in standard full-size chafers

STAINLESS STEEL SOUP WARMERS

Enhance the look of a serving table with these stainless steel chafer-style soup warmers.

- ◆ Includes cover, water pan and fuel can holder

ITEM	DESCRIPTION	UOM	CASE
211	11 Qt Warmer	Set	1
207	7 Qt Warmer	Set	1
211-WP	Water Pan for 211	Each	12
207-WP	Water Pan for 207	Each	12
INSC-11M	Cover For 11 Qt Inset	Each	6/36
INSC-7M	Cover For 7 Qt Inset	Each	6/48
INSH-11	Hinged Cover For 11 Qt Inset	Each	6/24
INSH-7	Hinged Cover For 7 Qt Inset	Each	6/24
C-F1	Fuel Holder with Cover	Each	12/48

SOUP WARMERS



211



207



winco
SPECTRUM™
DROP-IN INDUCTION COOKERS



EIDS-SERIES

Control panel mounts to front of counter where drop-in cooker is installed



Drop-in induction cooker mounted in counter

  EIDS-18
 For U.S. only

  EIDS-18C
 EIDS-34
 For U.S. and Canada



EIDS-TR

DROP-IN INDUCTION COOKERS

Great for front-of-the-house display cooking, this induction range eliminates the need for open flames and helps reduce the amount of heat in the room for a safer, more comfortable cooking environment.

- ◆ Powder-coated steel body construction
- ◆ Compact drop-in-counter design that can be flush, recessed, or mounted with optional trim ring
- ◆ Easy to use digital control with ten (10) power wattage levels from warming to cooking for optimal cooking efficiency, control and speed
- ◆ Remote control panel provided with 36" (915mm) quick-connect cord
- ◆ High-impact and high-heat resistant 11-13/16" x 11-13/16" (299mm x 299mm) glass-ceramic cooking surface
- ◆ Accommodates pan sizes between 4-1/2" (114 mm) to 10-1/2" (267mm)
- ◆ Small-article and pan detection
- ◆ Timer up to 150 min (2-1/2 hours)
- ◆ Auto safety shut-off

ITEM	OVERALL DIMENSIONS L" X D" X H" (mm)	POWER	PLUG	SHIP WEIGHT
EIDS-18	12-5/8 x 13-7/16 x 3-7/8 (320 x 340 x 98)	120V~60Hz, 1800W, 15A	NEMA 5-15P	27.7 lbs (12.6 kgs)
EIDS-18C		120V~60Hz, 1800W, 15A	NEMA 5-20P	
EIDS-34		240V~60Hz, 3400W, 14A	NEMA 6-20P	

ITEM	DESCRIPTION	UOM	CASE
EIDS-18	US	Set	1/2
EIDS-18C	US and Canada	Set	1/2
EIDS-34	US and Canada	Set	1/2

TRIM RING FOR DROP-IN INDUCTION COOKERS

For a sleek look, install the drop-in induction cookers with this additional trim ring to protect the glass edges and hide the countertop cutout.

ITEM	DESCRIPTION	UOM	CASE
EIDS-TR	Stainless Steel Trim Ring	Each	1

ECONOMY INDUCTION COOKER

Low profile



ECONOMY COUNTERTOP INDUCTION COOKER

- ◆ Up to 1800 watts of continuous heat to cook everything from a low simmer to a rolling boil
- ◆ Easy-touch controls with adjustable power levels (1-10)
- ◆ Ceramic glass surface with small-article and pan detection, 4-3/4"-10-1/4" induction cookware
- ◆ Durable stainless steel and plastic body construction
- ◆ Timer up to 180 min (3 Hours)

OVERALL DIMENSIONS L" x D" x H" (mm)	POWER	PLUG	SHIP WEIGHT
11-3/4 x 15-3/4 x 2-3/4 (299 x 400 x 70)	120V~60Hz, 1800W, 15A	NEMA 1-15P	13.3 lbs (6 kgs)

ITEM	DESCRIPTION	UOM	CASE
EIC-400E	Induction Cooker	Each	1/4

  EIC-400E
 For U.S. only

COUNTERTOP INDUCTION COOKERS

A mobile option for front-of-the-house display cooking, this induction range eliminates the need for open flames and helps reduce the amount of heat in the room for a safer, more comfortable cooking environment.

- ◆ Stainless steel body construction
- ◆ Compact, easy-to-clean, portable
- ◆ Easy to use digitally controlled wattage and temperature from warming to cooking for optimal cooking efficiency, control and speed
- ◆ High-impact and high-heat resistant 11-13/16" x 11-13/16" (299mm x 299mm) glass-ceramic cooking surface
- ◆ Accommodates pan sizes between 4-1/2" (114 mm) to 10-1/2" (267mm)
- ◆ Small-article and pan detection
- ◆ Timer up to 150 min (2-1/2 hours)
- ◆ Auto safety shut-off

ITEM	OVERALL DIMENSIONS L" X D" X H" (mm)	POWER	PLUG	SHIP WEIGHT
EICS-18	14- ³ / ₁₆ " x 18- ¹ / ₈ " x 5- ¹ / ₈ " (360 x 460 x 129)	120V~60Hz, 1800W, 15A	NEMA 5-15P	37.5 lbs (17 kgs)
EICS-18C		120V~60Hz, 1800W, 15A	NEMA 5-20P	
EICS-34		240V~60Hz, 3400W, 14A	NEMA 6-20P	

ITEM	DESCRIPTION	UOM	CASE
EICS-18	US	Set	1/2
EICS-18C	US and Canada	Set	1/2
EICS-34	US and Canada	Set	1/2

winco® SPECTRUM™ COUNTERTOP INDUCTION COOKERS

Heat Efficiency Comparison

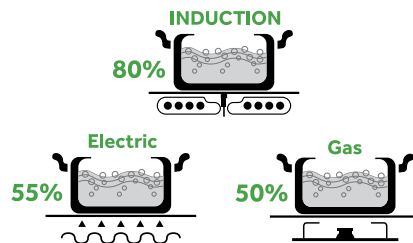

Using with SSOP Pan

Compatible with
induction-ready
cookware

EICS-18  For U.S. only

EICS-18C  For U.S. and Canada

EICS-34  For U.S. and Canada

STAINLESS STEEL DISPLAY PANS

- ◆ Tri-ply base for even heat distribution
- ◆ Induction compatible
- ◆ Riveted handles for durability

ITEM	DESCRIPTION	SIZE (DIA X H)	UOM	CASE
SSOP-12	12-1/2"	12-1/2" x 2-1/4"	Each	1/2

PREMIUM DISPLAY PANS



SSOP-12  

VIRTUOSO™ COFFEE URNS & JUICE DISPENSER

Modern design, coordinates with Virtuoso chafers.

VIRTUOSO™ COFFEE URNS

- ◆ Extra-heavyweight mirror-finish stainless steel
- ◆ Available with gold-tone accents or all stainless steel
- ◆ Either 3 gallon (11.3L) or 5 gallon (18.9L) capacities



905A



905B

Coordinate with the matching Virtuoso chafers, #101 and #103-Series

ITEM	DESCRIPTION	UOM	CASE
905A	5 Gal (18.9L), Two-Tone	Set	1
905B	5 Gal (18.9L), Stainless Steel	Set	1
903A	3 Gal (11.3L), Two-Tone	Set	1
903B	3 Gal (11.3L), Stainless Steel	Set	1
FAUCET-CU	Stainless Steel Faucet	Each	1
FAUCET-JD	Plastic Faucet	Each	1



903A



903B



FAUCET-CU



FAUCET-JD



908



VIRTUOSO™ JUICE DISPENSER WITH ICE CORE

- ◆ Break-resistant, clear plastic container provides excellent product visibility
- ◆ Mirror finish stainless steel base, core and lid
- ◆ 11-1/2"L x 13-1/2"W x 21"H
- ◆ 6-1/2" high base

ITEM	DESCRIPTION	UOM	CASE
908	3 Gal (11.3L), Mirror S/S	Set	1



Chill with ice core

Cool & refreshing

DRIP TRAYS

Place beneath beverage dispenser faucets to catch and collect drips, minimizing mess.

NEW

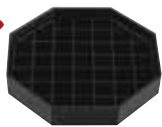

CR-1451B



- ◆ Removable grid for easy cleaning
- ◆ Dishwasher safe

BAR MAID® DRIP TRAYS

ITEM	DESCRIPTION	UOM	CASE
CR-1451B	4-1/2" Tray	Box	12/144
CR-1440	6" Tray	Each	12/72



DT-45



DT-60

DRIP TRAYS

ITEM	DESCRIPTION	UOM	CASE
DT-45	4-1/2" Tray, 4 pcs/pk	Pack	12/24
DT-60	6" Tray, 4 pcs/pk	Pack	12/24

NSF

BPA FREE

DT-SERIES

New Item

- ◆ Ice core allows chilling without watering down
- ◆ Break-resistant polycarbonate containers
- ◆ Removable container and drip tray for easy cleaning

COLD BEVERAGE DISPENSERS

PEDESTAL JUICE DISPENSERS WITH ICE CORE

- ◆ Mirror finish; available with either gold-tone accents or all stainless steel details
- ◆ Break-resistant, clear plastic container provides excellent product visibility
- ◆ 10-1/8"L x 13-3/4"W x 21-1/4"H

ITEM	DESCRIPTION	UOM	CASE
901	2.2 Gal (8.3L), Two-Tone	Set	1
902	2.2 Gal (8.3L), Stainless Steel	Set	1



902

901

ACCESSORIES FOR JUICE DISPENSERS

ITEM	DESCRIPTION	UOM	CASE
901-FN	Faucet for 901, 902	Each	12/48
901-P1	Container for 901, 902	Each	4



901-P1



901-FN

COLD BEVERAGE DISPENSER WITH ICE CORE AND HANDS-FREE FAUCET

- ◆ Break-resistant, clear plastic container provides excellent product visibility
- ◆ Brushed finish stainless steel base, core and lid
- ◆ Tight-fitting lid keeps contents free from contaminants
- ◆ 9-1/8"L x 10"W x 22"H
- ◆ Detachable 8" high base

ITEM	DESCRIPTION	UOM	CASE
904	2.25 Gal (8.5L), Brushed S/S	Set	1/4
904-F	Hands-Free Faucet	Each	30



With
HANDS-FREE
Faucet



904

Cool & refreshing, not watered down



904-F



Fill center tube with ice to chill drinks without watering them down

PUNCH BOWL



SPB-35

STAINLESS STEEL PUNCH BOWL WITH HANDLES

- ◆ Elegantly serve a variety of spiced, fruity, fizzy punches or mocktails out of this large jorum
- ◆ Mirror finish with wide footed base

ITEM	DESCRIPTION	UOM	CASE
SPB-35	3-1/2 Gal (13.25L)	Each	6



STANDING & HANGING SIGNS



SGN-SERIES TENT SIGNS

STAINLESS STEEL STANDING TENT SIGNS

Compact size, ideal for tabletops.

- ◆ 3"L x 1-1/2"D x 1-1/4"H
- ◆ Highly visible bold lettering

ITEM	DESCRIPTION	UOM	CASE
SGN-100	Blank Sign	Each	12/120
SGN-101	Hot Tea	Each	12/120
SGN-102	Decaf	Each	12/120
SGN-103	Coffee	Each	12/120
SGN-104	Hot Water	Each	12/120
SGN-105	Iced Tea	Each	12/120
SGN-106	Sanitized	Each	12/120



SGN-SERIES HANGING SIGNS

STAINLESS STEEL HANGING SIGNS

- ◆ 3-1/2"L x 1-3/4"W sign with 12" long chain

ITEM	DESCRIPTION	UOM	CASE
SGN-202	Decaf	Each	12/120
SGN-203	Coffee	Each	12/120
SGN-204	Hot Water	Each	12/120
SGN-205	Iced Tea	Each	12/120

CLIPS & HOLDERS

MENU / TABLE SIGN CLIPS

ITEM	DESCRIPTION	SIZE	UOM	CASE
MH-1	Harp Clip, Heavy-Cast Base	1"L x 1"W x 1-1/2"H	Doz	10/60
MH-2	Ring-Type	2-1/2" x 2-1/3"	Doz	2/20
MH-2C	Clip	2-1/2" x 2-1/2"	Doz	1/40



MH-1



MH-2



MH-2C

- ◆ Durable and stable surface for displaying
- ◆ 18/8 stainless steel in a mirror-finish glossy ripple effect
- ◆ Showcase appetizers and desserts

DISPLAY TRAYS

ITEM	DESCRIPTION	SIZE	UOM	CASE
HPS-10	Square	10-1/4" x 10-1/4" x 5/8"	Each	12
HPR-8	Round	8-7/8"Dia x 1-5/8"	Each	12
HPR-9	Round	9-5/8"Dia x 1-5/8"	Each	12
HPR-10	Round	10-1/4"Dia x 1-5/8"	Each	12

DISPLAY TRAYS

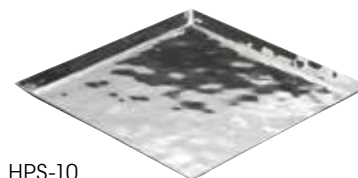

HPS-10



HPR-10

CHROME SERVING TRAYS

The classic gadroon edge and traditional engraving of these chrome-plated trays are perfect for tea and coffee service, as well as pastries, appetizers and desserts.

- ◆ Hand wash only

ITEM	DESCRIPTION	SIZE	UOM	CASE
CMT-1912	Rectangular with Handles	19-1/2" x 12-1/2"	Each	12/24
CMT-1217	Octagonal	17" x 12-1/2"	Each	12/24
CMT-1420	Octagonal	20" x 14"	Each	12/24
CMT-1812	Rectangular	18" x 12-1/2"	Each	12/24
CMT-2014	Rectangular	20" x 14"	Each	12/24
CMT-1014	Oval	14-3/4" x 10-1/2"	Each	12/24
CMT-1318	Oval	18-3/4" x 13"	Each	12/24
CMT-14	Round	14"	Each	12/24

CHROME SERVING TRAYS



CMT-1912



CMT-1420



CMT-14



CMT-1318



CMT-2014

**STAINLESS STEEL
BUFFET SERVICE**



BW-NS3 BW-SL2 BW-SS1 BW-BF BW-CF



BW-PS5 BW-WPS6 BW-DL BW-DK8 BW-DK9 BW-SP1 BW-SP2 BW-TN

STAINLESS STEEL HOLLOW HANDLE BUFFETWARE

Made of durable, one-piece stainless steel providing comfort and style.

ITEM	DESCRIPTION	LENGTH	UOM	CASE
BW-NS3	Notched Spoon	11-3/4"	Each	12/72
BW-SL2	Slotted Spoon	11-3/4"	Each	12/72
BW-SS1	Solid Spoon	11-3/4"	Each	12/72
BW-BF	Pot Fork, Two Tines	11"	Each	12/72
BW-CF	Cold Meat Fork	10"	Each	12/72
BW-PS5	Pie Server	11"	Each	12/72
BW-WPS6	Wide Pie Server	11-1/2"	Each	12/72
BW-DL	Deep Ladle	4 Oz	Each	12/72
BW-DK8	Carving Knife, Wave-Edge Blade	8"	Each	12/72
BW-DK9	Slicer/Wedding Cake Knife, Wave-Edge	9"	Each	12/72
BW-SP1	Spout Ladle	1 Oz	Each	12/72
BW-SP2	Spout Ladle	2 Oz	Each	12/72
BW-TN	Perforated Turner	14"	Each	12/72

STAINLESS STEEL SERVING SPOONS



SRS-2

SRS-8

ITEM	DESCRIPTION	LENGTH	UOM	CASE
SRS-2	Round Edge	8-5/8"	Doz	1/25
SRS-8	Flat Edge	8-1/4"	Doz	1/25

STAINLESS STEEL SPAGHETTI SERVERS



STS-9

STS-13

ITEM	DESCRIPTION	LENGTH	UOM	CASE
STS-9	Small	9"	Each	12/144
STS-13	Large	13"	Each	12/144

SHANGARILA 18/8 STAINLESS STEEL SERVING PIECES

◆ Extra-heavyweight, mirror-finish

ITEM	DESCRIPTION	LENGTH	UOM	CASE
0030-21	Large Bowl Serving Spoon	9"	Doz	1/10
0030-22	Cold Meat Fork	8-1/2"	Doz	1/10
0030-23	Solid Spoon	11-1/2"	Doz	1/10
0030-24	Banquet Slotted Spoon	11-1/2"	Doz	1/10
0030-25	Banquet Fork	12"	Doz	1/10

Coordinate with Shangarila flatware, #0030-Series

STAINLESS STEEL BUFFET SERVICE



ELEGANCE STAINLESS STEEL SERVING PIECES

◆ Heavyweight, mirror-finish

ITEM	DESCRIPTION	LENGTH	UOM	CASE
LE-1	Gravy & Soup Ladle, 1 Oz	7"	Doz	1/36
LE-2	Gravy & Soup Ladle, 2 Oz	9"	Each	12/120
LE-4	Gravy & Soup Ladle, 4 Oz	13"	Each	12/120
LE-11	Solid Spoon	11"	Each	12/120
LE-13	Solid Spoon	13"	Each	12/120
LE-20	Fork	13"	Each	12/120

Coordinate with Elegance flatware, #0024 and #0004-Series



18/8 STAINLESS STEEL SERVING TONGS

- ◆ Heavyweight, satin-finish
- ◆ Dishwasher safe

ITEM	DESCRIPTION	SIZE	UOM	CASE
STH-8	Short	8-1/2"	Each	12/72
STH-10	Medium	10-1/2"	Each	12/72
STH-13	Long	13-1/2"	Each	12/72



Turn the page for more varieties of tongs.

STAINLESS STEEL SPAGHETTI TONGS

ITEM	DESCRIPTION	SIZE	UOM	CASE
ST-8	Mirror Finish	8"	Each	12/240



**STAINLESS STEEL
BUFFET SERVICE**



PTOS-8



ST-2



ST-10S



ST-10



ST-105SF

STAINLESS STEEL SALAD TONGS

ITEM	DESCRIPTION	SIZE	UOM	CASE
PTOS-8	Oval Salad Tong, Satin Finish	7-3/4"	Each	12/96
ST-2	Double Spoon, Mirror Finish	10"	Each	6/60
ST-10	Fork and Spoon, Satin Finish	10"	Each	6/60
ST-10S	Slotted and Solid Spatula, Mirror Finish	10"	Each	12/96
ST-105SF	Spatula and Fork, Mirror Finish	10-1/2"	Each	12/96

STAINLESS STEEL PASTRY TONGS

ITEM	DESCRIPTION	SIZE	UOM	CASE
PT-8	Solid with Short Handle	7-1/2"	Each	12/120
PT-875	Solid with Long Handle	8-3/4"	Each	12/144
PT-10P	Perforated Scissor Style	10-1/2"	Each	12/96



PT-8



PT-875



PT-10P



ICT-7



ICT-7 Texture



IT-7

STAINLESS STEEL ICE TONGS

ITEM	DESCRIPTION	SIZE	UOM	CASE
ICT-7	Five Prong, Textured	7"	Each	12/144
IT-7	Three Prong, Satin Finish	7"	Each	12/120

STAINLESS STEEL POM TONGS

ITEM	DESCRIPTION	SIZE	UOM	CASE
PT-6	Satin Finish	6"	Doz	4/24
PT-9	Satin Finish	9"	Doz	4/24



PT-6

PT-9

Save money - the edges of CURV™ utensils get into tight corners and eliminate waste.

- ◆ No dripping with contoured pouring spouts
- ◆ Molded-in stopper on spoon handle prevents slipping into pan/pot
- ◆ Textured exterior finish provides a secure grip
- ◆ Easy-clean smooth, high-gloss interior finish

POLYCARBONATE SERVING UTENSILS



CURV™ ONE-PIECE DUAL SPOUT LADLES

ITEM	DESCRIPTION	SIZE	UOM	CASE
CVLD-8C	Clear 3/4 oz	8-1/2"	Each	12/144
CVLD-8K	Black 3/4 oz	8-1/2"	Each	12/144
CVLD-8R	Red 3/4 oz	8-1/2"	Each	12/144
CVLD-13C	Clear 1 oz	13"	Each	12/144
CVLD-13K	Black 1 oz	13"	Each	12/144
CVLD-13R	Red 1 oz	13"	Each	12/144

CURV™ DUAL SPOUT SERVING SPOONS

- ◆ 1-1/2 oz capacity

ITEM	DESCRIPTION	SIZE	UOM	CASE
CVSS-13C	Clear Solid	13"	Each	12/144
CVSS-13K	Black Solid	13"	Each	12/144
CVSS-13R	Red Solid	13"	Each	12/144
CVSS-15C	Clear Solid	15"	Each	12/144
CVSS-15K	Black Solid	15"	Each	12/144
CVSS-15R	Red Solid	15"	Each	12/144
CVPS-13C	Clear Perforated	13"	Each	12/144
CVPS-13K	Black Perforated	13"	Each	12/144
CVPS-13R	Red Perforated	13"	Each	12/144
CVPS-15C	Clear Perforated	15"	Each	12/144
CVPS-15K	Black Perforated	15"	Each	12/144
CVPS-15R	Red Perforated	15"	Each	12/144



CURV™ TAPERED BUFFET SPOONS

- ◆ 3/4 oz capacity

ITEM	DESCRIPTION	SIZE	UOM	CASE
CVBS-10C	Clear	10"	Each	12/144
CVBS-10K	Black	10"	Each	12/144
CVBS-10R	Red	10"	Each	12/144



CURV™ SERVING TONGS

ITEM	DESCRIPTION	SIZE	UOM	CASE
CVST-6C	Clear	6"	Each	12/144
CVST-6K	Black	6"	Each	12/144
CVST-6R	Red	6"	Each	12/144
CVST-9C	Clear	9"	Each	12/144
CVST-9K	Black	9"	Each	12/144
CVST-9R	Red	9"	Each	12/144
CVST-12C	Clear	12"	Each	12/144
CVST-12K	Black	12"	Each	12/144
CVST-12R	Red	12"	Each	12/144



SPAGHETTI TONGS

- ◆ Heat-resistant up to 302°F (150°C)

ITEM	DESCRIPTION	SIZE	UOM	CASE
PPT-11B	Beige	11"	Each	24/144
PPT-11C	Clear	11"	Each	24/144



FLAT TONGS

- ◆ Textured grip

ITEM	DESCRIPTION	SIZE	UOM	CASE
PUTF-6B	Beige	6"	Each	12/432
PUTF-6C	Clear	6"	Each	12/432
PUTF-6K	Black	6"	Each	12/432





SINGLE-SERVE MINI CAST IRON COOKWARE

FIREIRON™ MINI CAST IRON COOKWARE

Artfully present single-serve portions in mini enameled cast iron cookware.

- ◆ Skillets (CAST-3 & CAST-5) include an ergonomic thumbrest for comfortable grip
- ◆ Lip under dual handles for easy handling and secure grip
- ◆ Use on multiple cooking surfaces, including induction

ITEM	DESCRIPTION	CAPACITY	UOM	CASE
CAST-3	3-1/2" Dia	3 Oz	Each	6
CAST-5	4-7/8" Dia	7 Oz	Each	6
CASM-5R	5-1/8" Dia	12 Oz	Each	6
CASM-6R	6-3/8" Dia	14 Oz	Each	6
CASM-6O	6-1/2" x 4-1/4"	9 Oz	Each	6
CASM-7O	7-3/8" x 5-3/8"	16 Oz	Each	6
CASM-4S	4-7/8" Square	10 Oz	Each	6
CASM-5RT	5-7/8" x 4-1/8"	10 Oz	Each	6
CASM-7RT	7" x 4-3/4"	14 Oz	Each	6



CAST-3
3 OZ



CAST-5
7 OZ



CASM-5R
12 OZ



CASM-6R
14 OZ



CASM-6O
9 OZ



CASM-7O
16 OZ



CASM-4S
10 OZ



CASM-5RT
10 OZ



CASM-7RT
14 OZ



Specially designed lip under the handles for a secure grip



Refer to Professional Cookware for full-size cast iron skillets



CAST-SERIES & CASM-SERIES



FIREIRON™ MINI CAST IRON WOOD UNDERLINERS

- ◆ Dual contoured handles for secure grip to safely transport hot skillets
- ◆ Protect table/countertop surfaces from heat damage
- ◆ Hand wash only

ITEM	DESCRIPTION	SHAPE	UOM	CASE
CASM-4SUL	Fits CASM-4S	Square	Each	12/48
CASM-5TUL	Fits CASM-5RT	Rectangular	Each	12/48
CASM-7TUL	Fits CASM-7RT	Rectangular	Each	12/48
CASM-6OUL	Fits CASM-6O	Oval	Each	12/48
CASM-7OUL	Fits CASM-7O	Oval	Each	12/48
CASM-6RUL	Fits CASM-6R	Round	Each	12/48
CAST-5UL	Fits CASM-5R & CAST-5	Round	Each	12/48
CAST-6UL	Fits CAST-6	Round	Each	12/48
CAST-8UL	Fits CAST-8	Round	Each	12/48



CAST-5R with CAST-5UL



CAST-4S with CASM-4SUL

MINI CAST IRON WOOD UNDERLINERS



CASM-5TUL



CASM-4SUL



CASM-7OUL



CASM-6OUL



CAST-8UL



CAST-5UL

- ◆ Tri-ply construction with either stainless steel or copper exterior, all induction ready
- ◆ Aluminum core provides efficient heat distribution
- ◆ 18/8 stainless steel cooking surface

SINGLE-SERVE MINI COOKWARE



TRI-PLY MINI COOKWARE WITH COPPER EXTERIOR

ITEM	DESCRIPTION	CAPACITY	UOM	CASE
DCCR-3C	3.75" Casserole	15 Oz	Each	1/30
DCFP-4C	4" Fry Pan	5 Oz	Each	1/30
DCSC-3C	3" Saucier	5 Oz	Each	1/30
DCSP-3C	3.5" Sauce Pan	11 Oz	Each	1/30



DCCR-3C

DCCP-3S

TRI-PLY MINI COOKWARE WITH STAINLESS STEEL EXTERIOR

ITEM	DESCRIPTION	CAPACITY	UOM	CASE
DCCR-3S	3.75" Casserole	15 Oz	Each	1/30
DCFP-4S	4" Fry Pan	5 Oz	Each	1/30
DCSC-3S	3" Saucier	5 Oz	Each	1/30
DCSP-3S	3.5" Sauce Pan	11 Oz	Each	1/30



DCFP-4S

DCFP-4C



DCSC-3S

DCSC-3C

TRI-PLY MINI COOKWARE LIDS

ITEM	DESCRIPTION	UOM	CASE
DCL-35	Lid for 3.5" DCSP, Sauce Pan	Each	1/50
DCL-375	Lid for 3.75" DCCR, Casserole	Each	1/50



DCCR-3S & DCL-375



DCSP-3S

DCSP-3C



MINI COOKWARE



DCWE-105S



DCWE-202C



DCWC-101S



DCWC-201C



DCWB-101S



DCWA-101S



DCWA-201C



DCWD-101S



STAINLESS STEEL MINI CASSEROLES

ITEM	DESCRIPTION	CAPACITY	UOM	CASE
DCWE-101S	2-3/4"Dia x 1-3/4"H	5 Oz	Each	12/36
DCWE-102S	3-1/8"Dia x 1-3/4"H	7 Oz	Each	12/36
DCWE-103S	3-1/2"Dia x 2"H	10 Oz	Each	12/36
DCWE-104S	4-1/4"Dia x 2-3/8"H	17 Oz	Each	12/36
DCWE-105S	4-3/4"Dia x 3"H	28 Oz	Each	12/36



COPPER-PLATED MINI CASSEROLES

ITEM	DESCRIPTION	CAPACITY	UOM	CASE
DCWE-202C	3-1/8"Dia x 1-3/4"H	7 Oz	Each	12/36
DCWE-203C	3-1/2"Dia x 2"H	10 Oz	Each	12/36
DCWE-204C	4-1/4"Dia x 2-3/8"H	17 Oz	Each	12/36
DCWE-205C	4-3/4"Dia x 3"H	28 Oz	Each	12/36



STAINLESS STEEL MINI FRY PANS

ITEM	DESCRIPTION	CAPACITY	UOM	CASE
DCWC-101S	4"Dia x 1-1/8"H	7 Oz	Each	12/96
DCWC-102S	4-1/2"Dia x 1-3/8"H	10 Oz	Each	12/72
DCWC-103S	5"Dia x 1-1/8"H	12 Oz	Each	12/48



COPPER-PLATED MINI FRY PAN

ITEM	DESCRIPTION	CAPACITY	UOM	CASE
DCWC-201C	5-1/2"Dia x 1-3/8"H	11 Oz	Each	12/48



STAINLESS STEEL MINI TAPERED SAUCE PANS

ITEM	DESCRIPTION	CAPACITY	UOM	CASE
DCWB-101S	2-3/4"Dia x 1-3/4"H	4 Oz	Each	12/72
DCWB-102S	3-3/8"Dia x 2-3/8"H	9 Oz	Each	12/72
DCWB-103S	4"Dia x 2-3/8"H	12 Oz	Each	12/48



STAINLESS STEEL MINI SAUCE PANS

ITEM	DESCRIPTION	CAPACITY	UOM	CASE
DCWA-101S	2"Dia x 1-3/16"H	2 Oz	Each	12/120
DCWA-102S	2-3/4"Dia x 1-3/4"H	5 Oz	Each	12/120
DCWA-103S	3-1/8"Dia x 1-3/4"H	7 Oz	Each	12/96
DCWA-104S	3-1/2"Dia x 2"H	10 Oz	Each	12/48
DCWA-105S	4-3/8"Dia x 2-3/8"H	18 Oz	Each	12/48
DCWA-106S	5"Dia x 3"H	28 Oz	Each	12/48



COPPER-PLATED MINI SAUCE PANS

ITEM	DESCRIPTION	CAPACITY	UOM	CASE
DCWA-201C	2"Dia x 1-3/16"H	2 Oz	Each	12/120
DCWA-202C	2-3/4"Dia x 1-3/4"H	5 Oz	Each	12/120
DCWA-203C	3-1/8"Dia x 1-3/4"H	7 Oz	Each	12/96
DCWA-204C	3-1/2"Dia x 2"H	10 Oz	Each	12/48
DCWA-205C	4-3/8"Dia x 2-3/8"H	18 Oz	Each	12/48
DCWA-206C	5"Dia x 3"H	28 Oz	Each	12/48



STAINLESS STEEL MINI WOKS

ITEM	DESCRIPTION	CAPACITY	UOM	CASE
DCWD-101S	3-3/8"Dia x 1"H	3 Oz	Each	12/96
DCWD-102S	4"Dia x 1-3/16"H	5 Oz	Each	12/96

STAINLESS STEEL MINI COLANDERS

ITEM	DESCRIPTION	CAPACITY	UOM	CASE
DDSC-101S	3-3/4"Dia	2 Oz	Each	12/120
DDSC-102S	4"Dia	4 Oz	Each	12/120
DDSC-103S	5-1/8"Dia	9 Oz	Each	12/72

MINI COLANDERS



DDSC-101S

STAINLESS STEEL MINI ROASTING PANS

ITEM	DESCRIPTION	CAPACITY	UOM	CASE
DDSB-101S	4-1/2" Sq	13 Oz	Each	12/72
DDSB-102S	5-3/16" Sq	24 Oz	Each	12/48
DDSB-103S	5"L x 3-3/8"W	11 Oz	Each	12/72
DDSB-104S	5-3/4"L x 3-3/4"W	16 Oz	Each	12/72

MINI ROASTING PANS



DDSB-101S

DDSB-203C

COPPER-PLATED MINI ROASTING PANS

ITEM	DESCRIPTION	CAPACITY	UOM	CASE
DDSB-201C	4-1/2" Sq	13 Oz	Each	12/72
DDSB-202C	5-3/16" Sq	24 Oz	Each	12/48
DDSB-203C	5"L x 3-3/8"W	11 Oz	Each	12/72
DDSB-204C	5-3/4"L x 3-3/4"W	16 Oz	Each	12/72

STAINLESS STEEL KADY BOWLS

Elegantly serve saucy dishes in attractive mirror-finish kady bowls.

- ◆ Welded handles for durability; easily transport hot dishes
- ◆ Great for serving, displays and more

KADY BOWLS



KDB-7

ITEM	DESCRIPTION	CAPACITY	UOM	CASE
KDB-5	5"Dia	20 Oz	Each	6/96
KDB-6	6"Dia	28 Oz	Each	6/72
KDB-7	7"Dia	40 Oz	Each	6/48

CARBON STEEL COOK & SERVEWARE

Spanish-made, blini pans are ideal for adding a rustic look to fresh-cooked eggs or displaying individual Mediterranean dishes.

- ◆ Hand wash, dry thoroughly and store in dry area
- ◆ Made in Spain
- ◆ Non-stick for easy release (CSPP-4E)

MINI COOKWARE



4-3/4" diameter individual serving size



CSPP-4



CSPP-4E



FRY CUPS



SFC-35



SFC-35H



STAINLESS STEEL FRY CUPS

Perfect for serving fries, calamari, onion rings and other small-portion finger foods!

- ◆ Satin-finish
- ◆ 3-1/4" diameter x 3-1/2" high

ITEM	DESCRIPTION	UOM	CASE
SFC-35	Smooth Exterior	Each	12/120
SFC-35H	Hammered Exterior	Each	12/120



STAINLESS STEEL FRY CUP WITH WIRE BASKET

ITEM	DESCRIPTION	UOM	CASE
SFCW-4S	4"Dia	Set	12/48



SFCW-4S



WBKH-5



BLACK WIRE CONE FRY SERVER

ITEM	DESCRIPTION	UOM	CASE
WBKH-5	1-Cone, Holds 2 Oz Ramekins	Each	12

MINI SERVING BASKETS



FBM-544T



FBM-554S



FBM-32R



1 1/8" STAINLESS STEEL MINI SERVING BASKETS

Single-serve solution for side dishes or appetizers.

- ◆ Dishwasher safe

ITEM	DESCRIPTION	UOM	CASE
FBM-32R	Round, 3-3/4"Dia x 2-7/8"H	Each	12/72
FBM-443S	Square, 4"L x 4"W x 3"H	Each	12/72
FBM-554S	Square, 5"L x 5"W x 3"H	Each	12/72
FBM-433T	Rectangular, 4"L x 3"W x 3"H	Each	12/72
FBM-544T	Rectangular, 5"L x 4"W x 4"H	Each	12/72

TACO SERVICE

NSF

BPA FREE



PTS-4



TCHS-23MN



4-SLOT TACO SERVER

- ◆ 2 pieces per pack

ITEM	DESCRIPTION	UOM	CASE
PTS-4	8"L x 5"W x 2-1/2"H	Set	1/16



STAINLESS STEEL MINI TACO HOLDERS

- ◆ Brushed finish; 2"W x 1"H

ITEM	DESCRIPTION	UOM	CASE
TCHS-12MN	1-2 Slots, 2-3/8"L	Each	12/96
TCHS-23MN	2-3 Slots, 3-1/2"L	Each	12/72



STAINLESS STEEL TACO HOLDERS

- ◆ Also useful for dressing hot dogs
- ◆ Can flip over to accommodate different quantities
- ◆ Brushed finish; 4"W x 2"H

ITEM	DESCRIPTION	UOM	CASE
TCHS-12	1-2 Slots, 5-5/8"L	Each	12/96
TCHS-23	2-3 Slots, 8-3/8"L	Each	12/72
TCHS-34	3-4 Slots, 11-3/8"L	Each	12/48
TCHS-45	4-5 Slots, 14"L	Each	12/36



TCHS-12



TCHS-34



TCHS-23



TCHS-45

COPPER-PLATED MOSCOW MULE MUGS

- ◆ Traditional mug for serving the Moscow Mule drink for optimal taste, temperature, and presentation
- ◆ Maintains a cool temperature for cold, frosty drinks
- ◆ Wide handle for minimal hand-to-mug contact
- ◆ Corrosion resistant copper-plating, lead-free brass handles

ITEM	DESCRIPTION	CAPACITY	UOM	CASE
CMM-20	Smooth	20 Oz	Each	36
CMM-20H	Hammered	20 Oz	Each	36

MOSCOW MULE MUGS



CMM-20

CMM-20H

STAINLESS STEEL MINT JULEP CUPS

- ◆ Traditional cup for crafting the iconic Mint Julep in keeps drinks icy cold while sipping

ITEM	DESCRIPTION	CAPACITY	UOM	CASE
DDSE-101S	3"Dia x 4-3/8"H	11 Oz	Each	12/72
DDSE-102S	3-3/8"Dia x 4-3/4"H	14 Oz	Each	12/72

MINT JULEP CUPS



DDSE-102S

DDSE-101S

STAINLESS STEEL MINI MILK CANS

Attractive and functional, mini milk cans elevate individual servings of sauce, dressing or creamer.

ITEM	DESCRIPTION	CAPACITY	UOM	CASE
DDSD-101S	2"Dia x 2"H	3 Oz	Each	12/144
DDSD-102S	2"Dia x 3-1/8"H	5 Oz	Each	12/72
DDSD-103S	3-1/8"Dia x 4"H	14 Oz	Each	12/36
DDSD-104S	3-1/8"Dia x 5"H	20 Oz	Each	12/36

MINI MILK CANS & PAILS



DDSD-104S

DDSD-103S

DDSD-102S

DDSD-101S

STAINLESS STEEL HAMMERED MINI SERVING PAILS

ITEM	DESCRIPTION	CAPACITY	UOM	CASE
DDSA-101S	3"Dia x 3-1/8"H	5 Oz	Each	12/72
DDSA-102S	3-1/2"Dia x 3-5/8"H	10 Oz	Each	12/72
DDSA-103S	5"Dia x 5"H	28 Oz	Each	12/48



DDSA-103S

DDSA-101S

STAINLESS STEEL SMOOTH MINI SERVING PAILS

ITEM	DESCRIPTION	CAPACITY	UOM	CASE
DDSA-104S	3"Dia x 3-1/8"H	5 Oz	Each	12/72
DDSA-105S	3-1/2"Dia x 3-5/8"H	10 Oz	Each	12/72
DDSA-106S	3-3/4"Dia x 3-3/4"H	12 Oz	Each	12/72
DDSA-107S	5"Dia x 5"H	28 Oz	Each	12/48



DDSA-107S

DDSA-105S

SERVING TRAYS



DDSH-102S



STAINLESS STEEL MINI SERVING PLATTERS

ITEM	DESCRIPTION	UOM	CASE
DDSH-101S	6-5/8"L x 4-1/4"W	Each	12/72
DDSH-102S	8-1/2"L x 5-1/4"W	Each	12/72



DDSI-101S



DDSI-102S



STAINLESS STEEL LONG SERVING TRAYS

ITEM	DESCRIPTION	UOM	CASE
DDSI-101S	14-1/8"L x 3-1/2"W	Each	12/48
DDSI-102S	14-1/8"L x 7-1/2"W	Each	12/24

WOODEN FRENCH BREAD BOARD



BIRCH WOOD FRENCH BREAD BOARD

◆ Hand wash only, do not soak or submerge

ITEM	DESCRIPTION	UOM	CASE
WCB-225	22-1/2"L x 5-1/2"W x 3/4"H	Each	12



WCB-225



SERVING BOARDS



ACACIA WOOD & MARBLE SERVING BOARDS

◆ Hand wash only, do not soak or submerge

ITEM	DESCRIPTION	UOM	CASE
SBMW-117	11-1/8"L Overall	Each	6
SBMW-156	15-1/2"L Overall	Each	6
SBMW-157	14-3/4"L Overall	Each	6

SBMW-117
8-7/8" X 7-1/4",
2-1/4" HANDLE



SBMW-156
11-1/4" X 6",
4-1/4" HANDLE



SBMW-157
10-1/2" X 7-1/4",
4-1/4" HANDLE



MAESTRO PEPPER MILLS

- ◆ Premium quality beechwood
- ◆ Durable carbon steel grinder for clean, sharp cuts
- ◆ Long-lasting internal stainless steel mechanisms

ITEM	DESCRIPTION	UOM	CASE
WPM-6CD	6"H Espresso Pepper Mill	Each	1/48
WPM-8CD	8"H Espresso Pepper Mill	Each	1/36
WPM-10CD	10"H Espresso Pepper Mill	Each	1/24
WPM-12CD	12"H Espresso Pepper Mill	Each	1/24



Tighten or loosen knob on top to adjust for fine or coarse grind



Easily disassemble for refilling

SALT & PEPPER MILLS



WPM-6CD WPM-8CD WPM-10CD WPM-12CD



WPM-6K WPM-8K

MAESTRO REPLACEMENT KNOBS

ITEM	DESCRIPTION	UOM	CASE
WPM-6K	Knob for 6" Pepper Mills	Each	1/48
WPM-8K	Knob for 8" Pepper Mills	Each	1/48

WOODEN PEPPER MILLS

- ◆ Rubberwood with zinc alloy grinder
- ◆ Rich russet brown tone
- ◆ Easily disassemble for refilling

ITEM	DESCRIPTION	UOM	CASE
WPM-08	8"H Brown Pepper Mill	Each	1/36
WPM-10	10"H Brown Pepper Mill	Each	1/24
WPM-12	12"H Brown Pepper Mill	Each	1/24
WPM-18	18"H Brown Pepper Mill	Each	1/12

Stylish pepper / spice service



WPM-08 WPM-10 WPM-12 WPM-18

BLACK WOODEN SALT & PEPPER MILL SETS

- ◆ Rubberwood black matte finish
- ◆ Easily disassemble for refilling
- ◆ 2-1/4" Dia x 6" High

ITEM	DESCRIPTION	UOM	CASE
SP-612	Black Salt & Pepper, 2-Pcs/Set	Set	1/24
SP-624	Black Pepper Mills, 2-Pcs/Set	Set	1/24



SP-612
SALT & PEPPER

SP-624
2 PEPPERMILLS

ACRYLIC SALT / PEPPER MILL

- ◆ Clear view of contents to manage inventory
- ◆ Easily disassemble for refilling
- ◆ Stands 6" tall

ITEM	DESCRIPTION	UOM	CASE
WPMP-6	Clear Salt or Pepper Mill	Each	1/72



WPMP-6

PLATTER SERVERS



CAST IRON FAJITA/STEAK SERVERS

- ◆ Wood underliner resists splitting, chipping or cracking
- ◆ Cast iron servers are oven safe

ITEM	DESCRIPTION	UOM	CASE
FS-2	Fajita Server (5-3/16"L Built-in Handle) & Wood Underliner, 2-Pc Set	Set	1/12
FS-2-UL	Replacement Wood Underliner for FS-2 (No Retail Pkg)	Each	12
ISP-3	Steak Platter with 5-1/4"L Gripper Handle & Wood Underliner, 3-Pc Set	Set	1/12
ISP-3-UL	Replacement Wood Underliner for ISP-3 (No Retail Pkg)	Each	12

ALUMINUM SIZZLING PLATTERS

- ◆ Platters are oven safe
- ◆ Wood underliner resists cracking
- ◆ Platters and underliners sold separately



ITEM	DESCRIPTION	UOM	CASE
APL-10	10" Platter	Each	12/48
APL-10UL	Wood Underliner for APL-10	Each	12
APL-11	11" Platter	Each	12/48
APL-11UL	Wood Underliner for APL-11	Each	12
APL-12	12" Platter	Each	12/36
APL-12UL	Wood Underliner for APL-12	Each	12

STAINLESS STEEL SIZZLING PLATTERS

- ◆ Platters are oven safe
- ◆ Platters and underliners sold separately, and as sets



ITEM	DESCRIPTION	UOM	CASE
SIZ-11ST	11" Platter & Underliner Set	Set	12
SIZ-11	11" Oval Platter, S/S	Each	12/60
SWU-11	Underliner for SIZ-11	Each	12/36
SIZ-11BST	11" x 7" Platter & Underliner Set	Set	12
SIZ-11B	11" x 7" Rectangular Platter, S/S	Each	12/60
SWU-11B	Underliner for SIZ-11B	Each	12/36

OVAL PLATTERS



STAINLESS STEEL OVAL PLATTERS

ITEM	DESCRIPTION	UOM	CASE
OPL-12	12" x 8-5/8"	Each	10/60
OPL-14	14" x 8-3/4"	Each	10/60
OPL-16	16" x 10-1/4"	Each	10/40
OPL-18	18" x 11-1/2"	Each	10/30
OPL-20	20" x 13-3/4"	Each	10/20
OPL-22	21-3/4" x 14-1/2"	Each	12

AU GRATIN DISHES



STAINLESS STEEL AU GRATIN DISHES

ITEM	DESCRIPTION	UOM	CASE
ADO-8	8 Oz	Each	12/120
ADO-12	12 Oz	Each	12/144
ADO-15	15 Oz	Each	12/120
ADO-20	20 Oz	Each	12/72

TORTILLA PRESSES

- ◆ Traditional press with excellent leverage
- ◆ Integrated handle allows for easy open and removal of corn/flour tortillas
- ◆ Great for making burritos, enchiladas and quesadillas

ITEM	DESCRIPTION	WEIGHT	UOM	CASE
TPC-8A	8"Dia, Aluminum, Non-Stick	1.52Lbs	Each	6/12
TPC-8C	8"Dia, Cast Iron	7.94Lbs	Each	1/4



TORTILLA SERVICE



TORTILLA WARMERS

- ◆ Lid features an easy-grip recessed handle and interlocks with base to seal in heat
- ◆ Stackable to transport several at once, or compact organized storage until ready to use

ITEM	DESCRIPTION	CAPACITY	UOM	CASE
PTW-7K	7-1/2" Dia x 1-7/8"H	8 Tortillas	Each	12
PTW-8	8-1/2" Dia x 2-5/8"H	16 Tortillas	Each	12



Enhance South-of-the-Border dishes.

SALSA & DIP SERVICE

MOLCAJETE SALSA BOWLS

- ◆ Break-resistant polypropylene
- ◆ Dishwasher safe

ITEM	DESCRIPTION	UOM	CASE
PMSB-4	4 Oz, 4-Pcs/Pk	Pack	24
PMSB-10	10 Oz, 4-Pcs/Pk	Pack	12
PMSB-56	56 Oz	Each	1/16



MOLCAJETE SALSA PLATE

ITEM	DESCRIPTION	UOM	CASE
PMP-12	12 Oz, 2-Pcs/Pk	Set	1/16



CONDIMENT HOLDERS



BLACK WIRE CADDIES

ITEM	DESCRIPTION	UOM	CASE
WH-3K	Rectangle, Fits 6 Oz Cruets	Each	12/48
WBKH-6SB	Flat Back, 8-1/4" x 6 1/4" x 9"H	Each	12
WBKH-6R	Round, 6-1/4"Dia x 9"H	Each	24
WBKH-7R	Round, 7-1/2"Dia x 9"H	Each	12



WH-3K
Use caddy with G-104 cruets



WBKH-6SB



WBKH-6R



WBKH-7R

CHROME-PLATED WIRE HOLDERS



ITEM	DESCRIPTION	UOM	CASE
G-104S	Two 6 Oz Square Bottle Set w/Lids & Chrome-Plated Rack	Set	12
WH-1	Salt/Pepper Shakers & Sugar Packet Holder Rack (No Retail Pkg)	Each	12/48
WH-2	Sugar Packet Rack	Each	12/48
WH-3	Chrome-Plated Rack Holds 6 Oz Cruets (No Retail Pkg)	Each	12/48
WH-4	3-Ring Condiment Jar Rack	Each	12/48
WH-5	Rack Holds Two 6 Oz Sq Cruets	Each	12/72
WH-7	Salt/Pepper Shakers & Sugar Packets Rack	Each	12/72
WH-9	4-Ring Condiment Jar Rack	Each	12/48



WH-1
Use holder with PPH-Series packet holders, and G-110 / G-111 shakers



WH-2
Fits standard sweetener packets



WH-9
Use holder with CJ-Series condiment jars



WH-4
Use holder with CJ-Series condiment jars



G-104S



WH-3
Use rack with G-104 cruets



WH-5
Use rack with G-104 cruets



WH-7
Use rack with G-109 shakers

OIL & VINEGAR CRUETS



ITEM	DESCRIPTION	UOM	CASE
GOB-8S	2 Square 8 Oz Oil Bottles w/Lid & Chrome-Plated Rack	Set	12
GOB-16S	2 Square 16 Oz Oil Bottles w/Lid & Chrome-Plated Rack	Set	12
GOB-8	Square 8 Oz Oil Bottle w/Lid	Each	24
GOB-16	Square 16 Oz Oil Bottle w/Lid	Each	12
WH-8	Chrome Plated Rack, Fits GOB-8	Each	48



GOB-16S



GOB-8



GOB-16

GLASS SHAKERS



G-117

G-116

G-115

G-104

G-103

G-102

G-111

G-110

G-118

G-109

G-106















G-105

G-101

G-100

G-108

G-107

DESCRIPTION	SIZE	UOM	WHOLESALE BOX PACKAGING		REPLACEMENT TOPS FOR SHAKERS				
			ITEM	CASE	ITEM	DESCRIPTION	CASE		
Square Shakers, S/S Tops	1/2 Oz	Doz	G-100	1/48	G-100C	For G-100 / G-110	24/144		
Square Shakers, Brass Tops	1/2 Oz	Doz	G-101	1/48	G-101C	For G-101 / G-111	24/144		
Sugar Pourers, Flap Tops	12 Oz	Doz	G-102	1/4	G-102C	For G-102	4/48		
Cheese/Spice Shakers, Perf Tops	12 Oz	Doz	G-103	1/4	G-103C	For G-103	4/48		
Oil/Vinegar Cruets	6 Oz	Doz	G-104	1/6	G-104C	For G-104	18/108		
Paneled Shakers, Mushroom Tops	1 Oz	Doz	G-105	1/10	G-105C	For G-105	24/120		
Paneled Shakers, Mushroom Tops	2 Oz	Doz	G-106	1/10	G-106C	For G-106	24/120		
Cheese Shakers, Perf Tops	6 Oz	Doz	G-107	1/5	G-107C	For G-107	5/90		
Cheese Shakers, Slotted Tops	6 Oz	Doz	G-108	1/5	G-108C	For G-108	5/90		
Square Shakers, S/S Mushroom Tops	2 Oz	Doz	G-109	1/12	G-109C	For G-109	12/96		
Tower Shakers, S/S Tops	1 Oz	Doz	G-110	1/12					G-104C
Tower Shakers, Brass Tops	1 Oz	Doz	G-111	1/12					
Paneled Shakers, Mushroom Tops	3 Oz	Doz	G-117	1/12					
Classic Shakers, S/S Flat Tops	2 Oz	Doz	G-118	1/12					
Syrup Dispensers	6 Oz	Doz	G-115	1/6					
Syrup Dispensers	14 Oz	Doz	G-116	1/4					
									

SALT & PEPPER REFILLER JUGS

◆ Spring loaded spout allows for quick refills

ITEM	DESCRIPTION	UOM	CASE
PR-05P	1/2 Gal Pepper Refiller	Each	24
PR-05S	1/2 Gal Salt Refiller	Each	24

SALT & PEPPER REFILLERS



PR-05S

PR-05P

CONDIMENT DISPENSER



PKTS-2D

BPA FREE

PKTS-SERIES

CONDIMENT DISPENSER

- ◆ Durable 18/8 stainless steel, heavy duty pump
- ◆ Two (2) 3-1/2 Qt plastic fountain jars included (7 Qt total)
- ◆ Each pump dispenses between 1 oz and 1-1/4 oz portions, depending on thickness of condiments
- ◆ Overall dimensions: 11"L x 8-3/4"W x 16"H (with pump)
- ◆ Assembly required

ITEM	DESCRIPTION	UOM	CASE
PKTS-2D	Condiment Dispenser with 2 Standard Pumps	Set	1
PKTS-PT01	Individual Pump with Lid	Each	20
PKTS-PT02	Replacement Plastic Fountain Jar	Each	6
PKTS-PT03	Stainless Steel Casing	Each	1

SAUCE & DESSERT CUPS



RFM-SERIES



Fluted Ramekins



RP-SERIES



Plain Ramekins



BLACK

WHITE

BONE

NSF

BPA FREE

MELAMINE RAMEKINS

MELAMINE RAMEKINS

- ◆ Fluted or plain

ITEM	DESCRIPTION	CAPACITY	COLOR	UOM	CASE
RFM-1K	Fluted	1-1/2 Oz	Black	Doz	1/8
RFM-1W	Fluted	1-1/2 Oz	White	Doz	1/8
RFM-1B	Fluted	1-1/2 Oz	Bone	Doz	1/8
RFM-2K	Fluted	2 Oz	Black	Doz	1/8
RFM-2W	Fluted	2 Oz	White	Doz	1/8
RFM-2B	Fluted	2 Oz	Bone	Doz	1/8
RFM-3K	Fluted	3 Oz	Black	Doz	1/8
RFM-3W	Fluted	3 Oz	White	Doz	1/8
RFM-3B	Fluted	3 Oz	Bone	Doz	1/8
RFM-4K	Fluted	4 Oz	Black	Doz	1/8
RFM-4W	Fluted	4 Oz	White	Doz	1/8
RFM-4B	Fluted	4 Oz	Bone	Doz	1/8
RP-1K	Plain	1-1/2 Oz	Black	Doz	1/8
RP-1W	Plain	1-1/2 Oz	White	Doz	1/8
RP-1B	Plain	1-1/2 Oz	Bone	Doz	1/8
RP-2K	Plain	2 Oz	Black	Doz	1/8
RP-2W	Plain	2 Oz	White	Doz	1/8
RP-2B	Plain	2 Oz	Bone	Doz	1/8
RP-3K	Plain	3 Oz	Black	Doz	1/8
RP-3W	Plain	3 Oz	White	Doz	1/8
RP-3B	Plain	3 Oz	Bone	Doz	1/8
RP-4K	Plain	4 Oz	Black	Doz	1/8
RP-4W	Plain	4 Oz	White	Doz	1/8
RP-4B	Plain	4 Oz	Bone	Doz	1/8
RP-6K	Plain	6 Oz	Black	Doz	1/8
RP-6W	Plain	6 Oz	White	Doz	1/8
RP-6B	Plain	6 Oz	Bone	Doz	1/8

STAINLESS STEEL SAUCE CUPS



SCP-15

SCP-25

SCP-40

ITEM	DESCRIPTION	UOM	CASE
SCP-15	1-1/2 Oz	Doz	1/48
SCP-25	2-1/2 Oz	Doz	1/48
SCP-40	4 Oz	Doz	1/48

SAN-PLASTIC SYRUP / CREAM PITCHER

NSF

BPA FREE

PSN-2



ITEM	DESCRIPTION	UOM	CASE
PSN-2	2 Oz Pitcher, 24-Pcs/Pk	Pack	6/12

BPA FREE

ICC-5C



SAN-PLASTIC TULIP-RIM COLD DESSERT DISH

ITEM	DESCRIPTION	UOM	CASE
ICC-5C	5 Oz Dish	Doz	1/16

STAINLESS STEEL GRAVY BOATS

ITEM	DESCRIPTION	UOM	CASE
GBS-3	3 Oz	Each	12/72
GBS-5	5 Oz	Each	12/48
GBS-8	8 Oz	Each	12/36
GBS-10	10 Oz	Each	12/36



GBS-10

STAINLESS STEEL SERVERS / CREAMERS

ITEM	DESCRIPTION	UOM	CASE
SCT-10	10 Oz w/Knob	Each	12/120
SCT-10F	10 Oz, Stackable Cover	Each	12/120



SCT-10F



SCT-10

STAINLESS STEEL TAPERED SPOUT BELL CREAMERS

- ◆ Smooth mirror finish for a sleek tabletop presentation
- ◆ Ideal for creamer, syrup, sauces and more

ITEM	DESCRIPTION	UOM	CASE
BCS-3	3 Oz	Each	12/144
BCS-5	5 Oz	Each	12/144
BCS-8	8 Oz	Each	12/144
BCS-10	10 Oz	Each	12/72



3 oz / 1-2 servings



BCS-3



BCS-8

SYRUP DISPENSERS & COLOR LIDS

- ◆ Stainless steel slide opening pours without dripping
- ◆ PE bottles and interchangeable PP Lids

ITEM	DESCRIPTION	UOM	CASE
PSUD-32	32 Oz	Each	12
PSUD-48	48 Oz	Each	12
PSUD-RLid	Lid, Red	Each	24/144
PSUD-TLid	Lid, Tan	Each	24/144
PSUD-WLid	Lid, White	Each	24/144



PSUD-TLID



PSUD-RLID



PSUD-48



PSUD-32



STAINLESS STEEL SWEETENER PACKET HOLDERS

ITEM	DESCRIPTION	UOM	CASE
DDSG-101S	3-3/16"L x 2-5/8"W Tray	Each	12/144
DDSG-102S	1-3/4" Square Cup	Each	12/144
DDSG-103S	2"Dia Round Cup	Each	12/216
DDSG-301S	2"Dia Rnd & 2" Square Sugar Packet Holder Set	Each	12/60



DDSG-301S

PLASTIC SWEETENER PACKET HOLDERS

- ◆ 3-1/2" L x 2-1/2" W x 2" H

ITEM	DESCRIPTION	UOM	CASE
PPH-1C	Clear	Doz	1/6
PPH-1K	Black	Doz	1/6
PPH-1W	White	Doz	1/6



PPH-SERIES



CONDIMENT SERVICE



SBR-30



T-710



STAINLESS STEEL ROLL-TOP FOOTED SUGAR BOWL

ITEM	DESCRIPTION	UOM	CASE
SBR-30	20 Oz	Each	1/24

STAINLESS STEEL HINGED LID SUGAR CAN

- ◆ Slotted, hinged lid

ITEM	DESCRIPTION	UOM	CASE
T-710	10 Oz	Each	1/72



SD-5



SBW-35

STAINLESS STEEL SHERBET FOOTED DISHES

- ◆ Paneled design with footed base

ITEM	DESCRIPTION	UOM	CASE
SD-3	3-1/2 Oz	Each	12/120
SD-5	5 Oz	Each	12/120

BUTTER WARMER

- ◆ Set includes wire stand, stainless steel butter pan, glass votive holder and candle

ITEM	DESCRIPTION	UOM	CASE
SBW-35	4-Pc Set	Set	1/48



CJ-2C



CJ-PC



CJ-7P



CJ-7G

CONDIMENT JARS & COVERS

- ◆ 7 oz capacity jars
- ◆ Covers can be used with either jar

ITEM	DESCRIPTION	UOM	CASE
CJ-7P	Clear Jar, Plastic	Doz	1/6
CJ-7G	Clear Jar, Glass	Doz	3
CJ-PC	Slotted Cover, Plastic	Doz	24
CJ-2C	Slotted Cover, S/S	Each	36/144



RS-4

STAINLESS STEEL RELISH SERVERS

- ◆ 8 oz capacity per cup

ITEM	DESCRIPTION	UOM	CASE
RS-3	3 Compartments	Set	1/24
RS-4	4 Compartments	Set	1/24



SNAIL SERVICE



SND-6

STAINLESS STEEL SNAIL SERVICE

- ◆ Neatly serve escargot

ITEM	DESCRIPTION	UOM	CASE
SND-6	Dish, 6 Wells	Each	12/144
SND-T6	Tongs	Each	12/120
SND-F7	Fork	Doz	1/50



SND-T6



SND-F7

ALUMINUM SEAFOOD TRAYS

Create an enticing display of shrimp, seafood or tasty appetizers with assorted size trays.

- ◆ Aluminum retains cold to keep food at safe serving temperatures
- ◆ Brushed finish disguises scratches for optimal presentation

ITEM	DESCRIPTION	UOM	CASE
ASFT-12	12"Dia x 1-1/2"H	Each	12/36
ASFT-14	13-3/4"Dia x 1-1/2"H	Each	12/36
ASFT-16	15-3/4"Dia x 1-1/2"H	Each	12/24
ASFT-18	17-3/4"Dia x 1-1/2"H	Each	12/24
ASFT-20	19-3/4"Dia x 1-1/2"H	Each	12

SEAFOOD TRAYS



ASFT-12



CHROME-PLATED SEAFOOD TRAY DISPLAY RACKS

- ◆ Compatible with ASFT-series trays; also ideal for elevating pizza pans for tabletop presentation

ITEM	DESCRIPTION	UOM	CASE
SFR-4	7-3/8" Top Dia, 9-5/8" Bottom Dia x 4-3/8"H	Each	20
SFR-7	7-3/8" Top Dia, 9-5/8" Bottom Dia x 7"H	Each	20

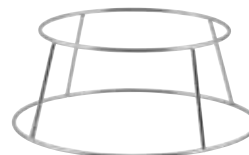

SFR-4

PEARLIZED LIGHTWEIGHT ABS-PLASTIC SHELL BOWLS

ITEM	DESCRIPTION	UOM	CASE
PSBW-1W	20 Oz Bowl	Each	12/48
PSBW-5W	5 Qt Bowl	Each	6/12

SALAD BOWLS



PSBW-1W



PSBW-5W

PEBBLED POLYCARBONATE SALAD BOWLS

ITEM	DESCRIPTION	UOM	CASE
PBB-6	6-3/4" Bowl	Each	96
PBB-8	8-3/4" Bowl	Each	48
PBB-10	10-3/4" Bowl	Each	24
PBB-12	12-3/4" Bowl	Each	24
PBB-15	15-3/4" Bowl	Each	12
PBB-18	18-3/4" Bowl	Each	12



PBB-10

PBB-SERIES



WOODEN SALAD BOWLS

- ◆ Hand wash only

ITEM	DESCRIPTION	UOM	CASE
WWB-5	5" Bowl	Each	12/288
WWB-6	6" Bowl	Each	12/288
WWB-8	8" Bowl	Each	12/144
WWB-10	10" Bowl	Each	12/96
WWB-12	12" Bowl	Each	12/72
WWB-14	14" Bowl	Each	12/36
WWB-16	16" Bowl	Each	12/24
WWB-18	18" Bowl	Each	12
WWB-20	20" Bowl	Each	12



WWB-SERIES



BLACK WIRE SERVING BASKETS

ITEM	DESCRIPTION	SIZE	UOM	CASE
WBKG-9	Rectangular	9" x 5-7/8" x 3"	Each	24
WBKG-8R	Round	8" Dia	Each	48
WBKG-10O	Oval	10" x 6-1/2" x 3"	Each	24
WBKG-10R	Round	10" Dia	Each	12
WBKG-15	Long Oval	15" x 6-1/4" x 3"	Each	12

BLACK WIRE BASKETS



WBKG-10O



WBKG-9



WBKG-15



WBKG-10R



TABLETOP BASKETS



PWBN-9B

PWBN-9R

PWBN-9V

TAN WOVEN POLY BASKETS

ITEM	DESCRIPTION	SIZE	UOM	CASE
PWBN-9B	Long Oval	9" x 4-1/4" x 2"	Doz	1/12
PWBN-9R	Round	9" x 2-3/4"	Doz	1/12
PWBN-9V	Oval	9-1/2" x 6-1/2" x 2-3/4"	Doz	1/12



PWBN-16B



NATURAL WOVEN BASKETS WITH HANDLES

ITEM	DESCRIPTION	SIZE	UOM	CASE
PWBN-12B	Rectangle with Handles	12" x 8" x 3"	Each	12/96
PWBN-16B	Rectangle with Handles	16" x 11" x 3"	Each	12/48

BLACK & GOLD WOVEN POLY BASKETS

◆ Wire reinforced



PWBK-SERIES

ITEM	DESCRIPTION	SIZE	UOM	CASE
PWBK-8R	Round	8-1/4" x 2-1/4"	Doz	1/12
PWBK-9B	Long Oval	8-3/4" x 3-7/8" x 2"	Doz	1/12
PWBK-9V	Oval	9" x 7" x 2-3/4"	Doz	1/12

POLY-PLASTIC PLATTERS & BASKETS

- ◆ Microwave and heat lamp safe up to 150°F (65°C)
- ◆ Dishwasher safe

NSF

BPA FREE

PLB-SERIES



FLAT BOTTOM PLATTERS

ITEM	DESCRIPTION	COLOR	UOM	CASE
PLB-G	10-3/4" x 7-1/4" x 1-1/2"	Green	Doz	12
PLB-K	10-3/4" x 7-1/4" x 1-1/2"	Black	Doz	12
PLB-R	10-3/4" x 7-1/4" x 1-1/2"	Red	Doz	12
PLB-Y	10-3/4" x 7-1/4" x 1-1/2"	Yellow	Doz	12

NSF

BPA FREE

POB-SERIES



OVAL BASKETS

ITEM	DESCRIPTION	COLOR	UOM	CASE
POB-G	10-1/4" x 6-3/4" x 2"	Green	Doz	12
POB-K	10-1/4" x 6-3/4" x 2"	Black	Doz	12
POB-R	10-1/4" x 6-3/4" x 2"	Red	Doz	12
POB-Y	10-1/4" x 6-3/4" x 2"	Yellow	Doz	12
PFB-10B	9-1/2" x 5" x 2"	Brown	Doz	3
PFB-10G	9-1/2" x 5" x 2"	Green	Doz	3
PFB-10R	9-1/2" x 5" x 2"	Red	Doz	3

BPA FREE

PFB-SERIES



COUNTERTOP SAFETY SHIELDS

All sizes are available solid or with pass-through window.

- ◆ Provides a clear, sanitary-positive barrier at point of sale
- ◆ Upholds friendly, face-to-face customer interaction
- ◆ Designed to stand on the countertop with sturdy supports
- ◆ Lightweight for ease of mobility
- ◆ Window opening: 12"W x 8"H
- ◆ Thickness: 6 mm

ITEM	DESCRIPTION	UOM	CASE
ACSS-2432	24"W x 32"H	Each	1
ACSS-2432W	24"W x 32"H with Pass-Through Window	Each	1
ACSS-3632	36"W x 32"H	Each	1
ACSS-3632W	36"W x 32"H with Pass-Through Window	Each	1
ACSS-4832	48"W x 32"H	Each	1
ACSS-4832W	48"W x 32"H with Pass-Through Window	Each	1

COUNTERTOP SAFETY SHIELDS



ACSS-2432



ACSS-2432W



ACSS-3632



ACSS-3632W



ACSS-4832



ACSS-4832W



ACSS-2432W



14" wide sturdy supports



12"W x 8"H pass-through window

MENU COVERS



Full size menu cover styles available in 3 colors

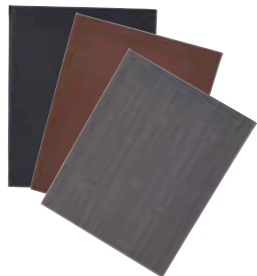

Chic leatherette menu covers provide an elegant yet durable display for full-service or fast casual restaurants alike. The double-sided stitched menu covers offer a refined, customized look without the customization wait times - a timeless style in a full collection to complement any décor.

- ◆ Secure interior picture corners
- ◆ Options for letter and legal size inserts
- ◆ 3 neutral color choices and patterns
- ◆ Common sizes and page configurations



SINGLE-VIEW MENU COVERS

- ◆ LMS-414BK fits 4-1/2" x 14" paper
- ◆ LMS-811 series fits 8-1/2" x 11" letter size paper
- ◆ LMS-814 series fits 8-1/2" x 14" legal size paper

ITEM	DESCRIPTION	COLOR	UOM	CASE
LMS-811BK	Letter Size	Black	Each	50
LMS-811BN	Letter Size	Brown	Each	50
LMS-811GY	Letter Size	Gray	Each	50
LMS-814BK	Legal Size	Black	Each	50
LMS-814GY	Legal Size	Gray	Each	50
LMS-414BK	Bar Size	Black	Each	50

TWO-VIEW MENU COVERS

- ◆ LMD-811 series fits 8-1/2" x 11" letter size paper
- ◆ LMD-814 series fits 8-1/2" x 14" legal size paper



ITEM	DESCRIPTION	COLOR	UOM	CASE
LMD-811BK	Letter Size	Black	Each	30
LMD-811BN	Letter Size	Brown	Each	30
LMD-811GY	Letter Size	Gray	Each	30
LMD-814BK	Legal Size	Black	Each	30
LMD-814BN	Legal Size	Brown	Each	30
LMD-814GY	Legal Size	Gray	Each	30

FOUR-VIEW MENU COVERS

- ◆ LMF-811 series fits 8-1/2" x 11" letter size paper
- ◆ LMF-814 series fits 8-1/2" x 14" legal size paper



ITEM	DESCRIPTION	COLOR	UOM	CASE
LMF-811BK	Letter Size	Black	Each	30
LMF-811BN	Letter Size	Brown	Each	30
LMF-811GY	Letter Size	Gray	Each	30
LMF-814BK	Legal Size	Black	Each	30
LMF-814BN	Legal Size	Brown	Each	30
LMF-814GY	Legal Size	Gray	Each	30

MENU TENTS

- ◆ 5" x 7" paper fits in menu tents



LMTD-57BK



LMTT-57BK

ITEM	DESCRIPTION	UOM	CASE
LMTD-57BK	Dual-View	Each	50
LMTT-57BK	Triple-View	Each	50

The edgings on all Winco® menu covers are double stitched to hold up to the wear and tear of regular, daily handling.

MENU COVERS & STAND

SINGLE POCKET MENU COVERS

- ◆ PMC-5 series fits 5-1/2" x 8" paper
- ◆ PMC-9 series fits 8-1/2" x 11" paper
- ◆ PMC-14 series fits 8-1/2" x 14" paper

ITEM	DESCRIPTION	UOM	CASE
PMC-5K	Black 6-3/8" x 9-3/8"	Each	25/200
PMC-5U	Burgundy 6-3/8" x 9-3/8"	Each	25/200
PMC-9B	Blue 9-3/8" x 12-1/8"	Each	25/200
PMC-9K	Black 9-3/8" x 12-1/8"	Each	25/200
PMC-9R	Red 9-3/8" x 12-1/8"	Each	25/200
PMC-9U	Burgundy 9-3/8" x 12-1/8"	Each	25/200
PMC-9G	Green 9-3/8" x 12-1/8"	Each	25/200
PMC-14K	Black 9-3/8" x 14-7/8"	Each	25/100
PMC-14U	Burgundy 9-3/8" x 14-7/8"	Each	25/100

Clear-view transparent sleeves



PMC-SERIES

BOOK-FOLD DOUBLE PANEL MENU COVERS

- ◆ PMCD-9 series fits 8-1/2" x 11" paper
- ◆ PMCD-14 series fits 8-1/2" x 14" paper

ITEM	DESCRIPTION	UOM	CASE
PMCD-9B	Blue 9-3/8" x 12-1/8"	Each	25/100
PMCD-9K	Black 9-3/8" x 12-1/8"	Each	25/100
PMCD-9R	Red 9-3/8" x 12-1/8"	Each	25/100
PMCD-9U	Burgundy 9-3/8" x 12-1/8"	Each	25/100
PMCD-9G	Green 9-3/8" x 12-1/8"	Each	25/100
PMCD-14K	Black 9-9/16" x 15"	Each	25/100
PMCD-14U	Burgundy 9-9/16" x 15"	Each	25/100



PMCD-9K

TRI-FOLD TRIPLE PANEL MENU COVERS

- ◆ PMCT-9 fits 8-1/2" x 11" paper

ITEM	DESCRIPTION	UOM	CASE
PMCT-9B	Blue 9-1/2" x 12-1/8"	Each	25/50
PMCT-9K	Black 9-1/2" x 12-1/8"	Each	25/50
PMCT-9R	Red 9-1/2" x 12-1/8"	Each	25/50
PMCT-9G	Green 9-1/2" x 12-1/8"	Each	25/50
PMCT-9U	Burgundy 9-1/2" x 12-1/8"	Each	25/50



PMCT-9K

FOUR POCKET BLACK MENU COVER

- ◆ PMCF-9 fits 8-1/2" x 11" paper

ITEM	DESCRIPTION	UOM	CASE
PMCF-9K	9-5/8" x 12-1/8"	Each	25/50



PMCF-9K

DOUBLE-SIDED CLEAR ACRYLIC MENU STANDS

- ◆ 2.0mm thickness

ITEM	DESCRIPTION	UOM	CASE
ATCH-46	4" x 6"	Each	12/36
ATCH-53	5-1/2" x 3-1/2"	Each	12/48
ATCH-57	5" x 7"	Each	12/36
ATCH-811	8" x 11"	Each	12/24



ATCH-811

TABLE SIGN HOLDERS/CLIPS

MENU/SIGN CLIPS

ITEM	DESCRIPTION	UOM	CASE
MH-1	Harp Clip, Heavy-Cast Base, 1"L x 1"W x 1-1/2"H	Doz	10/60
MH-2	Ring-Type, 2-1/2" x 2-1/3"	Doz	2/20
MH-2C	Clip, 2-1/2" x 2-1/2"	Doz	1/40



MH-1



MH-2



MH-2C



Card not included

TABLE NUMBER HOLDERS

◆ Mirror-finish chrome-plated steel

ITEM	DESCRIPTION	UOM	CASE
TBH-8	8"	Each	12/120
TBH-12	12"	Each	12/120
TBH-15	15"	Each	12/120
TBH-18	18"	Each	12/120



TBH-8



TBH-8 & TBN-25



TBH-12



TBH-12 & TBN-25



PLASTIC TABLE NUMBERS

- ◆ Numbers are printed on both sides
- ◆ Each number card measures 4" x 3-3/4"



TBN-SERIES

ITEM	DESCRIPTION	UOM	CASE
TBN-25	Numbers 1-25	Set	1/200
TBN-50	Numbers 1-50	Set	1/100
TBN-100	Numbers 1-100	Set	1/50

WINE SERVICE

4 QT STAINLESS STEEL WINE BUCKETS & STAND

- ◆ Long-lasting stainless steel, ideal for inside or outdoor tableside service
- ◆ Elegant mirror-finish for stylish display
- ◆ Easily transport wine buckets by the smooth knob or ring handles
- ◆ Simple 3-piece assembly for the wine bucket stand

ITEM	DESCRIPTION	SIZE	UOM	CASE
WB-4	4 Qt Wine Bucket, (No Retail Pkg)	7-1/2" Dia x 8" H	Each	6/24
WB-4HV	4 Qt Deluxe Wine Bucket	8" Dia x 10" H	Each	1/12
WB-29S	Pipe Style Stand* for WB-4 & WB-4HV	28-1/2" H	Each	1/6

*Assembly required



WB-4

WB-4HV

WB-29S

8 QT STAINLESS STEEL WINE BUCKET & STANDS

- ◆ Elegant mirror-finish for stylish display

ITEM	DESCRIPTION	UOM	CASE
WB-8	8 Qt Wine Bucket	Each	6/24
WB-8S	Stand* for WB-8	Each	1/12
WB-12FS	Folding Stand for WB-8	Each	1/6

*Assembly required



WB-12FS
Folded

WB-8S

WB-8



STAINLESS STEEL DOUBLE WALL WINE COASTERS

- ◆ Smooth or hammered satin-finish
- ◆ Fits 3-3/4" diameter wine bottles

ITEM	DESCRIPTION	SIZE	UOM	CASE
DWCC-5	Smooth Finish	4-5/8" Dia x 2-5/8" H	Each	12
DWCC-5H	Hammered Finish	4-5/8" Dia x 2-5/8" H	Each	12



DWCC-5H

DWCC-5

WINE COOLERS



ITEM	DESCRIPTION	SIZE	UOM	CASE
WC-60	Double Wall Hourglass, Mirror S/S	6" Dia x 7" H	Each	1/12
WC-7M	Marble, White	4 1/2" Dia x 7" H	Each	1/6
WC-5	Double Wall, Satin S/S (No Retail Pkg)	4 1/2" Dia x 7-3/4" H	Each	6/24
WC-4A	Acrylic, Clear	4 1/2" Dia x 9 1/4" H	Each	1/12



WC-60



WC-4A

WC-5

WC-7M



PLATE COVERS



PPCR-8



PPCR-10



PPCR-12



Secure stackability for transport

NSF PPCR-SERIES

POLYCARBONATE PLATE COVERS

Whether serving indoors or out, we've got you covered.

- ◆ Keep food hot and safe while serving
- ◆ Lids securely stack to hold up during transport
- ◆ Withstands temperatures up to 210°F (99°C)
- ◆ Clear cover for ease of viewing food
- ◆ Covers plates from 8" up to 12" in diameter
- ◆ Chip & break-resistant polycarbonate material
- ◆ Dishwasher safe

ITEM	DESCRIPTION	UOM	CASE
PPCR-8	8" Dia	Each	36
PPCR-9	9" Dia	Each	36
PPCR-10	10" Dia	Each	36
PPCR-11	11" Dia	Each	36
PPCR-12	12" Dia	Each	36



Upscale look and break-resistant, perfect for high-volume use

NON-SLIP SERVING TRAYS



DELUXE FIBERGLASS NON-SLIP TRAYS

- ◆ High durability fiberglass tray with self-molded, peel-resistant, non-slip surface
- ◆ Dishwasher safe

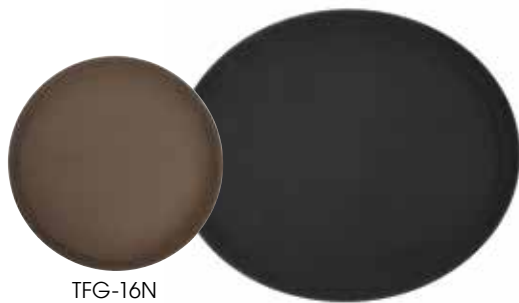

TFG-16N

TFG-2622K

NSF TFG FIBERGLASS SERIES

ITEM	DESCRIPTION	SIZE	COLOR	UOM	CASE
TFG-11K	Round	11"	Black	Each	1/12
TFG-11N	Round	11"	Brown	Each	1/12
TFG-14K	Round	14"	Black	Each	1/12
TFG-14N	Round	14"	Brown	Each	1/12
TFG-16K	Round	16"	Black	Each	1/12
TFG-16N	Round	16"	Brown	Each	1/12
TFG-2622K	Oval	26"x 22"	Black	Each	1/6
TFG-2622N	Oval	26"x 22"	Brown	Each	1/6



TRH-16

TRH-2722K

NSF TRH PLASTIC SERIES

EASY-HOLD RUBBER-LINED PLASTIC TRAYS

- ◆ Non-slip surface
- ◆ Hand wash only

ITEM	DESCRIPTION	SIZE	COLOR	UOM	CASE
TRH-11	Round	11"	Brown	Each	12
TRH-11K	Round	11"	Black	Each	12
TRH-14	Round	14"	Brown	Each	12
TRH-14K	Round	14"	Black	Each	12
TRH-16	Round	16"	Brown	Each	12
TRH-16K	Round	16"	Black	Each	12
TRH-1418	Rectangular	18" x 14"	Brown	Each	12
TRH-1418K	Rectangular	18" x 14"	Black	Each	12
TRH-2722	Oval	27" x 22"	Brown	Each	1/6
TRH-2722K	Oval	27" x 22"	Black	Each	1/6



TCK-16



CORK-LINED PLASTIC TRAYS

- ◆ Hand wash only

ITEM	DESCRIPTION	SIZE	UOM	CASE
TCK-14	Round	14"	Each	12/48
TCK-16	Round	16"	Each	12/36
TCK-16CK	Replacement Cork for TCK-16		Each	50/350

STAINLESS STEEL SERVING TRAYS

ITEM	DESCRIPTION	SIZE	UOM	CASE
STRS-12	Round	12"	Each	12/48
STRS-14	Round	14"	Each	12/24
STRS-16	Round	16"	Each	12/24

STAINLESS STEEL OVAL PLATTERS

ITEM	DESCRIPTION	SIZE	UOM	CASE
OPL-12	Oval	12" x 8-5/8"	Each	10/60
OPL-14	Oval	14" x 8-3/4"	Each	10/60
OPL-16	Oval	16" x 10-1/4"	Each	10/40
OPL-18	Oval	18" x 11-1/2"	Each	10/30
OPL-20	Oval	20" x 13-3/4"	Each	10/20
OPL-22	Oval	21-3/4" x 14-1/2"	Each	12

STAINLESS STEEL TRAYS & PLATTERS



STRS-14

OPL-14

CHROME-PLATED SERVING TRAYS

- ◆ Limit use with meat or acidic ingredients
- ◆ Hand wash only

ITEM	DESCRIPTION	SIZE	UOM	CASE
CMT-1912	Rectangular w/Handles	19-1/2" x 12-1/2"	Each	12/24
CMT-1217	Octagonal	17" x 12-1/2"	Each	12/24
CMT-1420	Octagonal	20" x 14"	Each	12/24
CMT-1812	Rectangular	18" x 12-1/2"	Each	12/24
CMT-2014	Rectangular	20" x 14"	Each	12/24
CMT-1014	Oval	14-3/4" x 10-1/2"	Each	12/24
CMT-1318	Oval	18-3/4" x 13"	Each	12/24
CMT-14	Round	14"	Each	12/24

CHROME SERVING TRAYS

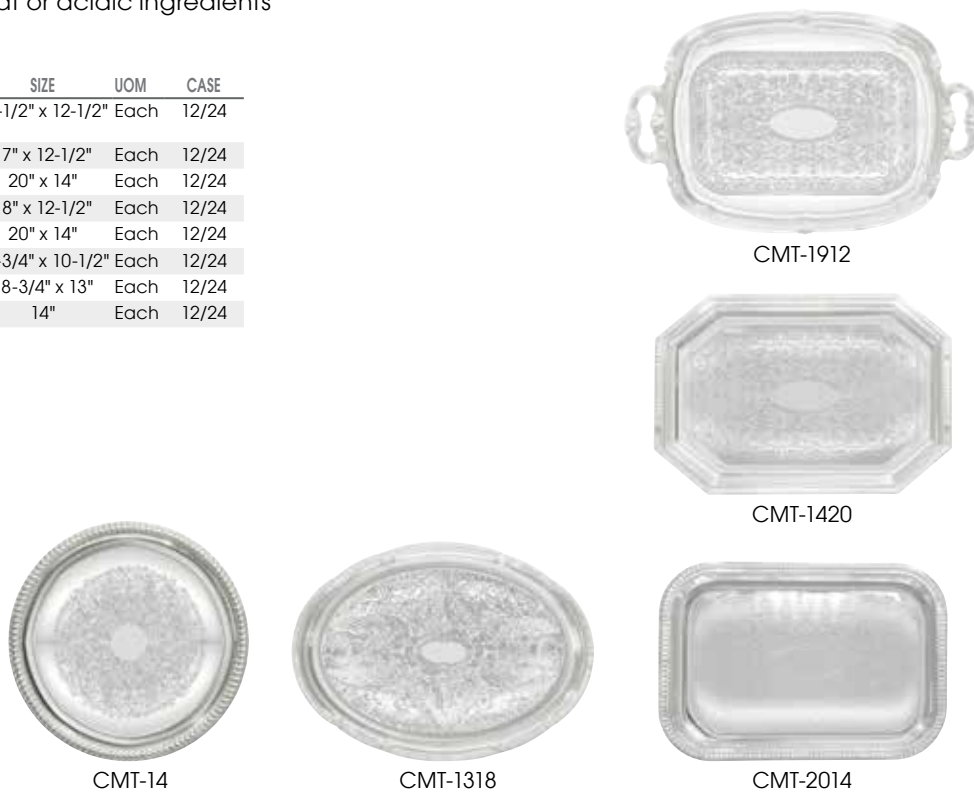

CMT-1912

CMT-1420

CMT-14

CMT-1318

CMT-2014

TRAY STANDS

ITEM	DESCRIPTION	SIZE	UOM	CASE
TSY-1A	Chrome Steel	31"	Each	6
TR-33W	Rubberwood, Walnut	32"	Each	1
TR-34W	Rubberwood, Mahogany	32"	Each	1

TRAY STANDS



TR-34W

TR-33W

TSY-1A

DINING & SERVING TRAYS



Reinforced bottom

3 POPULAR SIZES

7 COLORS PER SIZE



FFT-SERIES

HIGH-QUALITY PLASTIC CAFETERIA TRAYS

◆ Resists warping with frequent use

ITEM	DESCRIPTION	COLOR	UOM	CASE
FFT-1014B	10" x 14"	Brown	Each	12/48
FFT-1014E	10" x 14"	Grey	Each	12/48
FFT-1014G	10" x 14"	Green	Each	12/48
FFT-1014K	10" x 14"	Black	Each	12/48
FFT-1014O	10" x 14"	Orange	Each	12/48
FFT-1014R	10" x 14"	Red	Each	12/48
FFT-1014U	10" x 14"	Burgundy	Each	12/48
FFT-1216B	12" x 16"	Brown	Each	12/48
FFT-1216E	12" x 16"	Grey	Each	12/48
FFT-1216G	12" x 16"	Green	Each	12/48
FFT-1216K	12" x 16"	Black	Each	12/48
FFT-1216O	12" x 16"	Orange	Each	12/48
FFT-1216R	12" x 16"	Red	Each	12/48
FFT-1216U	12" x 16"	Burgundy	Each	12/48
FFT-1418B	14" x 18"	Brown	Each	12/48
FFT-1418E	14" x 18"	Grey	Each	12/48
FFT-1418G	14" x 18"	Green	Each	12/48
FFT-1418K	14" x 18"	Black	Each	12/48
FFT-1418O	14" x 18"	Orange	Each	12/48
FFT-1418R	14" x 18"	Red	Each	12/48
FFT-1418U	14" x 18"	Burgundy	Each	12/48



ACVP-0608

ALUMINUM SERVING TRAY - OPEN BEAD

◆ Wide corners and open rim for easy cleaning

ITEM	DESCRIPTION	GAUGE	UOM	CASE
ACVP-0608	6" x 8"	14	Each	24



ALUMINUM SERVING TRAYS - CLOSED BEAD

- ◆ Reinforced galvanized wire rim
- ◆ Made of 3003 aluminum

ITEM	DESCRIPTION	GAUGE	UOM	CASE
ALXP-1013	9-1/2" x 13"	1/4-Size	20	Each 24
ALXP-1318	13" x 18"	1/2-Size	20	Each 12



ALXP-1013

STAINLESS STEEL 6 COMPARTMENT MESS TRAYS

◆ Mirror finish; Dishwasher safe

ITEM	DESCRIPTION	UOM	CASE
SMT-1	15-1/2" x 11-1/2"	Each	24
SMT-2	15-1/2" x 11-1/2"	Each	24



SMT-1



SMT-2

POLY-PLASTIC FLAT BOTTOM PLATTERS

- ◆ Microwave and heat lamp safe up to 150°F (65°C)
- ◆ Dishwasher safe

ITEM	DESCRIPTION	COLOR	UOM	CASE
PLB-G	10-3/4" x 7-1/4" x 1-1/2"	Green	Doz	12
PLB-K	10-3/4" x 7-1/4" x 1-1/2"	Black	Doz	12
PLB-R	10-3/4" x 7-1/4" x 1-1/2"	Red	Doz	12
PLB-Y	10-3/4" x 7-1/4" x 1-1/2"	Yellow	Doz	12

SERVING BASKETS



PLB-SERIES

POLY-PLASTIC OVAL BASKETS

- ◆ Microwave and heat lamp safe up to 150°F (65°C)
- ◆ Dishwasher safe

ITEM	DESCRIPTION	COLOR	UOM	CASE
POB-G	10-1/4" x 6-3/4" x 2"	Green	Doz	12
POB-K	10-1/4" x 6-3/4" x 2"	Black	Doz	12
POB-R	10-1/4" x 6-3/4" x 2"	Red	Doz	12
POB-Y	10-1/4" x 6-3/4" x 2"	Yellow	Doz	12
PFB-10B	9-1/2" x 5" x 2"	Brown	Doz	3
PFB-10G	9-1/2" x 5" x 2"	Green	Doz	3
PFB-10R	9-1/2" x 5" x 2"	Red	Doz	3



POB-SERIES

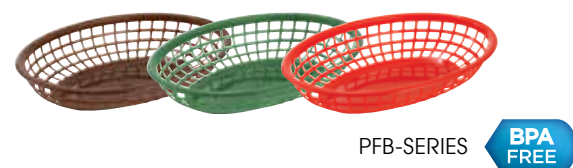

PFB-SERIES

DECORATIVE BAMBOO FOOD PICKS

- ◆ Versatile solution to hold together sandwiches/wraps or garnish beverages with style
- ◆ Knotted end allows easy pick-up of individual portions
- ◆ Eco-friendly

ITEM	DESCRIPTION	SIZE	PCS/BAG	UOM	CASE
PK-KT3	Bamboo	3"	100	Pack	12/120
PK-KT4	Bamboo	4"	100	Pack	12/120
PK-KT7	Bamboo	7"	100	Pack	12/120



DECORATIVE PICKS



100pcs per pack, per size



PK-KT7 PK-KT4 PK-KT3

DECORATIVE WOOD & PLASTIC FOOD PICKS

- ◆ Hanging retail packaging

ITEM	DESCRIPTION	SIZE	PCS/BAG	UOM	CASE
PK-P4	Parasol	3-15/16"	144	Bag	100
PK-C2	Cellophane Frills	2-9/16"	1,000	Bag	10
PK-C4	Cellophane Frills	3-15/16"	1,000	Bag	10
PK-A35	Plastic Arrow	3-7/16"	500	Bag	20
PK-S3	Plastic Sword	2-3/4"	500	Bag	20



PK-P4



PK-S3



PK-A35



PK-C4



PK-C2

BAGEL SLICER



5"L x 2-1/4"W slot

NSF BGS-1

POLYCARBONATE BAGEL SLICER

- ◆ High-carbon, non-stick blade with serrated edge provides precise cuts with every slice
- ◆ Clear guard allows visibility & protects hands/fingers from injury
- ◆ Wide base helps maintain stability while in use

ITEM	DESCRIPTION	UOM	CASE
BGS-1	7"L x 3-1/2"W x 9"H	Set	1/12
BGS-1B	Replacement Blade with Guard	Each	1/12

CONDIMENT DISPENSER



PKTS-2D

BPA FREE PKTS-SERIES

CONDIMENT DISPENSER

- ◆ Removable plastic fountain jars for easy cleaning/refilling
- ◆ Durable 18/8 stainless steel, heavy duty pump
- ◆ Two (2) 3-1/2 Qt plastic fountain jars included (7 Qt total)
- ◆ Each pump dispenses between 1 oz and 1-1/4 oz portions, depending on thickness of condiments
- ◆ 11"L x 8-3/4"W x 16"H (with pump)

ITEM	DESCRIPTION	UOM	CASE
PKTS-2D	Condiment Dispenser with 2 Standard Pumps	Set	1
PKTS-PT01	Individual Pump with Lid	Each	20
PKTS-PT02	Replacement Plastic Fountain Jar	Each	6
PKTS-PT03	Stainless Steel Casing	Each	1

SQUEEZE BOTTLES



PSW-CAP

Fits both PSW- and PSB-Series lids



48 caps per pack



PSW-24

BPA FREE PSW-SERIES

WIDE-MOUTH SQUEEZE BOTTLES

- ◆ Open tip ready to use - no need for cutting
- ◆ Wide mouth for easier refilling and cleaning
- ◆ Leak-free design

ITEM	DESCRIPTION	COLOR	UOM	CASE
PSW-12	12 Oz	Clear	Pack	1/12
PSW-12R	12 Oz	Red	Pack	1/12
PSW-12Y	12 Oz	Yellow	Pack	1/12
PSW-16	16 Oz	Clear	Pack	1/8
PSW-16R	16 Oz	Red	Pack	1/8
PSW-16Y	16 Oz	Yellow	Pack	1/8
PSW-24	24 Oz	Clear	Pack	1/8
PSW-24R	24 Oz	Red	Pack	1/8
PSW-24Y	24 Oz	Yellow	Pack	1/8
PSW-32	32 Oz	Clear	Pack	1/6
PSW-32R	32 Oz	Red	Pack	1/6
PSW-32Y	32 Oz	Yellow	Pack	1/6
PSW-C-LID	Replacement Lid	Clear	Doz	60
PSW-Y-LID	Replacement Lid	Yellow	Doz	60
PSW-CAP	Cap, 48-pcs/pk	Red	Pack	480



6 bottles per pack



BPA FREE PSB-SERIES

SQUEEZE BOTTLES

- ◆ Open tip ready to use - no need for cutting

ITEM	DESCRIPTION	COLOR	UOM	CASE
PSB-08C	8 Oz	Clear	Pack	1/12
PSB-08R	8 Oz	Red	Pack	1/12
PSB-08Y	8 Oz	Yellow	Pack	1/12
PSB-12C	12 Oz	Clear	Pack	1/12
PSB-12R	12 Oz	Red	Pack	1/12
PSB-12Y	12 Oz	Yellow	Pack	1/12
PSB-24C	24 Oz	Clear	Pack	1/6
PSB-24R	24 Oz	Red	Pack	1/6
PSB-24Y	24 Oz	Yellow	Pack	1/6
PSB-C-LID	Replacement Lid	Clear	Doz	60
PSW-CAP	Cap, 48-pcs/pk	Red	Pack	480

PLASTIC ROTARY CHEESE GRATER

- ◆ Ideal for grating hard cheese or chocolate
- ◆ Includes 2 interchangeable drums for fine or coarse grating
- ◆ Dishwasher safe

ITEM	DESCRIPTION	UOM	CASE
PRTS-2	7"L x 3-1/2"W x 4"H	Each	6/24

TABLESIDE SERVICE



PRTS-2

ZESTER GRATERS

- ◆ 18/8 stainless steel blade
- ◆ Comes with cover for the blade
- ◆ Comfortable soft-grip handle
- ◆ Superior anti-corrosion properties and durability

ITEM	DESCRIPTION	UOM	CASE
GT-103	Medium Coarse Blade	Each	12/72
GT-104	Zester Blade	Each	12/72
GT-105	Fine Blade	Each	12/72
GT-106	Ribbon Blade	Each	12/72



CHEESE KNIFE SETS

- ◆ Each set includes 6 knives for hard, soft, firm or crumbly cheeses
- ◆ Stainless steel blades

ITEM	DESCRIPTION	UOM	CASE
KCS-6	6-Pc Set w/POM Hdls	Set	1/24
KCS-6W	6-Pc Set w/Wooden Hdls	Set	6/48



WOOD BREAD/CHEESE BOARDS

- ◆ Built-in knife slot

ITEM	DESCRIPTION	UOM	CASE
WCB-125	12" x 5" x 3/4"	Each	24
WCB-225	22-1/2"L x 5-1/2"W x 3/4"H	Each	12



WCB-125



WCB-225



Shown with
cheese knife
set #KCS-6



SEAFOOD SERVICE



ASFT-12



SFR-4

ALUMINUM SEAFOOD TRAYS

◆ The brushed aluminum construction retains cold and keeps foods at safe serving temperatures.

ITEM	DESCRIPTION	UOM	CASE
ASFT-12	12"Dia x 1-1/2"H	Each	12/36
ASFT-14	13-3/4"Dia x 1-1/2"H	Each	12/36
ASFT-16	15-3/4"Dia x 1-1/2"H	Each	12/24
ASFT-18	17-3/4"Dia x 1-1/2"H	Each	12/24
ASFT-20	19-3/4"Dia x 1-1/2"H	Each	12



CHROME-PLATED SEAFOOD TRAY DISPLAY RACKS

◆ Use with ASFT-series seafood trays to create appealing tabletop presentations

ITEM	DESCRIPTION	UOM	CASE
SFR-4	7-3/8" Top Dia / 9-5/8" Bottom Dia x 4-3/8"H	Each	20
SFR-7	7-3/8" Top Dia / 9-5/8" Bottom Dia x 7"H	Each	20



LC-85



LC-01



LC-03



LC-04



LC-05

LOBSTER CRACKERS

ITEM	DESCRIPTION	SIZE	UOM	CASE
LC-01	Stainless Steel	6"	Each	12/72
LC-03	Chrome Plated, Large	6"	Each	12/144
LC-04	Nut/Lobster Cracker	4-3/4"	Each	24/144
LC-05	Zinc Alloy	6"	Each	12/72
LC-85	Zinc Alloy, Carded	6"	Each	12/72



18/8 STAINLESS STEEL SEAFOOD PICKS

◆ Decorative lobster stamp
◆ Narrow two-tine fork designed to effortlessly extract more shellfish meat

ITEM	DESCRIPTION	UOM	CASE
LC-08	8"L x 3/4"W, 4-Pcs/Pk	Pack	30/120



LC-08

4pcs per pack



Decorative stamp



SBW-35

BUTTER WARMER

◆ Set includes wire stand, stainless steel butter pan, glass votive holder and candle

ITEM	DESCRIPTION	UOM	CASE
SBW-35	4-Pc Set	Set	1/48



SND-6



SND-T6



SND-F7

STAINLESS STEEL SNAIL SERVICE

◆ Neatly serve escargot

ITEM	DESCRIPTION	UOM	CASE
SND-6	Dish, 6 Wells	Each	12/144
SND-T6	Tongs	Each	12/120
SND-F7	Fork	Doz	1/50

TABLE CRUMBERS



ATC-16G



ATC-16S

ALUMINUM TABLE CRUMBERS

◆ 6" long, featuring a pocket clip

ITEM	DESCRIPTION	UOM	CASE
ATC-16G	Gold	Each	120/600
ATC-16S	Silver	Each	120/600

ALUMINUM ORDER RACKS

- ◆ Occupies less space, easily fits onto narrow counter edges
- ◆ Packaged in retail hanging pack

ITEM	DESCRIPTION	UOM	CASE
ODR-18N	18"	Each	12/24
ODR-24N	24"	Each	12/24
ODR-36N	36"	Each	12/24
ODR-48N	48"	Each	12/24
ODR-60N	60"	Each	1/12

ORDER RACKS & CALL BELLS

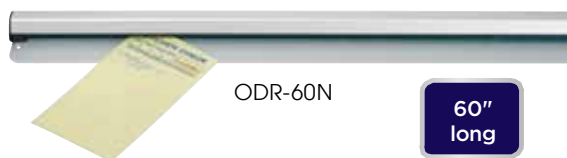

ODR-60N

60" long

CALL BELLS

- ◆ Chrome plated with plastic base

ITEM	DESCRIPTION	UOM	CASE
CBEL-1	3-1/2"Dia	Each	12/144
CBEL-2	4"Dia	Each	12/72



CBEL-2



CBEL-1

STAINLESS STEEL TABLE SIGNS

Compact size, ideal for tabletops.

- ◆ Highly visible bold lettering

ITEM	DESCRIPTION	UOM	CASE
RVS-4	4-3/4" x 1-3/4"	Each	12/120
SGN-106	3"L x 1-1/2"D x 1-1/4"H	Each	12/120

TABLE SIGNS



RVS-4



SGN-106

BLACK CHECK PRESENTERS

- ◆ Convenient carry size or easily slip into apron pocket
- ◆ Credit card slot; slanted pockets for receipt/order pad/tips
- ◆ Center clear sleeve for displaying daily specials, drinks or deserts (CHK-3K)

ITEM	DESCRIPTION	UOM	CASE
CHK-1K	5-1/2" x 10"	Each	12/96
CHK-2K	5-1/4" x 8-1/2" w/Elastic Pen Loop	Each	12/96
CHK-3K	4-1/2" x 9", Flexible Spine	Each	24/96

CHECK SERVICE



CHK-3K



CHK-2K



CHK-1K

CHECK CADDY

ITEM	DESCRIPTION	UOM	CASE
CS-3	3"Dia, Brass-Plated	Each	12/36

CHECK SPINDLE

ITEM	DESCRIPTION	UOM	CASE
CS-1	6" H, Steel Wire	Each	12/240

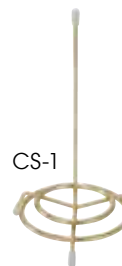

CS-1

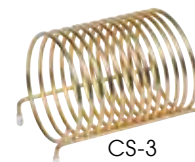

CS-3

TIP TRAY

ITEM	DESCRIPTION	UOM	CASE
TT-46	4-1/2" x 6-1/2"	Doz	1/12

COUNTERFEIT DETECTION PEN

- ◆ Fast and easy way to detect fraudulent bills
- ◆ Can be used with other counterfeit detection methods
- ◆ 2 pieces per pack

ITEM	DESCRIPTION	UOM	CASE
PPM-2	2-Pcs/Pk	Pack	18/72



PPM-2



TT-46

AUTOMATIC HAND-SANITIZER DISPENSER



SDT-8S

AUTOMATIC HAND-SANITIZER TABLE/COUNTERTOP DISPENSER

- ◆ **Hands-free** dispensing reduces cross-contamination
- ◆ Compact, durable construction
- ◆ Holds up to 8 ounces of hand-sanitizer

ITEM	DESCRIPTION	UOM	CASE
SDT-8S	Brushed Nickel	Each	24



4-level adjustable dispensing volume



Easy to operate and refill



4 AAA batteries required (not included)

CONDIMENT PACKET HOLDER



*Pans sold separately



SCPH-33

18/8 STAINLESS STEEL CONDIMENT PACKET HOLDER

- ◆ Fits various configurations 1/3, 1/6 and 1/9-size steam table pans*
- ◆ Ideal for keeping sugar, salt or sauce packets organized
- ◆ Two openings, each measures 12"L x 6-1/8"W
- ◆ Sloped angle allows easy access on crowded countertops

ITEM	DESCRIPTION	UOM	CASE
SCPH-33	16"L x 13-1/2"W x 9-1/4"H	Each	1/2

Refer to Steam Table Pans for complete food pan range

TABLETOP DISPENSERS



BPA FREE ACSD-712



BPA FREE ACTD-3

ACRYLIC STRAW DISPENSER

- ◆ Easily turn the roller to dispense a straw
- ◆ Holds up to 250, 10" long straws

ITEM	DESCRIPTION	UOM	CASE
ACSD-712	10-3/4" x 4-3/4" x 7"	Each	6

ACRYLIC TOOTHPICK DISPENSER

- ◆ Turn the roller to dispense a toothpick

ITEM	DESCRIPTION	UOM	CASE
ACTD-3	3" x 2-1/2" x 4"	Each	6/36

STAINLESS STEEL NAPKIN DISPENSERS

ITEM	DESCRIPTION	UOM	CASE
NH-5	3-1/2"W x 5"H	Each	1/36
NH-7	3-1/2"W x 7"H	Each	1/36



NH-5



NH-7



BPA FREE SDP-3

SAN PLASTIC VERTICAL STRAW DISPENSER

- ◆ Clear, break-resistant SAN plastic cylinder
- ◆ Stainless steel pull-up lid and dispenser insert
- ◆ Holds up to 100, 10" long straws

ITEM	DESCRIPTION	UOM	CASE
SDP-3	3-3/8"Dia x 10-3/4"H	Each	1/12

STAINLESS STEEL MINI SWING-LID WASTE CAN

- ◆ 4-3/4" diameter x 6" tall
- ◆ Compact size ideal for use on table or countertop

ITEM	DESCRIPTION	UOM	CASE
DDSF-101S	S/S Mini Waste Can	Each	12/48

MINI WASTE CAN



DDSF-101S

STAINLESS STEEL ASHTRAY

- ◆ 4" diameter
- ◆ Stackable

ITEM	DESCRIPTION	UOM	CASE
SAS-4	S/S Ashtray	Each	24/96

ASHTRAYS



SAS-4

PLASTIC MELAMINE ASHTRAYS

- ◆ 4" diameter with slots for 6 cigarettes and 1 cigar
- ◆ Stackable; 1-1/2" deep well
- ◆ Heat resistant up to 380°F (193°C)

ITEM	DESCRIPTION	COLOR	UOM	CASE
MAS-4K	Melamine Ashtray	Black	Doz	12
MAS-4R	Melamine Ashtray	Red	Doz	12



MAS-4R



MAS-4K

RECHARGEABLE TEALIGHTS

- ◆ A complete charge provides 12 hours of simulated flickering candle light
- ◆ 12 tealights, each with ON/OFF switch on the bottom
- ◆ Includes charging base, 120V adapter and NiMH battery
- ◆ Tealights: 1-5/8" diameter x 2" high
- ◆ Cylinders: 1-3/4" diameter x 4" high

ITEM	DESCRIPTION	UOM	CASE
CLR-12S	Rechargeable Tealights	Set	1/12

TEALIGHTS



CL-L

CLR-12S 

BATTERY-OPERATED TEALIGHT

- ◆ One CR2032 battery included
- ◆ 60 hours of battery life

ITEM	DESCRIPTION	UOM	CASE
CL-L	1-1/2"Dia x 1-1/2"H	Each	12/240

STABLEIZER TABLE WEDGES/SHIMS

Put an end to wobble tables! Quickly *STABLEize* customers' common complaint of wobbly tables with these economical and practical plastic wedges.

- ◆ Stop the rocking with a single shim or stack to stabilize
- ◆ Align adjacent tables when seating larger parties
- ◆ Each wedge measures 2"L x 1-1/4"W x up to 1/4"H
- ◆ 75 pieces per pack

ITEM	DESCRIPTION	COLOR	UOM	CASE
TW-75B	Flexible	Black	Pack	48
TW-75W	Rigid	Translucent	Pack	48

TABLE WEDGES/SHIMS



TW-75B





TW-75W



Stackable for customized leveling

 **Protect** your guests' experience

 **Alleviate** staff aggravation

 **Save** on expense of replacing tables and losing customers to dreaded wobbly tables



75 pieces per container

WAIT SERVICE APRONS

SIGNATURE CHEF



BADN-3126

Individually packaged in printed poly-bag



Color box with full case purchase



BADN-3430

HEAVYWEIGHT DENIM BIB APRON, CROSS-BACK

Stylish and functional, the dark wash denim masks spills and stains while keeping up appearances.

- ◆ 80/20 cotton-poly blend dark wash denim
- ◆ Contrast stitching and brass rivet details
- ◆ Cross-back straps adjust for best fit
- ◆ Two (2) slanted waist pockets
- ◆ Thermometer/pen pocket
- ◆ 31-3/4"L x 26-3/4"W
- ◆ Color display box only available with full case (FC) qty

ITEM	COLOR	UOM	CASE
BADN-3126	Dark Wash w/Brown Straps	Each	12/24



Cross-back



Leather strap divider

HEAVYWEIGHT DENIM BIB APRON, ADJUSTABLE NECK

Hard-wearing style that can handle the hustle. Adjust the neck strap to achieve the perfect length.

- ◆ 80/20 cotton-poly blend dark wash denim
- ◆ Adjustable neck accommodates most heights
- ◆ Two (2) vertical waist pockets
- ◆ Open chest pocket
- ◆ Zippered cell-phone pocket
- ◆ 34-1/2"L x 30-1/4"W
- ◆ Color display box only available with full case (FC) qty

ITEM	COLOR	UOM	CASE
BADN-3430	Dark Wash w/Gray Straps	Each	12/24



Adjustable neck strap

MID-WEIGHT BIB APRONS

The perfect addition to uniforms calling for a streamlined look.

- ◆ Blue apron is 65/35 poly-cotton blend
- ◆ Black apron is 80/20 poly-cotton blend
- ◆ Adjustable snap-button neck strap for the best fit
- ◆ Thermometer/pen pocket
- ◆ Eight (8) varying size waist pockets to hold supplies
- ◆ 33-1/2"L x 27"W

◆ Color display box only available with full case (FC) qty

ITEM	COLOR	UOM	CASE
BA-3327B	Blue	Each	24/48
BA-3327K	Black	Each	24/48

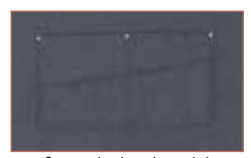

INDIVIDUALLY PACKAGED IN PRINTED POLY-BAG

WOVEN CHALKSTRIPE BIB APRON

The stripe pattern of this bib apron is woven in, making for a lasting appearance that stands up to busy service and bartending shifts.

- ◆ 65/35 poly-cotton blend
- ◆ Two (2) waist pockets; designed to hold digital tablets up to 8" wide
- ◆ 33-1/2"L x 27"W

ITEM	DESCRIPTION	UOM	CASE
BA-3427CS	Chalkstripe w/Pockets	Each	12/60



INDIVIDUALLY PACKAGED IN PRINTED POLY-BAG

3-POCKET MID-LENGTH BIB APRONS

- ◆ 65/35 poly-cotton blend
- ◆ Adjustable neck strap
- ◆ 24"L x 27-1/2"W

ITEM	COLOR	UOM	CASE
BA-2724W	White	Each	12/60
BA-2724K	Black	Each	12/60



WAIT SERVICE APRONS

SIGNATURE CHEF



BA-PBL
Model: 6'



BA-SERIES, WITHOUT POCKETS



Available Colors

BA-SERIES, WITH PEN & PAD POCKETS



FULL-LENGTH BIB APRONS

- ◆ Pen and pad pockets on select items
- ◆ Cotton-poly blend, machine wash and dry; wrinkle-resistant
- ◆ Assorted colors available
- ◆ 33"L x 26"W

ITEM	DESCRIPTION	UOM	CASE
BA-3226WH	White, No Pockets	Each	12/60
BA-3226BK	Black, No Pockets	Each	12/60
BA-PBG	Burgundy, w/Pockets	Each	12/60
BA-PBK	Black, w/Pockets	Each	12/60
BA-PBL	Blue, w/Pockets	Each	12/60
BA-PGN	Green, w/Pockets	Each	12/60
BA-PLG	Light Green, w/Pockets	Each	12/60
BA-PRD	Red, w/Pockets	Each	12/60
BA-PWH	White, w/Pockets	Each	12/60

INDIVIDUALLY
PACKAGED IN
PRINTED POLY-BAG



WA-3129WH

WA-3129BK



BISTRO FULL LENGTH APRONS

These full length bistro/waist aprons are a versatile addition to staff uniforms, easily transitioning from casual to formal, all with a polished look.

- ◆ 65/35 poly-cotton blend
- ◆ 2 large utility pockets; fits most digital tablets

ITEM	DESCRIPTION	UOM	CASE
WA-3129WH	White	Each	12/60
WA-3129BK	Black	Each	12/60

INDIVIDUALLY
PACKAGED IN
PRINTED POLY-BAG



WA-2819W

WA-2819K



BISTRO HALF LENGTH APRONS

Simple and crisp, the half length bistro aprons are adaptable across a multitude of settings.

- ◆ 65/35 poly-cotton blend
- ◆ 2 utility pockets; fits most digital tablets
- ◆ 19"L x 28"W

ITEM	DESCRIPTION	UOM	CASE
WA-2819W	White	Each	12/60
WA-2819K	Black	Each	12/60

FOUR-WAY APRONS

These aprons offer four surfaces for a quick-flip change to present a clean side on the fly, without the need for switching to a new apron.

- ◆ 65/35 poly-cotton blend
- ◆ 17"L x 34"W

ITEM	DESCRIPTION	UOM	CASE
WA4-3417W	White	Each	12/60
WA4-3417K	Black	Each	12/60



Models (L to R): 6' / 5' 3" / 5' 7"

WAIT SERVICE APRONS



SIGNATURE CHEF

4 aprons in one



WA4-3417W



WA4-3417K

INDIVIDUALLY PACKAGED IN PRINTED POLY-BAG

3-POCKET WAIST APRONS

- ◆ Cotton-poly blend, machine wash and dry, wrinkle resistant
- ◆ Available in 4 colors
- ◆ 12-1/2"L x 21-3/4"W

ITEM	DESCRIPTION	UOM	CASE
WA-1221	Black	Each	12/60
WA-1221G	Green	Each	12/60
WA-1221R	Burgundy	Each	12/60
WA-1221RED	Red	Each	12/60
WA-1221W	White	Each	12/60



WA-1221



WA-1221R



WA-1221G



WA-1221RW



WA-1221RED



REUSABLE FACE MASKS

SIGNATURE CHEF



M/L L/XL



Camouflage, Adjustable



Gray, Adjustable



White, Adjustable



Black, Adjustable



White



Black

REUSABLE & ADJUSTABLE 2-PLY COTTON/POLY FACE MASKS

- ◆ Outer: 100% Polyester, Lining: 60/40 Cotton/Poly
- ◆ Machine washable
- ◆ Non-medical grade
- ◆ Comfort fit with contoured nose
- ◆ Adjustable soft elastic ear loops for lasting comfort

ITEM	COLOR	SIZE	UOM	CASE
MSK-3ML	Camo	M/L	2 Pcs/Pk	50/250
MSK-3LXL	Camo	L/XL	2 Pcs/Pk	50/250
MSK-4GML	Gray	M/L	2 Pcs/Pk	50/250
MSK-4GLXL	Gray	L/XL	2 Pcs/Pk	50/250



2 per pack, per style

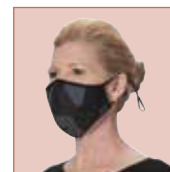

REUSABLE & ADJUSTABLE 2-PLY COTTON FACE MASKS

- ◆ 100% Cotton
- ◆ Machine washable
- ◆ Non-medical grade
- ◆ Comfort fit with contoured nose
- ◆ Adjustable soft elastic ear loops for lasting comfort

ITEM	COLOR	SIZE	UOM	CASE
MSK-2WML	White	M/L	2 Pcs/Pk	50/250
MSK-2WLXL	White	L/XL	2 Pcs/Pk	50/250
MSK-2KML	Black	M/L	2 Pcs/Pk	50/250
MSK-2KLXL	Black	L/XL	2 Pcs/Pk	50/250

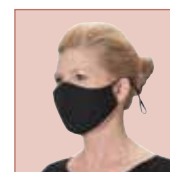

REUSABLE 2-PLY COTTON FACE MASKS

- ◆ 100% Cotton
- ◆ Machine washable
- ◆ Non-medical grade
- ◆ Comfort fit with contoured nose
- ◆ Soft elastic ear loops for lasting comfort

ITEM	COLOR	SIZE	UOM	CASE
MSK-1WML	White	M/L	2 Pcs/Pk	50/250
MSK-1WLXL	White	L/XL	2 Pcs/Pk	50/250
MSK-1KML	Black	M/L	2 Pcs/Pk	50/250
MSK-1KLXL	Black	L/XL	2 Pcs/Pk	50/250



FACE SHIELD



PFS-1



1-1/8" thick comfortable foam padding



Compatible w/ glasses and face mask

FACE SHIELD

Built to protect employees and customers from airborne contaminants.

- ◆ Provides a secure fit, with wide elastic headband to keep shield in place
- ◆ Extremely lightweight for long-lasting wear
- ◆ Thick foam padding for extra comfort
- ◆ Ultra-clear and anti-fog
- ◆ Compatible with safety glasses and/or other face masks

ITEM	DESCRIPTION	UOM	CASE
PFS-1	13" x 8-1/2"	Each	25/50

WHITE COTTON SERVICE GLOVES

Elevate the dining experience with white glove service.

- ◆ 100% cotton
- ◆ 12 gloves (6 pairs) per pack

ITEM	DESCRIPTION	COLOR	UOM	CASE
GLC-M	Medium Gloves	White	Doz	100
GLC-L	Large Gloves	White	Doz	100



6 pairs
per pack

GLC-M

COAT HANGERS

- ◆ Sturdy metal hanging hook
- ◆ Notched arms prevent garments from slipping
- ◆ Drape pants or scarves over the horizontal bar

ITEM	DESCRIPTION	UOM	CASE
WCH-1	Wooden Coat Hangers	Doz	1/10



12 per
box

WCH-1

COAT CHECK TICKETS

- ◆ Large, easy-read numbering
- ◆ Perforations tear without ripping
- ◆ Large hole fits over hanger hook

ITEM	DESCRIPTION	COLOR	UOM	CASE
CCK-5BL	500 Tickets	Blue	Box	20
CCK-5PK	500 Tickets	Pink	Box	20
CCK-5WT	500 Tickets	White	Box	20
CCK-5YL	500 Tickets	Yellow	Box	20



CCK-5BL



CCK-5PK

500 per
box



CCK-5WT



CCK-5YL

TABLE CLOTHS

- ◆ Plastic checkered pattern with cotton lining

ITEM	DESCRIPTION	COLOR	UOM	CASE
TBCS-52B	52" x 52" Square	Blue	Each	24
TBCS-52G	52" x 52" Square	Green	Each	24
TBCS-52R	52" x 52" Square	Red	Each	24
TBCS-52K	52" x 52" Square	Black	Each	24
TBCO-70B	52" x 70" Rectangle	Blue	Each	24
TBCO-70G	52" x 70" Rectangle	Green	Each	24
TBCO-70R	52" x 70" Rectangle	Red	Each	24
TBCO-70K	52" x 70" Rectangle	Black	Each	24
TBCO-90B	52" x 90" Rectangle	Blue	Each	24
TBCO-90G	52" x 90" Rectangle	Green	Each	24
TBCO-90R	52" x 90" Rectangle	Red	Each	24
TBCO-90K	52" x 90" Rectangle	Black	Each	24

TABLE CLOTHS & CLIPS

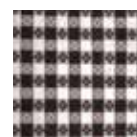

Black



Red



TBCS, RED



Green



Blue

TBCS & TBCO-SERIES

STAINLESS STEEL TABLE CLOTH CLIP

- ◆ Securely holds tablecloth in place
- ◆ Fits up to 1-1/2" thick table tops

ITEM	DESCRIPTION	UOM	CASE
TBC-1	S/S Table Cloth Clip	Doz	6/60



TBC-1

12 per
pack

FLATWARE ORGANIZERS



FC-PL



Notched lip to easily remove from holder

Perforations promote air circulation



FC-SS



FC-SL



FC-SERIES



FC-4H with FC-PL



FC-6H with FC-PL

FLATWARE / CUTLERY CYLINDERS & HOLDERS

◆ Items FC-PL / -SS / -SL fit into 4" diameter hole

ITEM	DESCRIPTION	UOM	CASE
FC-PL	Perforated Cylinder, Plastic	Each	36/144
FC-SS	Perforated Cylinder, S/S	Each	20/80
FC-SL	Solid Cylinder, S/S	Each	20/80
FC-4H	4-Holes, 2-Tier Holder, S/S	Each	1/4
FC-6H	6-Holes, 2-Tier Holder, S/S	Each	1/2



PL-4B



SCB-4

FLATWARE / CUTLERY COMPARTMENT BINS

ITEM	DESCRIPTION	UOM	CASE
PL-4B	4 Slot Plastic Flatware Bin	Each	1/12
SCB-4	4 Slot S/S Flatware Bin	Each	1/8



OGZ-6

FLATWARE / CUTLERY ORGANIZER

◆ 2-tier, 6-bin organizer

ITEM	DESCRIPTION	UOM	CASE
OGZ-6	Organizer Bin Set	Set	1
OGZ-1B	Single Bin for OGZ-6	Each	6



PCB-8

FLATWARE / CUTLERY DISHWASHER BASKET

◆ Built-in handles for easy transport

ITEM	DESCRIPTION	SIZE	UOM	CASE
PCB-8	8 Compartment Basket	17" x 8" x 6"	Each	12

DINING ROOM MAINTENANCE



FSW-11



DP-13C



BRM-60L



ROTARY SWEEPER

◆ Manual, quiet non-electric rotary sweeper with natural bristles and steel handle

ITEM	DESCRIPTION	UOM	CASE
FSW-11	11"L x 7-3/4"W x 43"H	Each	1/4

DUST PAN WITH COVER

◆ Built-in cover for mess-free transport

ITEM	DESCRIPTION	UOM	CASE
DP-13C	13"W Pan	Set	1/10

ECONOMY FLAGGED ANGLED BROOM W/55"L HANDLE

ITEM	DESCRIPTION	UOM	CASE
BRM-60L	Flagged, 60"L Handle	Each	12

All Winco® high chairs are compliant with ASTM F404-20 standards.

HIGH CHAIRS

STACKABLE RUBBERWOOD HIGH CHAIRS

- ◆ Secure rearward stability, permanent restraint bars, active 3-point harness restraint
- ◆ Assembled size: 20-1/8"W x 19-3/8"D x 29-1/4"H; seat at 20"H

ITEM	DESCRIPTION	UOM	CASE
CHH-101	Natural, Knocked Down	Each	1
CHH-101A	Natural, Assembled	Each	1
CHH-103	Mahogany, Knocked Down	Each	1
CHH-103A	Mahogany, Assembled	Each	1
CHH-104	Walnut, Knocked Down	Each	1
CHH-104A	Walnut, Assembled	Each	1



Rearward Stability



Permanent Restraint Bars



Active 3-Point Harness



CHH-101A

CHH-103A



CHH-104A

CHH-601

WOODEN PUB-HEIGHT HIGH CHAIR

- ◆ Assembled size: 22-1/4"W x 26-3/4"D x 41"H; seat at 32"H

ITEM	DESCRIPTION	UOM	CASE
CHH-601	Natural, Knocked Down	Each	1

HIGH-CHAIR STRAPS

ITEM	DESCRIPTION	UOM	CASE
CHH-2	2 Part Replacement Seat Belt For High Chairs, Black	Each	288
CHH-4*	3 Part Replacement Seat Belt For High Chairs, Garnet	Each	12/288

*Replaces CHH-3



CHH-2

CHH-4

All Winco® booster seats are compliant with ASTM F2640-20 standards.

BOOSTER SEATS

STACKABLE RUBBERWOOD BOOSTER SEATS

- ◆ Active 3-point harness restraint
- ◆ 2 additional straps below for securing to a chair
- ◆ Booster size: 11-3/4"W x 11-3/4"D x 10-1/2"H
- ◆ Minimum chair seat requirements: 15"W x 12"D x 10"H

ITEM	DESCRIPTION	UOM	CASE
CHB-701	Natural	Each	1
CHB-703	Mahogany	Each	1
CHB-704	Walnut	Each	1



CHB-703



CHB-701



Secured to chair



CHB-704

PLASTIC BOOSTER SEATS

- ◆ Resistant to dents, breakage, rust; Dishwasher safe
- ◆ Contoured seat, high sides, wide base & non-skid surface
- ◆ Active 3-point center harness restraint
- ◆ 2 additional, adjustable straps w/ buckle secure booster to the seat and back of a chair
- ◆ Booster size: 12"W x 11-7/8"D x 9-1/4"H
- ◆ Minimum chair seat requirement: 15"W x 13"D x 12"H

ITEM	DESCRIPTION	UOM	CASE
CHB-1PK	Black	Each	1
CHB-1P	Brown	Each	1



CHB-1P



CHB-1PK

INFORMATION SIGNS



SGN-SERIES
9" X 3"

- ◆ Durable plastic construction
- ◆ Self-adhesive backing for easy mounting
- ◆ Anti-glare surface

9"W X 3"H INFORMATION SIGNS

ITEM	DESCRIPTION	COLOR	UOM	CASE
SGN-301	Push	Black	Each	12/144
SGN-302	Pull	Black	Each	12/144
SGN-303	Hand Wash Only	Black	Each	12/144
SGN-304	Private	Black	Each	12/144
SGN-305	Employees Only	Black	Each	12/144
SGN-310	No Smoking	Black	Each	12/144
SGN-311	Men	Black	Each	12/144
SGN-312	Women	Black	Each	12/144
SGN-313	Restrooms	Black	Each	12/144
SGN-317	Restroom for Customer Use Only	Black	Each	12/144
SGN-318	Wash	Black	Each	12/144
SGN-322	Employees Must Wash Hands Before Returning to Work	Black	Each	12/144
SGN-326	Caution/Watch Your Step	Black	Each	12/144
SGN-327	Rinse	Black	Each	12/144
SGN-328	Reserved	Black	Each	12/144
SGN-329	Sanitize	Black	Each	12/144
SGN-330	WiFi	Black	Each	12/144
SGN-331	No Admittance	Black	Each	12/144
SGN-332	No Pets/Shoes Shirt Required	Black	Each	12/144
SGN-333	No Food or Drink	Black	Each	12/144
SGN-334	No Cell Phone Use, Please	Black	Each	12/144
SGN-335	No E-Cigarettes	Black	Each	12/144
SGN-336	No Soliciting	Black	Each	12/144
SGN-381W	Exit	White	Each	12/144
SGN-382W	Fire Extinguisher	White	Each	12/144



SGN-SERIES
9" X 3"

9"W X 3"H INFORMATION SIGNS - SPANISH

ITEM	DESCRIPTION	COLOR	UOM	CASE
SGN-360	Employees Must Wash Hands	Black	Each	12/144
SGN-361	Employees Only	Black	Each	12/144
SGN-362	Restrooms	Black	Each	12/144
SGN-363	Wash	Black	Each	12/144
SGN-364	No Smoking	Black	Each	12/144
SGN-365	Rinse	Black	Each	12/144
SGN-366	Hand Wash Only	Black	Each	12/144
SGN-367	Sanitize	Black	Each	12/144
SGN-368	Men	Black	Each	12/144
SGN-369	Women	Black	Each	12/144



SGN-SERIES
6" X 9"

6"W X 9"H INFORMATION SIGNS

ITEM	DESCRIPTION	COLOR	UOM	CASE
SGN-601	No Smoking	Black	Each	12/72
SGN-603	Restrooms	Black	Each	12/72
SGN-651B	Women	Blue	Each	12/72
SGN-652B	Men	Blue	Each	12/72
SGN-653B	Accessible	Blue	Each	12/72
SGN-681W	Exit	White	Each	12/72
SGN-682W	Fire Extinguisher	White	Each	12/72
SGN-683W	In Case of Fire Do Not Use Elevator...	White	Each	12/72
SGN-684W	No Smoking Area	White	Each	12/72

6" W X 9" H INFORMATION SIGNS - WITH BRAILLE

ITEM	DESCRIPTION	COLOR	UOM	CASE
SGNB-607	All Gender Restroom	Black	Each	12/72
SGNB-608	All Gender Restroom w/ Accessible	Black	Each	12/72
SGNB-601	No Smoking	Black	Each	12/72
SGNB-603	Restrooms	Black	Each	12/72
SGNB-604	Exit	Black	Each	12/72
SGNB-605	Men	Black	Each	12/72
SGNB-606	Women	Black	Each	12/72
SGNB-651B	Women/Accessible	Blue	Each	12/72
SGNB-652B	Men/Accessible	Blue	Each	12/72
SGNB-653B	Accessible	Blue	Each	12/72



Tactile raised braille dots

INFORMATION SIGNS



SGNB-SERIES
6" X 9"

"SOCIAL DISTANCING" ANTI-SLIP FLOOR DECAL

Enhances awareness of social distancing standards.

- ◆ Bright yellow backdrop, bold black text, and accompanying graphic help to draw attention
- ◆ Durable construction holds up in high traffic areas
- ◆ Adhesive back allows for easy placement on floors or other smooth, solid surfaces
- ◆ 10 pieces per pack

ITEM	DESCRIPTION	UOM	CASE
PFD-12Y	12" Dia Decal	Pack	48



FLOOR DECAL



PFD-12Y



"FACE MASK REQUIRED" WINDOW CLING

Clearly inform customers of proper safety protocols.

- ◆ Clear vinyl clings to window - no adhesive required
- ◆ Removes clean & reusable to reposition as needed on smooth surfaces
- ◆ Mounts to glass from inside facing out
- ◆ 2 pieces per pack

ITEM	DESCRIPTION	UOM	CASE
WC-811	8-1/2" x 11" Cling	Pack	1/500



Adheres to inside, legible from outdoors

WINDOW CLING



WC-811



STANCHION SET



CGS-SETA

STANCHIONS & SIGN SET

Perfect for crowd control, restaurants, stores, casinos, and more.

- ◆ Great for providing directions to customers
- ◆ 8-1/2" x 11" signs fit CGSF-series stanchion frames and works with CGS-series retractable belt stanchions
- ◆ The set includes:
 - (1) Easy to read two-sided preprinted sign, "Practice Social Distancing"
 - (1) Black frame to hold the sign and easily mounts to stanchion post
 - (2) 34"H black stanchions, each with weighted base and built-in 6-1/2 ft long black retractable belt

ITEM	DESCRIPTION	UOM	CASE
CGS-SETA	Stanchion Set	Set	1



HOSTESS SIGN SET

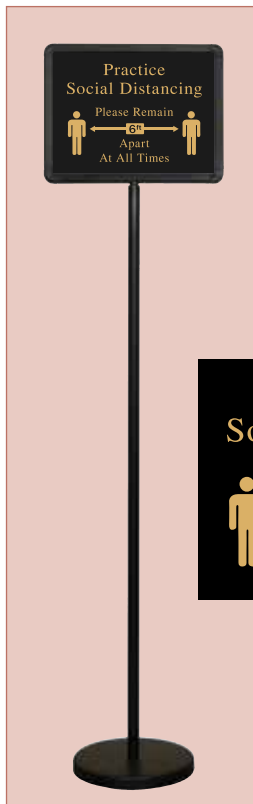

HTS-60K

Safety message included



HOSTESS SIGN SET

Complete set includes all you need to direct guests.

- ◆ 2-sided preprinted signs feature attractive gold lettering for optimum visibility
- ◆ 60" tall stand with heavy base & sturdy aluminum post
- ◆ Set includes frame, pole, base and 16 different messages

ITEM	DESCRIPTION	UOM	CASE
HTS-60K	Sign Frame w/Pole & Base	Set	1/4



Authorized Personnel Only	(blank)	Careful, Wet Floor
Meeting In Progress	No Smoking Section	Place Order Here
Please Pay Here	Please Seat Yourself	Please Wait To Be Seated
Please Watch Your Step	Section Closed	Section Reserved
Smoking In Designated Area ONLY Thank You	Smoking Section	Thank You, Please Come Again

16 different messages included

STANCHION SIGN SYSTEM

- ◆ 34" high stanchions with heavy, sturdy base and built-in 6-1/2 ft long retractable belt (overall 35-1/2"H)
- ◆ Stanchions must be purchased in multiples of two (2)

ITEM	DESCRIPTION	UOM	CASE
CGS-38K	Black Stanchion	Each	2
CGS-38S	Stainless Steel Stanchion	Each	2
CGS-WB	Wall Bracket for CGS-38K/S	Each	100
CGS-K	Plstc Head w/Black Belt for CGS-38K/S	Each	12/48
CGSF-12K	Black Frame for CGS-38K	Each	1/4
CGSF-12S	Stainless Steel Frame for CGS-38S	Each	1/4

STANCHION SIGN SYSTEM



STANCHION FRAME SIGNS

- ◆ 2-sided pre-printed signs provide maximum visibility

ITEM	DESCRIPTION	UOM	CASE
SGN-802	Please Wait To Be Seated	Each	6/36
SGN-803	Line Forms Here	Each	6/36
SGN-804	Sorry Section Closed	Each	6/36
SGN-805	Exit	Each	6/36
SGN-806	Practice Social Distancing	Each	6/36
SGN-807	Area Closed for Cleaning	Each	6/36



SGN-800 SERIES

UNIVERSAL WIPES CONTAINER STANCHION MOUNT

- ◆ Mount fits most stanchion posts & CGS-series stanchions
- ◆ Mount designed to secure the container in place
- ◆ Holder size: 5-1/2" Dia x 5-1/2" H
- ◆ Designed to hold a sanitizing wipes container

ITEM	DESCRIPTION	UOM	CASE
SMWH-5K	Holder for Wipes Container	Each	6

STANCHION MOUNTS



SMWH-5K

UNIVERSAL HAND SANITIZER & SOAP DISPENSER STANCHION MOUNT

- ◆ Mount fits most stanchion posts & CGS-series stanchions
- ◆ Accommodates most sanitizer dispensers, including automatic units
- ◆ Mount designed to secure the dispenser in place
- ◆ Mount plate size: 6-3/4"W x 16-1/2"H
- ◆ Drip tray size: 7-1/2"W x 7-1/2"D

ITEM	DESCRIPTION	UOM	CASE
SMSD-16K	Holder for Universal Sanitizer/ Soap Dispenser	Each	6



SMSD-16K

UNIVERSAL JUG STANCHION MOUNT

- ◆ Mount fits most stanchion posts & CGS-series stanchions
- ◆ Accommodates 1 gallon jugs
- ◆ Mount designed to secure the jug in place
- ◆ Holder size: 7-1/4"W x 7-1/4"D

ITEM	DESCRIPTION	UOM	CASE
SMJH-9K	Holder for 1 Gallon Jug	Each	6



SMJH-9K

LED SIGNS



LED-20

ALL-IN-ONE "OPEN" LED SIGN

Drive restaurant traffic with the one sign that says it all. Tailor this eye-catching sign to any combination of your message to broadcast your restaurant status and maximize customer attraction.

- ◆ Choose between 6 display messages
- ◆ Multiple light modes for optimal visibility
- ◆ Easy-press buttons illuminate messages individually or all together
- ◆ Bright, highly visible LED lettering grabs attention from up to 100 feet away!
- ◆ 40" chain with 18" drop to hang on wall or window
- ◆ 10ft power adaptor cord attaches to bottom of sign and plugs into any standard wall outlet
- ◆ 110-240V ~ 50/60 Hz

ITEM	DESCRIPTION	UOM	CASE
LED-20	19" x 24", English	Each	1/5
LED-21	19" x 24", Spanish	Each	1/5



Set "OPEN" to blink, scroll or remain static



40" chain with 18" drop



One-click illuminates messages individually or all together



10' power adaptor cord



LED-21



LED-6



LED-10

- ◆ Highly visible light-emitting diode/LED technology
- ◆ Lightweight; chain for hanging included
- ◆ Black adaptor with 118"L (3 meters) power cord included
- ◆ 120V ~ 60Hz

"OPEN" LED SIGNS

- ◆ LED-6: 22"L x 1-1/2"W x 13"H
- ◆ LED-10: 22-3/4"W x 1-3/4"W x 14"H

ITEM	DESCRIPTION	UOM	CASE
LED-6	Rectangle, 3 Flashing Patterns	Each	1/5
LED-10	Oval, Dust Cover, 3 Flashing Patterns	Each	1/5



LED-11

"PIZZA" LED SIGN

- ◆ LED-11: 22-3/4"L x 1-3/4"W x 14"H

ITEM	DESCRIPTION	UOM	CASE
LED-11	Oval, 3 Flashing Patterns	Each	1/5

Refer to BenchmarkUSA™ Equipment for Concessions LED signs



- ◆ High-tech Absol-Flat black glossy surface allows for easy writing
- ◆ Solid 1-1/4" wide frames with double reinforced joints

SIGN BOARDS, MARKERS, ERASER

WOODEN FRAME MARKER BOARDS

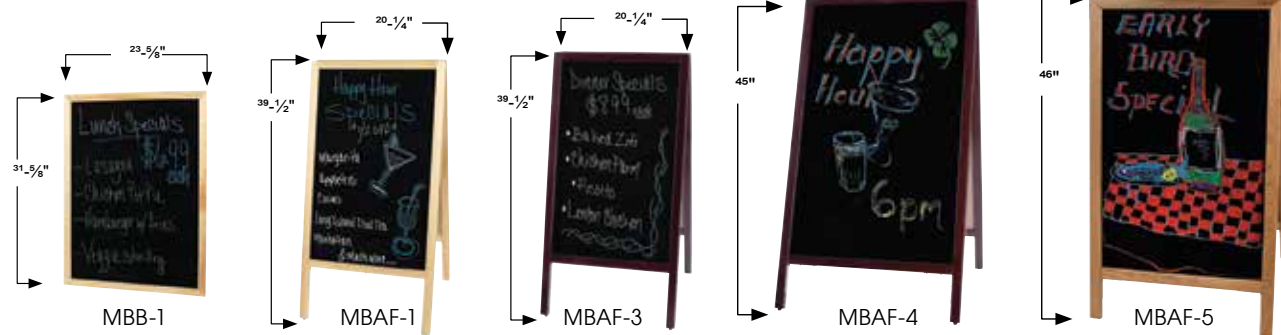

ITEM #	DESCRIPTION	INCLUDES	SIZE	UOM	CASE
MBB-1	Natural	1 Standard White Marker & Eraser	23-5/8"L x 3/4"W x 31-5/8"H	Set	6
MBB-3	Mahogany	1 Standard White Marker & Eraser	23-5/8"L x 3/4"W x 31-5/8"H	Set	1/6

DUAL-SIDED SIDEWALK A-FRAME MARKER BOARDS



ITEM #	DESCRIPTION	INCLUDES	SIZE	UOM	CASE
MBAF-1	Natural	4 Standard Markers & Eraser	20-1/4"L x 2"W x 39-1/2"H	Set	1
MBAF-3	Mahogany	4 Standard Markers & Eraser	20-1/4"L x 2"W x 39-1/2"H	Set	1
MBAF-4	Mahogany	4 Standard, 2 Deluxe Plus Markers & Eraser	25"L x 2"W x 45"H	Set	1
MBAF-5	Premium White Oak	2 Standard, 4 Deluxe Plus Markers & Eraser	26"L x 2"W x 46"H	Set	1



MBB-3 BOARD, MBBE-3 EASEL



MBBE-1

PREMIUM TRIPOD DISPLAY EASEL

- ◆ A stylish lift for the wood frame marker boards
- ◆ Solid, 1" thick wooden frame has two adjustable planes with pure copper knobs, and comes with rubber feet
- ◆ Factory assembled for superior stability

ITEM #	DESCRIPTION	SIZE	UOM	CASE
MBBE-1	Natural	23-1/4"L x 1"W x 61"H	Set	1
MBBE-3	Mahogany	23-1/4"L x 1"W x 61"H	Set	1

MARKERS & ERASER

ITEM #	DESCRIPTION	SIZE	COLOR	UOM	CASE
MBPM-B	Deluxe Plus	15g Ink, 1/16" Chisel	Neon Blue	Each	72/288
MBPM-G	Deluxe Plus	15g Ink, 1/16" Chisel	Neon Green	Each	72/288
MBPM-O	Deluxe Plus	15g Ink, 1/16" Chisel	Neon Orange	Each	72/288
MBPM-P	Deluxe Plus	15g Ink, 1/16" Chisel	Neon Pink	Each	72/288
MBPM-R	Deluxe Plus	15g Ink, 1/16" Chisel	Neon Red	Each	72/288
MBPM-U	Deluxe Plus	15g Ink, 1/16" Chisel	Neon Purple	Each	72/288
MBPM-W	Deluxe Plus	15g Ink, 1/16" Chisel	Neon White	Each	72/288
MBPM-Y	Deluxe Plus	15g Ink, 1/16" Chisel	Neon Yellow	Each	72/288
MBM-B	Standard	12g Ink, 1/4" Bullet	Neon Blue	Each	72/288
MBM-G	Standard	12g Ink, 1/4" Bullet	Neon Green	Each	72/288
MBM-P	Standard	12g Ink, 1/4" Bullet	Neon Pink	Each	72/288
MBM-R	Standard	12g Ink, 1/4" Bullet	Neon Red	Each	72/288
MBM-W	Standard	12g Ink, 1/4" Bullet	Neon White	Each	72/288
MBM-Y	Standard	12g Ink, 1/4" Bullet	Neon Yellow	Each	72/288
MB-E	Easy Wipe Eraser		Black	Each	72/288



Deluxe Plus Broad Chisel Tip Markers

Standard Bullet Tip Markers



MB-E



DELUXE PLUS SERIES



STANDARD SERIES

VIRTUOSO™ COFFEE URNS & JUICE DISPENSER

Modern design coordinates with Virtuoso chafers.

VIRTUOSO™ COFFEE URNS

- ◆ Extra-heavyweight mirror-finish stainless steel
- ◆ Available with gold-tone accents or all stainless steel
- ◆ Either 3 gallon (11.3L) or 5 gallon (18.9L) capacities



905A

905B

Coordinate with the matching Virtuoso chafers, #101 and #103-Series

ITEM	DESCRIPTION	UOM	CASE
905A	5 Gal (18.9L), Two-Tone	Set	1
905B	5 Gal (18.9L), Stainless Steel	Set	1
903A	3 Gal (11.3L), Two-Tone	Set	1
903B	3 Gal (11.3L), Stainless Steel	Set	1
FAUCET-CU	Stainless Steel Faucet	Each	1
FAUCET-JD	Plastic Faucet	Each	1



903A

903B



FAUCET-CU



FAUCET-JD



908



Cool & refreshing

VIRTUOSO™ JUICE DISPENSER WITH ICE CORE

- ◆ Break-resistant, clear plastic container provides excellent product visibility
- ◆ Mirror finish stainless steel base, core and lid
- ◆ 11-1/2"L x 13-1/2"W x 21"H
- ◆ 6-1/2" high base

ITEM	DESCRIPTION	UOM	CASE
908	3 Gal (11.3L), Mirror S/S	Set	1



Chill with ice core

PUNCH BOWL



SPB-35



STAINLESS STEEL PUNCH BOWL WITH HANDLES

- ◆ Elegantly serve a variety of spiced, fruity, fizzy punches or mocktails out of this large jorum
- ◆ Mirror finish with footed base

ITEM	DESCRIPTION	UOM	CASE
SPB-35	3-1/2 Gal (13.25L)	Each	6

- ◆ Ice core allows chilling without watering down
- ◆ Break-resistant polycarbonate containers
- ◆ Removable container and drip tray for easy cleaning

COLD BEVERAGE DISPENSERS

PEDESTAL JUICE DISPENSERS WITH ICE CORE

- ◆ Mirror finish; available with either gold-tone accents or all stainless steel details
- ◆ Break-resistant, clear plastic container provides excellent product visibility
- ◆ 10-1/8"L x 13-3/4"W x 21-1/4"H

ITEM	DESCRIPTION	UOM	CASE
901	2.2 Gal (8.3L), Two-Tone	Set	1
902	2.2 Gal (8.3L), Stainless Steel	Set	1



902

901

ACCESSORIES FOR JUICE DISPENSERS

ITEM	DESCRIPTION	UOM	CASE
901-FN	Faucet for 901, 902	Each	12/48
901-P1	Container for 901, 902	Each	4



901-P1



901-FN

COLD BEVERAGE DISPENSER WITH ICE CORE AND HANDS-FREE FAUCET

- ◆ Break-resistant, clear plastic container provides excellent product visibility
- ◆ Brushed finish stainless steel base, core and lid
- ◆ Tight-fitting lid keeps contents free from contaminants
- ◆ 9-1/8"L x 10"W x 22"H
- ◆ Detachable 8" high base

ITEM	DESCRIPTION	UOM	CASE
904	2.25 Gal (8.5L), Brushed S/S	Set	1/4
904-F	Hands-Free Faucet	Each	30

Cool & refreshing, not watered down



904-F



With
HANDS-FREE
Faucet



Fill center tube with ice to chill drinks without watering them down



904

BEVERAGE DISPENSERS



NSF PBD-3



PBD-3SK

BPA FREE PBD-SERIES

PLASTIC BEVERAGE DISPENSERS

The ideal choice when counter space is limited.

- ◆ 3 gallon (11.3L) on 8" tall base
- ◆ PBD-3 with detachable drip tray and fully removable lid
- ◆ PBD-3SK with **hands-free faucet** & hinged lid

ITEM	DESCRIPTION	UOM	CASE
PBD-3	Rectangular Dispenser, NSF	Each	1
PBD-3SK	Sq Dispenser, Hands-Free	Each	4
PBD-3-F	Faucet for PBD-3	Each	1
PBD-3SK-F	Faucet for PBD-3SK	Each	1/50
904-F	Hands-Free Faucet for PBD-3SK	Each	30



904-F



SSBD-3



SSBD-5

SLIM COLD BEVERAGE DISPENSERS

Ideal solution for narrow countertops.

- ◆ Stainless steel with a welded-on handle
- ◆ Faucet over a detachable drip tray
- ◆ Includes 3 color decals: "Iced Tea", "Lemonade" and "Iced Coffee", as well as 1 blank decal for customization

ITEM	DESCRIPTION	SIZE	UOM	CASE
SSBD-3	3 Gal (11.3L)	6-7/8"W x 13-3/4"D x 21"H	Set	1
SSBD-5	5 Gal (18.9L)	6-7/8"W x 18-7/8"D x 21-1/4"H	Set	1



3 color and 1 blank decal included

PLASTIC BEVERAGE CONTAINER & DISPENSER

- ◆ Hands-free, leak-proof faucet
- ◆ Secure snap-on lid
- ◆ Bail handle with comfortable handgrip for easy lifting
- ◆ Liter & quart gradation marks for identifying content level
- ◆ Withstands temps from -40°F (-40°C) to 160°F (71°C)
- ◆ Dishwasher safe

ITEM	DESCRIPTION	UOM	CASE
PBDW-22	6 Gallons, (22.7L) PP	Each	1/4
PBDW-HFFS	Hands-Free Faucet for PBDW-22	Each	1



PBDW-22



Fill marks



Hands-free dispensing



PBDW-HFFS

BPA FREE PBDW-SERIES



New Item

AIRPOTS

Keep beverages hotter longer. Double-wall insulation protects from damage and retains heat for an extended length of time.

- ◆ Swivel base for easy access
- ◆ Double-wall insulated
- ◆ Stainless steel satin-finish body
- ◆ Includes four (4) "Lift & Twist" color tags for **Coffee, Decaf, Tea & Hot water**

STAINLESS STEEL LINED AIRPOTS

- ◆ Heat retention: 10 hours at 175°F / 24 hours at 151°F

ITEM	DESCRIPTION	UOM	CASE
APSK-725	2.5L Lever Top	Each	1/6
APSK-730	3L Lever Top	Each	1/6
APSP-925	2.5L Push Button	Each	1/6
APSP-930	3L Push Button	Each	1/6



GLASS LINED AIRPOTS

- ◆ Heat retention: 10 hours at 171°F / 24 hours at 147°F

ITEM	DESCRIPTION	UOM	CASE
AP-522	2.2L Push Button	Each	1/6
AP-525	2.5L Push Button	Each	1/6
AP-535	3L Push Button	Each	1/6
AP-819	1.9L Lever Top	Each	1/6
AP-822	2.2L Lever Top	Each	1/6
AP-825	2.5L Lever Top	Each	1/6
AP-835	3L Lever Top	Each	1/6



AIRPOT REPLACEMENT LIDS

- ◆ Lids fit APSK-, APSP-, and AP-Series airpots

ITEM	DESCRIPTION	UOM	CASE
AP-LTW	Lever-Top Lid	Each	50
AP-PTW	Push-Button Lid	Each	48



WIRE AIRPOT RACK

Ideal for countertop self-service. Economize on space and keep service areas tidy.

- ◆ Sturdy 1/4" thick heavy-duty black coated wire construction resists bending or breaking
- ◆ Removable stainless steel drip trays for easy cleanup
- ◆ Includes a sign holder to identify contents or branding
- ◆ Fits Winco® APSK-, APSP-, and AP-Series airpots

Set Includes:

- ◆ 2 Wire Racks
- ◆ 2 Drip Trays
- ◆ 2 Sign Holder
- ◆ 2 Legs
- ◆ Cross Brace
- ◆ Support Bars

ITEM	DESCRIPTION	UOM	CASE
APRK-6	Two Level Rack, Holds 6 Airpots	Set	1/2



GRAVITY BEVERAGE DISPENSER



SBD-1.5

1.5 GALLON GRAVITY BEVERAGE DISPENSER WITH SIGHT GLASS & BREW-THROUGH LID

- ◆ Patented structure allows the body to detach from stand
- ◆ Tomlinson® faucet with protection guard
- ◆ Brew directly into dispenser with brew-through lid
- ◆ Double-wall vacuum insulated
- ◆ Retains heat for 4 to 6 hours
- ◆ Sturdy plastic handle for easy lifting and carrying
- ◆ Satin-finish stainless steel
- ◆ 16"L x 11-1/2"W x 25-3/8"H

ITEM	DESCRIPTION	UOM	CASE
SBD-1.5	1.5 Gal Dispenser	Each	1/1

STAINLESS STEEL BEVERAGE SIGNS



SGN-SERIES TENT SIGNS

STAINLESS STEEL STANDING TENT SIGNS

Compact size, ideal for tabletops.

- ◆ 3"L x 1-1/2"D x 1-1/4"H
- ◆ Highly visible bold lettering

ITEM	DESCRIPTION	UOM	CASE
SGN-100	Blank Sign	Each	12/120
SGN-101	Hot Tea	Each	12/120
SGN-102	Decaf	Each	12/120
SGN-103	Coffee	Each	12/120
SGN-104	Hot Water	Each	12/120
SGN-105	Iced Tea	Each	12/120

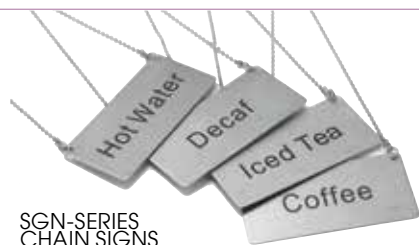

SGN-SERIES CHAIN SIGNS

HANGING CHAIN SIGNS

- ◆ 3-1/2"L x 1-3/4"W sign with 12" long chain

ITEM	DESCRIPTION	UOM	CASE
SGN-202	Decaf	Each	12/120
SGN-203	Coffee	Each	12/120
SGN-204	Hot Water	Each	12/120
SGN-205	Iced Tea	Each	12/120

DRIP TRAYS

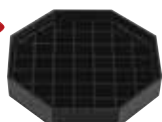

CR-1451B



Place beneath beverage dispenser faucets to catch and collect drips, minimizing mess.

- ◆ Removable grid for easy cleaning
- ◆ Dishwasher safe

BAR MAID® DRIP TRAYS

ITEM	DESCRIPTION	UOM	CASE
CR-1451B	4-1/2" Tray	Each	12/144
CR-1440	6" Tray	Each	12/72



DT-45



DT-60



DT-SERIES



DRIP TRAYS

ITEM	DESCRIPTION	UOM	CASE
DT-45	4-1/2" Tray, 4 pcs/pk	Pack	12/24
DT-60	6" Tray, 4 pcs/pk	Pack	12/24

INSULATED SERVERS

PLASTIC SWIRL BEVERAGE SERVERS

- ◆ Hot beverages, stylish presentation, & ease of use in one
- ◆ Double-wall insulated with durable plastic body
- ◆ Press-tab on lid
- ◆ Includes colored tags for differentiating contents

ITEM	DESCRIPTION	COLOR	UOM	CASE
VSW-20W	20 Oz Server	White	Each	1/24
VSW-42W	42 Oz Server	White	Each	1/12
VSW-64W	64 Oz Server	White	Each	1/6
VSW-20K	20 Oz Server	Black	Each	1/24
VSW-42K	42 Oz Server	Black	Each	1/12
VSW-64K	64 Oz Server	Black	Each	1/6



Colored I.D. tags included

Clips onto handle



VSW-64K



VSW-64W

VSW-SERIES NSF

STAINLESS STEEL LINED SATIN FINISH SERVER

- ◆ Double-wall insulated
- ◆ Attractive slim profile in satin finish with mirror accents
- ◆ Hinged lid and large pour spout
- ◆ Wide handle for secure grip
- ◆ 4-3/4"L x 4"W x 8-1/4"H

ITEM	DESCRIPTION	UOM	CASE
VSS-508	20 Oz Server	Each	12



VSS-508

STAINLESS STEEL LINED SATIN FINISH CARAFES

- ◆ Heat retention: 6 hours at 171°F / 24 hours at 121°F
- ◆ Double-wall insulated
- ◆ Includes colored bands for differentiating contents

ITEM	DESCRIPTION	UOM	CASE
CF-1.2	40 Oz (1.2L) Carafe	Each	1/8
CF-1.5	50 Oz (1.5L) Carafe	Each	1/8
CF-2.0	68 Oz (2L) Carafe	Each	1/8
CF-LID	Lid for CF-1.2/1.5/2.0	Each	24/96



Colored bands included

Flexible to slide onto handle



CF-2.0



CF-1.5



CF-1.2

STAINLESS STEEL LINED COFFEE/CREAM SERVERS

- ◆ Double-wall insulated

ITEM	DESCRIPTION	UOM	CASE
VSS-24	24 Oz Server	Each	12
VSS-33	33 Oz Server	Each	12



VSS-24



VSS-33

STAINLESS STEEL PITCHERS



WPB-2H



WPB-2CH



HAMMERED BELL PITCHERS

ITEM	DESCRIPTION	UOM	CASE
WPB-2H	2 Qt	Each	1/24
WPB-2CH	2 Qt w/Ice Guard	Each	1/24
WPB-3H	3 Qt	Each	1/24
WPB-3CH	3 Qt w/Ice Guard	Each	1/24



WPB-2



WPB-2C

DELUXE BELL PITCHERS

ITEM	DESCRIPTION	UOM	CASE
WPB-2	2 Qt	Each	1/24
WPB-2C	2 Qt w/Ice Guard	Each	1/24
WPB-3	3 Qt	Each	1/24
WPB-3C	3 Qt w/Ice Guard	Each	1/24



BS-64



WPG-64

CLASSIC COFFEE & WATER SERVERS

ITEM	DESCRIPTION	UOM	CASE
BS-64	64 Oz Coffee Server	Each	1/12
WPG-64	64 Oz Water Pitcher with Ice Guard	Each	1/12



True
28 ounce
capacity

JB2928



GS-10



W632



GOOSENECK TEAPOTS & CREAMER

ITEM	DESCRIPTION	UOM	CASE
JB2920	20 Oz Teapot	Each	1/24
JB2928	28 Oz Teapot	Each	1/24
JB2932	32 Oz Teapot	Each	1/24
GS-10	10 Oz Creamer	Each	1/36



SHORT SPOUT BEVERAGE SERVERS

ITEM	DESCRIPTION	UOM	CASE
W612	12 Oz	Each	1/50
W632	32 Oz	Each	1/50
W670	70 Oz	Each	1/30

TEAPOT & ACCESSORIES



GTP-25



25 OZ GLASS TEAPOT WITH INFUSER BASKET

- ◆ Fine mesh stainless steel removable strainer
- ◆ Glass carafe cradled in plastic body, suitable for loose tea brewing

ITEM	DESCRIPTION	UOM	CASE
GTP-25	25 Oz, 6"L x 4-3/4"W x 5-1/2"H	Each	1/48



GHT-10



GHT-10C



STB-7

GLASS HOTTLE

- ◆ Non-slip, heat-resistant plastic grip; includes plastic lid
- ◆ Can also be used to steep tea
- ◆ Dishwasher safe

ITEM	DESCRIPTION	UOM	CASE
GHT-10	10 Oz	Each	12/24
GHT-10C	Replacement Lid for GHT-10	Each	12/600

STAINLESS STEEL TEA INFUSER BALL

ITEM	DESCRIPTION	UOM	CASE
STB-5	2"	Each	40/240
STB-7	3"	Each	40/240

BREAK-RESISTANT SAN-PLASTIC WATER PITCHERS

ITEM	DESCRIPTION	UOM	CASE
WPS-32	32 Oz, 4-Pcs/Pk	Pack	12
WPS-60	60 Oz, 4-Pcs/Pk	Pack	8

WATER PITCHER WITH ICE TUBE

ITEM	DESCRIPTION	UOM	CASE
WPIT-19	64 Oz, PC	Each	1/12

THREE-SPOUT AMBER OR CLEAR WATER PITCHERS

ITEM	DESCRIPTION	UOM	CASE
WPCT-60A	60 Oz, Amber, PC	Each	12
WPCT-60C	60 Oz, Clear, PC	Each	12

SINGLE SPOUT CLEAR WATER PITCHERS

ITEM	DESCRIPTION	UOM	CASE
WPC-32	32 Oz, PC	Each	1/12
WPC-48	48 Oz, PC	Each	12
WPC-60	60 Oz, PC	Each	1/12

BEER PITCHER

ITEM	DESCRIPTION	UOM	CASE
WPCB-60	60 Oz, PC	Each	12

DECANTERS WITH FLIP-TOP LIDS

ITEM	DESCRIPTION	UOM	CASE
PDT-05	0.5 Qt, PC	Each	24
PDT-10	1 Qt, PC	Each	24
PDT-15	1.6 Qt, PC	Each	24

PLASTIC PITCHERS



BREAK-RESISTANT SAN-PLASTIC HAVANA TUMBLERS

◆ Commercial dishwasher safe

ITEM	DESCRIPTION	CAPACITY	UOM	CASE
PTSN-9	Blue	9 Oz	Doz	6
PTSN-12	Blue	12 Oz	Doz	6
PTSN-16	Blue	16 Oz	Doz	4

PEBBLED TUMBLERS

ITEM	DESCRIPTION	CAPACITY	UOM	CASE
PTP-05A	Amber	5 Oz	Doz	6
PTP-05B	Blue	5 Oz	Doz	6
PTP-05C	Clear	5 Oz	Doz	6
PTP-05R	Red	5 Oz	Doz	6
PTP-08A	Amber	8 Oz	Doz	6
PTP-08B	Blue	8 Oz	Doz	6
PTP-08C	Clear	8 Oz	Doz	6
PTP-08R	Red	8 Oz	Doz	6
PTP-09A	Amber	9-1/2 Oz	Doz	6
PTP-09B	Blue	9-1/2 Oz	Doz	6
PTP-09C	Clear	9-1/2 Oz	Doz	6
PTP-09R	Red	9-1/2 Oz	Doz	6
PTP-12A	Amber	12 Oz	Doz	6
PTP-12B	Blue	12 Oz	Doz	6
PTP-12C	Clear	12 Oz	Doz	6
PTP-12R	Red	12 Oz	Doz	6
PTP-16A	Amber	16 Oz	Doz	6
PTP-16B	Blue	16 Oz	Doz	6
PTP-16C	Clear	16 Oz	Doz	6
PTP-16R	Red	16 Oz	Doz	6
PTP-20A	Amber	20 Oz	Doz	2
PTP-20B	Blue	20 Oz	Doz	2
PTP-20C	Clear	20 Oz	Doz	2
PTP-20R	Red	20 Oz	Doz	2
PTP-24A	Amber	24 Oz	Doz	2
PTP-24B	Blue	24 Oz	Doz	2
PTP-24C	Clear	24 Oz	Doz	2
PTP-24R	Red	24 Oz	Doz	2
PTP-32A	Amber	32 Oz	Doz	2
PTP-32B	Blue	32 Oz	Doz	2
PTP-32C	Clear	32 Oz	Doz	2
PTP-32R	Red	32 Oz	Doz	2

PLASTIC DRINKWARE



COFFEE SERVICE



Cadenza™

Monte Carlo™

Sleek and sophisticated, the Monte Carlo™ holloware line features clean and fluid contours in brilliant 18/10 stainless steel mirror finish that is striking in all cosmopolitan dining environments.

ITEM	DESCRIPTION	UOM	CASE
Z-MC-C05	Monte Carlo Creamer, 5 oz, 0.2 lbs	Each	6/72
Z-MC-TP10	Monte Carlo Tea Pot, 10 oz, 0.4 lbs	Each	6/72
Z-MC-CP64	Monte Carlo Coffee Server, 64 oz, 1.2 lbs	Each	6/12
Z-MC-WP64	Monte Carlo Water Pitcher (Ice Guard), 64 oz, 1.6 lbs	Each	6/12

COFFEE ACCESSORIES



18/8 STAINLESS STEEL COFFEE SCOOP

- ◆ Measures 1 tablespoon; long handle for easy reach
- ◆ Fingerprint-resistant satin finish



CSP-6

ITEM	DESCRIPTION	UOM	CASE
CSP-6	6" L	Each	12/288



WP-66



CD-64



STAINLESS STEEL FROTHING PITCHERS

ITEM	DESCRIPTION	UOM	CASE
WP-14	11 Oz	Each	1/48
WP-20	20 Oz	Each	1/48
WP-33	33 Oz	Each	1/36
WP-50	50 Oz	Each	1/24
WP-66	66 Oz	Each	1/24

STAINLESS STEEL COFFEE SERVER WITH LID

ITEM	DESCRIPTION	UOM	CASE
CD-64	64 Oz w/Lid	Each	1/12



CDB-11

DECANTER CLEANING BRUSHES

ITEM	DESCRIPTION	UOM	CASE
CDB-11	Decanter Brush, 11"L x 1-1/4"W x 1-1/4"H	Each	12/96
BR-25	Equipment Brush, 25"	Each	12/96



BR-25

GLASS COFFEE DECANTERS WITH STAINLESS STEEL BASE COFFEE ACCESSORIES

ITEM	DESCRIPTION	UOM	CASE
CD-64K	64 Oz Regular, Black	Each	1/24
CD-64O	64 Oz Decaf, Orange	Each	1/24

Use decanters with coffee machines **ONLY**



SCD-5

CD-64O

CD-64K

STAINLESS STEEL COFFEE DREDGE KNOCK BOX

- ◆ 23 gauge; fits any 1/6th size opening

ITEM	DESCRIPTION	UOM	CASE
SCD-5	7"L x 6"W x 5"H	Each	1/24

ONE-AT-A-TIME IN-COUNTER CUP DISPENSER

Spring-loaded design allows for one-at-a-time dispensing in horizontal, angled or vertical mounting positions.

- ◆ Made of durable ABS plastic
- ◆ Designed for cups with rim diameters from 3-1/8" to 4-1/2"
- ◆ Built-in clips allow adjustment without removing dispenser from where it is mounted

ITEM	DESCRIPTION	UOM	CASE
CDIC-4	24"L x 5-1/4"Dia	Each	1/9

CUP DISPENSER, RACKS & ORGANIZERS



CDIC-4

ONE-AT-A-TIME CUP DISPENSING RACKS

- ◆ Load from front or back - dispenses one at a time
- ◆ Suction feet securely hold dispenser on a flat surface
- ◆ For cups from 8 oz to 44 oz with rims between 3-1/8" and 4" diameter

ITEM	DESCRIPTION	UOM	CASE
CDR-3	3-Tier	Each	1/2
CDR-4	4-Tier	Each	1/2

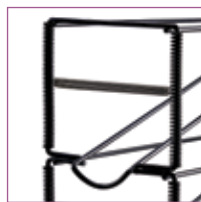

Modify for different cup sizes by adjusting the twist springs

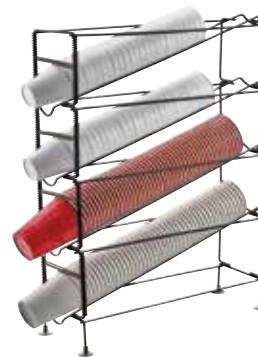

CDR-4
20"L X 6-1/4"W X 24-3/4"H



CDR-3
20"L X 6-1/4"W X 19-1/4"H

CUP & LID ABS-PLASTIC ORGANIZERS

ITEM	DESCRIPTION	UOM	CASE
CLO-2D	2 Tiers & 2 Stacks	Each	1/4
CLO-3D	2 Tiers & 3 Stacks	Each	1/4
CLSO-2T	3 Tiers & 2 Stacks	Each	1/4
CLSO-3T	3 Tiers & 3 Stacks	Each	1/4



CLSO-3T
12-5/16"L x 12-3/4"W x 13-1/8"H



CLSO-2T
8-1/2"L x 13-1/16"W x 12-3/16"H



CLO-3D
12-11/16"L x 8-5/8"W x 12-1/4"H



CLO-2D
8-1/2"L x 8-5/8"W x 12-1/4"H

DISPLAY TRAYS & BOWLS



1/8" STAINLESS STEEL DISPLAY TRAYS

ITEM	DESCRIPTION	SIZE (L X W X H)	UOM	CASE
HPS-10	Square	10-1/4" x 10-1/4" x 5/8"	Each	12
HPR-8	Round	8-7/8" Dia x 1-5/8"	Each	12
HPR-9	Round	9-5/8" Dia x 1-5/8"	Each	12
HPR-10	Round	10-1/4" Dia x 1-5/8"	Each	12

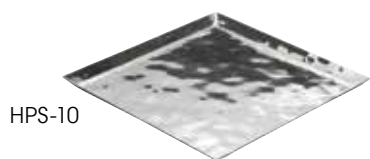

HPS-10



HPR-10

Inclined to entertain



STAINLESS STEEL DOUBLE-WALL ANGLED DISPLAY BOWLS

- ◆ Maintains serving temperature
- ◆ Does not sweat or bead
- ◆ Indentations for standing flat or at an angle
- ◆ Satin interior disguises scratches

ITEM	DESCRIPTION	UOM	CASE
DWAB-S	1-1/2 Qt	Each	1/12
DWAB-L	2-1/4 Qt	Each	1/6



DWAB-S



DWAB-L

PEARLIZED LIGHTWEIGHT ABS-PLASTIC SHELL BOWLS

ITEM	DESCRIPTION	UOM	CASE
PSBW-1W	20 Oz Bowl	Each	12/48
PSBW-5W	5 Qt Bowl	Each	6/12



PSBW-1W



PSBW-5W

PEBBLED POLYCARBONATE SALAD BOWLS

ITEM	DESCRIPTION	UOM	CASE
PBB-6	6-3/4" Bowl	Each	96
PBB-8	8-3/4" Bowl	Each	48
PBB-10	10-3/4" Bowl	Each	24
PBB-12	12-3/4" Bowl	Each	24
PBB-15	15-3/4" Bowl	Each	12
PBB-18	18-3/4" Bowl	Each	12



PBB-10



PBB-SERIES

Improved

TEXTURED ACRYLIC DISPLAY TRAYS

- ◆ Trays fit in ADC-Series acrylic display cases and under dome covers

ITEM	DESCRIPTION	SIZE (L X W)	UOM	CASE
AST-3G	Gold-Tone Acrylic Tray	20-3/4" x 12-3/4"	Each	24
AST-3S	Silver-Tone Acrylic Tray	20-3/4" x 12-3/4"	Each	24

Replaces AST-2G and AST-1S



AST-3G



AST-3S



ALUMINUM SEAFOOD TRAYS

Create an enticing display of shrimp, seafood or tasty appetizers with assorted size trays.

- ◆ Aluminum retains cold to keep food at safe serving temperatures
- ◆ Brushed finish disguises scratches for optimal presentation

ITEM	DESCRIPTION	UOM	CASE
ASFT-12	12"Dia x 1-1/2"H	Each	12/36
ASFT-14	13-3/4"Dia x 1-1/2"H	Each	12/36
ASFT-16	15-3/4"Dia x 1-1/2"H	Each	12/24
ASFT-18	17-3/4"Dia x 1-1/2"H	Each	12/24
ASFT-20	19-3/4"Dia x 1-1/2"H	Each	12

DISPLAY RISERS, TRAYS, BOWLS



ASFT-12

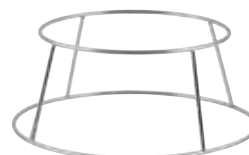

SFR-4

CHROME-PLATED SEAFOOD TRAY DISPLAY RACKS

- ◆ Compatible with ASFT-series trays; also ideal for elevating pizza pans for tabletop presentation

ITEM	DESCRIPTION	UOM	CASE
SFR-4	7-3/8" Top Dia, 9-5/8" Bottom Dia x 4-3/8"H	Each	20
SFR-7	7-3/8" Top Dia, 9-5/8" Bottom Dia x 7"H	Each	20

SAN-PLASTIC DELI/DISPLAY CROCKS

ITEM	DESCRIPTION	COLOR	UOM	CASE
CRK-10R	10" x 7" x 3"	Red	Each	24
CRK-10K	10" x 7" x 3"	Black	Each	24
CRK-10C	10" x 7" x 3"	Clear	Each	24
CRK-10W	10" x 7" x 3"	White	Each	24
CRK-13R	13" x 10" x 3"	Red	Each	12
CRK-13K	13" x 10" x 3"	Black	Each	12
CRK-13C	13" x 10" x 3"	Clear	Each	12
CRK-13W	13" x 10" x 3"	White	Each	12



DISPLAY CROCKS



CRK-SERIES



CRKC-13

CRKC-10

COVERS FOR DELI/DISPLAY CROCKS

ITEM	DESCRIPTION	COLOR	UOM	CASE
CRKC-10	Cover for CRK-10 Series	Clear	Each	48
CRKC-13	Cover for CRK-13 Series	Clear	Each	48

WOVEN DISPLAY BASKETS WITH HANDLES

ITEM	DESCRIPTION	UOM	CASE
PWBN-12B	12"L x 8"W x 3"H	Each	12/96
PWBN-16B	16"L x 11"W x 3"H	Each	12/48



WOVEN DISPLAY BASKET



PWBN-16B

ACRYLIC & PLASTIC DISPLAYS



C-DP1



C-DPF1



C-DPF2



POLYCARBONATE PLASTIC DOME COVERS

- ◆ Full-size dome can be used with AST-1S and AST-1G trays
- ◆ C-DP1 & C-DPF1 fits full-size steam table pans and poly pans
- ◆ C-DP2 & C-DPF2 fits half-size steam table and poly pans

ITEM	DESCRIPTION	SIZE (L X W)	UOM	CASE
C-DP1	Full-size Cover	21-1/2" x 13-3/4"	Each	12
C-DP2	Half-size Cover	13-1/2" x 11"	Each	24
C-DPF1	Full-size Flip Cover	21-1/2" x 13-3/4"	Each	12
C-DPF2	Half-size Cut-out Cover	13-1/2" x 11"	Each	24

NSF DOME COVERS



POLYCARBONATE HINGED DOME COVER

- ◆ Fits full-size steam table pans and poly pans

ITEM	DESCRIPTION	SIZE (L X W X H)	UOM	CASE
C-DPFH	Full-size Hinged Cover	21" x 13"	Each	12

NSF C-DPFH



ACN-4



ACRYLIC ICE CREAM CONE HOLDER

- ◆ Holds 4 cones

ITEM	DESCRIPTION	SIZE (L X W X H)	UOM	CASE
ACN-4	4-Hole Stand	12" x 4" x 4-1/2"	Each	1/12

ROLL-TOP COVER



C-RCF

18/8 STAINLESS STEEL ROLL-TOP COVER

- ◆ Fits full-size 12" x 20" opening food pan
- ◆ Plastic handle is heat resistant up to 220°F (105°C)
- ◆ Can be used over standard sized food warmers/cookers

ITEM	DESCRIPTION	UOM	CASE
C-RCF	20-3/4"L x 13"W x 11-7/8"H	Each	1/2



Open



Closed on a food pan



Open on a food pan

ANGLED ADAPTOR



ADB-4

ANGLED DISPLAY ADAPTOR

Lift steam table pans for better view and easy access to selections.

ITEM	DESCRIPTION	UOM	CASE
ADB-4	Full-size, S/S	Each	2/6

CAKE STAND & COVER

- ◆ Attractive display for cakes, pastries, and more
- ◆ Break-resistant plastic cover provides protection and a clear view of decorated desserts
- ◆ Stand: 13" diameter x 6" high
- ◆ Cover: 12" diameter x 7-1/2" high
- ◆ Cover available for full case purchase only

ITEM	DESCRIPTION	UOM	CASE
CKS-13	13"Dia Stand, S/S	Set	6/12
CKS-13C	12"Dia Cover, Plastic, NSF	Each	6





CKS-13

CKS-13C, COVER 

ACRYLIC TIERED DISPLAY CASES

Optimize counter space and increase impulse purchases with clear-view vertical cases.

- ◆ Trays fit into tracks that are angled up for a better view
- ◆ Easily slide trays out for cleaning and restocking
- ◆ Restock through operator doors on back; front door allows for customer self-service
- ◆ Durable and easy to wipe clean

ITEM	DESCRIPTION	SIZE (L X W X H)	UOM	CASE
 ADC-2	2-Tray, Front & Rear Door	21" x 18" x 12"	Set	1
 ADC-3	3-Tray, Rear Door	21" x 18" x 16-1/2"	Set	1
 ADC-4	4-Tray, Front & Rear Door	14" x 24" x 24"	Set	1
ADC-TY	Tray for ADC-Series Display Cases	20-1/4" x 13-1/4" x 3/4"	Each	12



ADC-2 & ADC-4 feature handle on front for self-serve option



Trays fit into tracks that are angled up for a better view

TIERED DISPLAY CASES



ADC-2



ADC-3



ADC-4

SIGN BOARDS, MARKERS, ERASER

- ◆ High-tech Absol-Flat black glossy surface allows for easy writing
- ◆ Solid 1-1/4" wide frames with double reinforced joints

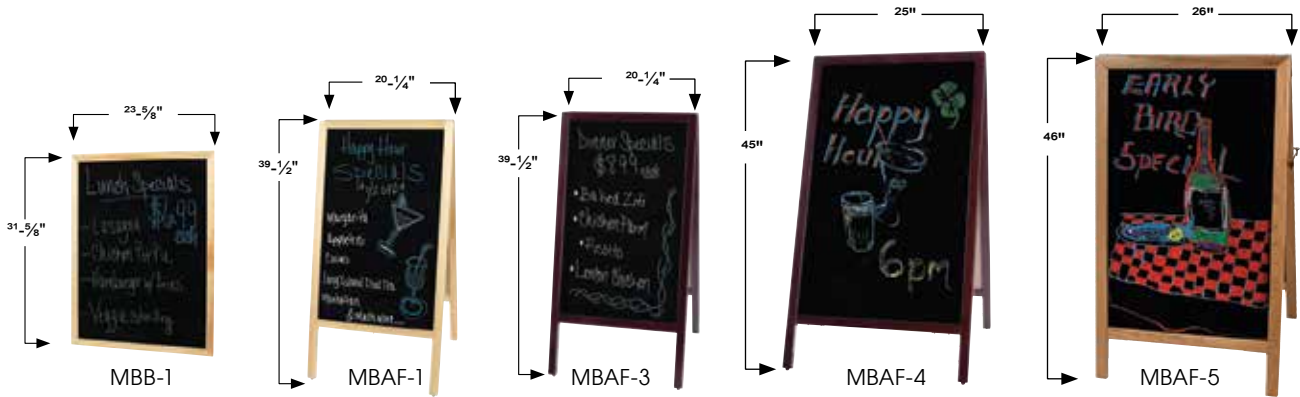

WOODEN FRAME MARKER BOARDS

ITEM #	DESCRIPTION	INCLUDES	SIZE (L X W X H)	UOM	CASE
MBB-1	Natural	1 Standard White Marker & Eraser	23-5/8" x 3/4" x 31-5/8"	Set	6
MBB-3	Mahogany	1 Standard White Marker & Eraser	23-5/8" x 3/4" x 31-5/8"	Set	1/6



MBB-3 BOARD, MBBE-3 EASEL



MBAF-1

DUAL-SIDED SIDEWALK A-FRAME MARKER BOARDS

ITEM #	DESCRIPTION	INCLUDES	SIZE (L X W X H)	UOM	CASE
MBAF-1	Natural	4 Standard Markers & Eraser	20-1/4" x 2" x 39-1/2"	Set	1
MBAF-3	Mahogany	4 Standard Markers & Eraser	20-1/4" x 2" x 39-1/2"	Set	1
MBAF-4	Mahogany	4 Standard, 2 Deluxe Plus Markers & Eraser	25" x 2" x 45"	Set	1
MBAF-5	Premium White Oak	2 Standard, 4 Deluxe Plus Markers & Eraser	26" x 2" x 46"	Set	1

PREMIUM TRIPOD DISPLAY EASEL

- ◆ A stylish lift for the wood frame marker boards
- ◆ Solid, 1" thick wooden frame has two adjustable planes with pure copper knobs, and comes with rubber feet
- ◆ Factory assembled for superior stability

ITEM #	DESCRIPTION	SIZE (L X W X H)	UOM	CASE
MBBE-1	Natural	23-1/4" x 1" x 61"	Set	1
MBBE-3	Mahogany	23-1/4" x 1" x 61"	Set	1

MARKERS & ERASER



Deluxe Plus Broad Chisel Tip Markers

Standard Bullet Tip Markers



MB-E

ITEM #	DESCRIPTION	SIZE	COLOR	UOM	CASE
MBPM-B	Deluxe Plus	15g Ink, 1/16" Chisel	Neon Blue	Each	72/288
MBPM-G	Deluxe Plus	15g Ink, 1/16" Chisel	Neon Green	Each	72/288
MBPM-O	Deluxe Plus	15g Ink, 1/16" Chisel	Neon Orange	Each	72/288
MBPM-P	Deluxe Plus	15g Ink, 1/16" Chisel	Neon Pink	Each	72/288
MBPM-R	Deluxe Plus	15g Ink, 1/16" Chisel	Neon Red	Each	72/288
MBPM-U	Deluxe Plus	15g Ink, 1/16" Chisel	Neon Purple	Each	72/288
MBPM-W	Deluxe Plus	15g Ink, 1/16" Chisel	Neon White	Each	72/288
MBPM-Y	Deluxe Plus	15g Ink, 1/16" Chisel	Neon Yellow	Each	72/288
MBM-B	Standard	12g Ink, 1/4" Bullet	Neon Blue	Each	72/288
MBM-G	Standard	12g Ink, 1/4" Bullet	Neon Green	Each	72/288
MBM-P	Standard	12g Ink, 1/4" Bullet	Neon Pink	Each	72/288
MBM-R	Standard	12g Ink, 1/4" Bullet	Neon Red	Each	72/288
MBM-W	Standard	12g Ink, 1/4" Bullet	Neon White	Each	72/288
MBM-Y	Standard	12g Ink, 1/4" Bullet	Neon Yellow	Each	72/288
MB-E	Easy Wipe Eraser		Black	Each	72/288



DELUXE PLUS SERIES

STANDARD SERIES



Shake and Stir with Style



*10 piece line
in 2 finishes:*
Antique Copper
Crafted Steel



Crafted Steel



BAJ-7CS BAJ-8CS BAJ-9CS

18/8 STAINLESS STEEL JIGGERS

- ◆ Japanese style, tall shape for an easy, smooth pour
- ◆ Easily identify capacity by the markings on each side
- ◆ Inner fractional marks add flexibility

ITEM	DESCRIPTION	UOM	CASE
BAJ-7CS	Jigger, 1/2oz, 3/4oz	Each	120
BAJ-8CS	Jigger, 1oz, 1-1/2oz	Each	120
BAJ-9CS	Jigger, 1oz, 2oz	Each	120



BASK-20CS BASK-28CS

18/8 STAINLESS STEEL SHAKER CUPS

- ◆ Weighted, sturdy base
- ◆ Satin-finish interior disguises scratches
- ◆ Small and large cups fit together for shaking
- ◆ 20oz and 28oz capacities

ITEM	DESCRIPTION	UOM	CASE
BASK-20CS	Shaker Cup, 20oz	Each	48
BASK-28CS	Shaker Cup, 28oz	Each	48



BASS-16CS BASS-24CS

18/8 STAINLESS STEEL SHAKER SETS

- ◆ Shaker cup with built-in strainer and cap
- ◆ Satin-finish interior disguises scratches
- ◆ 16oz and 24oz capacities

ITEM	DESCRIPTION	UOM	CASE
BASS-16CS	Shaker Set, 16oz	Each	48
BASS-24CS	Shaker Set, 24oz	Each	48



BABS-6CS

BAJS-6CS

18/8 STAINLESS STEEL STRAINERS

- ◆ Coiled spring and precision holes effectively strain & drain
- ◆ 4 prongs add stability on different pouring vessels, and built-in finger tab assists grip when straining

ITEM	DESCRIPTION	UOM	CASE
BABS-6CS	4-Prong Strainer	Each	120
BAJS-6CS	Julep Strainer	Each	120



BABS-12CS

18/8 STAINLESS STEEL 12" BAR SPOON

- ◆ Weighted teardrop end for balanced stir
- ◆ Spiral stem assists with grip and mixing technique

ITEM	DESCRIPTION	UOM	CASE
BABS-12CS	Bar Spoon, 12"L	Each	120

Antique Copper

18/8 STAINLESS STEEL JIGGERS

- ◆ Japanese style, tall shape for an easy, smooth pour
- ◆ Easily identify capacity by the markings on each side
- ◆ Inner fractional marks add flexibility

ITEM	DESCRIPTION	UOM	CASE
BAJ-7AC	Jigger, 1/2oz, 3/4oz	Each	120
BAJ-8AC	Jigger, 1oz, 1-1/2oz	Each	120
BAJ-9AC	Jigger, 1oz, 2oz	Each	120



BAJ-9AC BAJ-8AC BAJ-7AC

18/8 STAINLESS STEEL SHAKER CUPS

- ◆ Weighted, sturdy base
- ◆ Satin-finish interior disguises scratches
- ◆ Small and large cups fit together for shaking
- ◆ 20oz and 28oz capacities

ITEM	DESCRIPTION	UOM	CASE
BASK-20AC	Shaker Cup, 20oz	Each	48
BASK-28AC	Shaker Cup, 28oz	Each	48



BASK-28AC BASK-20AC

18/8 STAINLESS STEEL SHAKER SETS

- ◆ Shaker cup with built-in strainer and cap
- ◆ Satin-finish interior disguises scratches
- ◆ 16oz and 24oz capacities

ITEM	DESCRIPTION	UOM	CASE
BASS-16AC	Shaker Set, 16oz	Each	48
BASS-24AC	Shaker Set, 24oz	Each	48



BASS-24AC BASS-16AC



All pieces in retail packaging

18/8 STAINLESS STEEL STRAINERS

- ◆ Coiled spring and precision holes effectively strain & drain
- ◆ 4 prongs add stability on different pouring vessels, and built-in finger tab assists grip when straining

ITEM	DESCRIPTION	UOM	CASE
BABS-6AC	4-Prong Strainer	Each	120
BAJS-6AC	Julep Strainer	Each	120

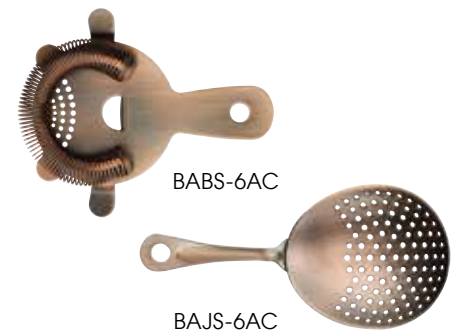

BABS-6AC
BAJS-6AC

18/8 STAINLESS STEEL 12" BAR SPOON

- ◆ Weighted teardrop end for balanced stir
- ◆ Spiral stem assists with grip and mixing technique

ITEM	DESCRIPTION	UOM	CASE
BABS-12AC	Bar Spoon, 12"L	Each	120

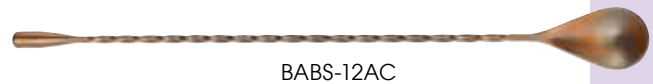

BABS-12AC

DRINK PREP TOOLS



BS-310



BS-1P



BS-3P



BL-3P



BL-28P



BS-3B



STAINLESS STEEL BAR SHAKER SETS

◆ 3-piece sets include shaker cup, built-in strainer, and cap

ITEM	DESCRIPTION	CAPACITY	UOM	CASE
BS-310	Classic 3-Pc Set	10 Oz	Each	12/48
BS-1P	Classic 3-Pc Set	16 Oz	Each	1/24
BS-3P	Classic 3-Pc Set	28 Oz	Each	1/12
BL-3P	Deluxe 3-Pc Set	16 Oz	Each	1/24
BL-28P	Deluxe 3-Pc Set	28 Oz	Each	1/12
BS-3B	Beehive 3-Pc Set	24 Oz	Each	1/24



Use with cold liquids only

BS-16PC



CLEAR PLASTIC BAR SHAKER SET

Provide guests a clear view of colorful cocktails as they are crafted and poured.

- ◆ Measure, shake, and pour with this all-in-one set
- ◆ Built-in strainer for direct, smooth pours
- ◆ Tight-seal cap prevents leaking - cap is also a jigger
- ◆ Capacity markings for precise measuring and mixing
- ◆ Hand wash

ITEM	DESCRIPTION	CAPACITY	UOM	CASE
BS-16PC	Clear Bar Shaker	16 Oz	Each	1/24

STAINLESS STEEL BAR SHAKER CUPS



BS-15

BS-30

MCP-30

BS-28P

ITEM	DESCRIPTION	CAPACITY	UOM	CASE
BS-15	Shaker Cup	15 Oz	Each	12/144
BS-30	Shaker Cup	30 Oz	Each	12/72
MCP-30	Malt Cup	30 Oz	Each	12/72
BS-28P	PVC Exterior	28 Oz	Each	24/48



WG10-001



16 OUNCE MIXING GLASS

◆ 24-pieces per case

ITEM	DESCRIPTION	CAPACITY	UOM	CASE
WG10-001	Clear	16 Oz	Case	1

STAINLESS STEEL JAPANESE-STYLE JIGGERS

Consistency is key for the right mix and perfect balance.

- ◆ Made to measure and pour with style
- ◆ Dual-sided capacities

ITEM	DESCRIPTION	UOM	CASE
J-6	1/2 Oz x 3/4 Oz	Each	12/300
J-7	1/2 Oz x 1 Oz	Each	12/300
J-8	1 Oz x 1-1/4 Oz	Each	12/300
J-9	1 Oz x 2 Oz	Each	12/300



J-9



J-6

STAINLESS STEEL STANDARD JIGGERS

- ◆ Dual-sided capacities

ITEM	DESCRIPTION	UOM	CASE
J-1	1/2 Oz x 1 Oz	Each	12/300
J-2	3/4 Oz x 1-1/4 Oz	Each	12/300
J-3	3/4 Oz x 1-1/2 Oz	Each	12/300
J-4	1 Oz x 1-1/2 Oz	Each	12/300
J-5	1 Oz x 2 Oz	Each	12/300



J-3



J-1

BAR MAID® STAINLESS STEEL CONE MESH STRAINER

- ◆ Cone shape directs liquid flow into the glass with no spills
- ◆ Mesh allows fast pour while effectively straining ice / pulp

ITEM	DESCRIPTION	UOM	CASE
CR-1262	3" Stainless Steel, Cone Shaped Mesh Strainer	Each	1/6



NEW
CR-1262

STAINLESS STEEL FINE MESH STRAINER

- ◆ Fine mesh effectively catches pulp and small seeds

ITEM	DESCRIPTION	UOM	CASE
MS2K-3S	3"Dia x 8"L x 1"H	Each	24/144



MS2K-3S

STAINLESS STEEL STRAINERS

- ◆ Strain and drain

ITEM	DESCRIPTION	UOM	CASE
BST-4P	4-Prong Spring Strainer	Each	12/288
JST-1	Julep Strainer	Each	12/240



JST-1



BST-4P

STAINLESS STEEL LONG BAR SPOON

ITEM	DESCRIPTION	UOM	CASE
BPS-11	11" Bar Spoon	Each	24/600

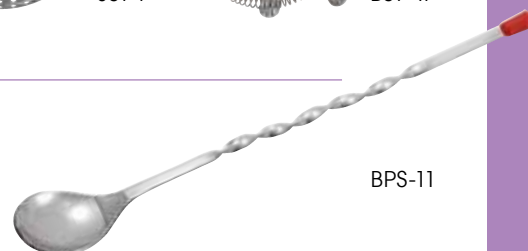

BPS-11

STAINLESS STEEL BEER LAYERING SPOON

- ◆ Ridge rests over lip of the glass for slow pour

ITEM	DESCRIPTION	UOM	CASE
BLS-6	1-5/8" Dia, S/S	Each	12/48



BLS-6

CITRUS WEDGER & SQUEEZERS



WEG-816



BAR MAID® CITRUS WEDGER

- ◆ Cut whole lemons / limes into 8 or 16 wedges
- ◆ Quick, consistent size pieces every time
- ◆ Non-skid rubber feet for stability
- ◆ Replacable blade

ITEM	DESCRIPTION	UOM	CASE
WEG-816	Citrus Wedger (8 Or 16 Wedge)	Box	1/4
WEG-BLADE	Replacement Blade	Box	1/6



JC-19

Base fits a standard glass/cup



PREMIUM HAND-PRESS CITRUS JUICER

Extract juice from fresh fruits with ease, maximizing yield by squeezing out every last drop. The strainer catches seeds and pulp, while fresh-squeezed juice pours out.

- ◆ Sturdy, reinforced base with rubber feet prevent sliding
- ◆ Strong steel post support and smooth lever action
- ◆ Ideal for medium to small citrus fruits
- ◆ Base accommodates standard glass/cup (not included)

ITEM	DESCRIPTION	UOM	CASE
JC-19	19"H Premium Juicer	Each	1/2



LS-8G



LS-9Y



LS-9O



HANDHELD CITRUS SQUEEZERS

Extract all the juice without the rind, pulp, or seeds.

- ◆ Aluminum with baked-on enamel coating
- ◆ Place citrus half with the cut side down in juicer and extract
- ◆ Dishwasher safe, long lasting, won't absorb odors, and resistant to moisture, heat, and stains

ITEM	DESCRIPTION	UOM	CASE
LS-8G	2-1/2"Dia, 8"L Squeezer	Each	6/48
LS-9Y	3"Dia, 8-3/4"L Squeezer	Each	6/48
LS-9O	3-1/2"Dia, 9-1/8"L Squeezer	Each	9/36

STAINLESS STEEL CITRUS JUICER & SQUEEZER



JC-4



LS-3



ITEM	DESCRIPTION	UOM	CASE
JC-4	5"Dia Juicer	Each	24
LS-3	6"Dia Squeezer	Each	12/144

6" X 10" X 1/2" GARNISH CUTTING BOARDS

Tough surface reduces knife dulling and durable co-polymer prevents warping.

- ◆ Ideal size for prepping garnishes behind the bar
- ◆ Dishwasher safe

ITEM	DESCRIPTION	UOM	CASE
CBN-610WT	Statik Board™, White	Each	20
CBWT-610	Flat Board, White	Each	20

STATIKboard™



GARNISH CUTTING BOARDS



CBN-610WT



CBWT-610

MUDDLERS

- ◆ Essential tool for crafting muddled "stick" drinks
- ◆ 8" long reaches the bottom of standard glasses

ITEM	DESCRIPTION	UOM	CASE
CR-1240	Bar Maid, Plastic, Black, 3/4" Dia	Each	1/48



MUDDLERS



CR-1240



SBM-8N



WMW-8

ITEM	DESCRIPTION	UOM	CASE
SBM-8N	Netted Head, S/S Hd	Each	12/96
WMW-8	Flat Head, Wooden	Each	24/144

MARBLE MORTAR & PESTLE SET

- ◆ Grind, crush, blend
- ◆ 4-1/2" diameter bowl

ITEM	DESCRIPTION	UOM	CASE
MPS-42W	Mortar & Pestle	Set	1/12



MPS-42W

BLACK PLASTIC GLASS RIMMERS

ITEM	DESCRIPTION	UOM	CASE
GR-2	2-Tier, Plastic w/Sponge	Each	1/12
GR-3	3-Tier, Plastic w/Sponge, NSF	Each	1/12
GR-3S	Replacement Sponge, No Retail Packaging	Each	12/144

GLASS RIMMERS



GR-3S



GR-3 NSF

BAR MAID® MARGARITA SALT

ITEM	DESCRIPTION	UOM	CASE
CR-102	White, Lime Flavor, 6 Oz, 12-Pcs/Case	Case	1



CR-102

CONDIMENT CADDIES



CDP-4



CDP-5

STAINLESS STEEL CONDIMENT HOLDERS

- ◆ Hollow bottom, can place on top of ice bed to chill
- ◆ Clear-view plastic hinged lid keeps contents free of debris

ITEM	DESCRIPTION	UOM	CASE
▶ CDP-4	4 Compartments	Each	1/16
▶ CDP-5	5 Compartments	Each	1/16
▶ CDP-6	6 Compartments	Each	1/16
CDP-1P	1pt Insert for CDP-4/5/6	Each	120
CDP-1Q	1qt Insert for CDP-4/5/6	Each	60



CDP-6 shown filled



NSF CCH-4

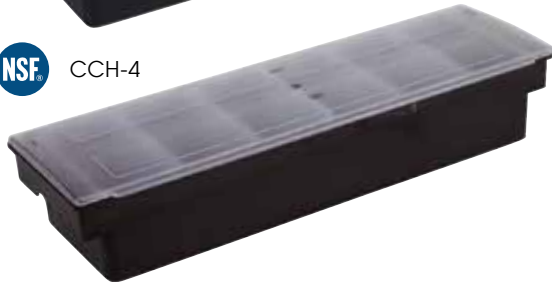

NSF CCH-6



CCH-4IS



CCH-6IS

PLASTIC CONDIMENT HOLDERS

- ◆ Includes lid & removable food-grade poly inserts
- ◆ Dishwasher safe

ITEM	DESCRIPTION	SIZE (L X W X H)	UOM	CASE
▶ CCH-4	4 Compartments, Black, NSF	19-3/8" x 6-1/4" x 3-3/4"	Each	1/6
▶ CCH-6	6 Compartments, Black, NSF	19-7/16" x 6-1/4" x 3-1/2"	Each	1/6
CCH-4IS	Inserts for CCH-4, 4-Pcs/Pk		Pack	24
CCH-6IS	Inserts for CCH-6, 6-Pcs/Pk		Pack	24
BC-4P	4 Compartments, White	18" x 5" x 3"	Set	6/36

There is no space for ice under the compartments.



BC-4P

PLASTIC BAR CADDY

- ◆ Multiple sized compartments to hold supplies

ITEM	DESCRIPTION	UOM	CASE
BC-6	6 Compartments, Plastic	Each	12



NSF

BPA FREE

BC-6

POWER & PERFORMANCE



High-performance motor with impact-resistant stainless steel blades adds power and performance to your busy establishment.

BAR MAID® 68 OZ (2 L) COMMERCIAL BLENDER

- ◆ 68 oz (2 L), break-resistant and BPA-free Tritan™ container
- ◆ High-performance 2 hp motor; unique high-impact blades
- ◆ Metal-to-metal coupling; easy to operate "PULSE"
- ◆ "ON /OFF" paddle controls & variable speed control dial
- ◆ Container/pitcher is heat-resistant up to 226°F (108°C); reduce pressure by removing cap in the lid
- ◆ Removable container cover and cap for adding/blending ingredients mid-cycle
- ◆ 11-1/2" tamper included - fits through lid opening and reaches full length of container to blend/stir while mixing
- ◆ All parts (except bases & blade fixing block) are dishwasher safe

OVERALL DIMENSIONS L" X D" X H" (mm)	POWER	PLUG	SHIP WEIGHT
8-11/16 x 9-13/16 x 19-15/16 (220 x 249 x 490)	120V~60Hz, 1450W, 12.1A	NEMA 5-15P	10.4 lbs (4.7 kgs)
CONTAINER DIMENSIONS L" X D" X H" (mm)			
6-11/16 x 6-11/16 x 12-3/8 (178 x 18 x 314)			

ITEM	DESCRIPTION	UOM	CASE
XLB-1000	Bar Maid 68 Oz Blender	Set	1/4
XLB1000P2	Pitcher Assembly	Each	1
XLB1000P19	Blade Removal Tool	Each	1

BLENDERS

Blade removal tool included



XLB1000P19

XLB-1000



TRITAN™ CONTAINER



BAR MAID® 44 OZ (1.25 L) 2-SPEED QUIET BAR BLENDER

- ◆ 44 oz (1.25 L), break-resistant and BPA-free Tritan™ container
- ◆ Quiet, high-performance 1/2 hp self-lubricating motor; uniquely designed high-impact blades
- ◆ HIGH/LOW toggle switch for precise consistency control
- ◆ Blade is removable for easy cleaning
- ◆ Non-skid feet securely grip the surface for stable operation
- ◆ Removable container cover and cap for adding/blending ingredients mid-cycle

OVERALL DIMENSIONS L" X D" X H" (mm)	POWER	PLUG	SHIP WEIGHT
7 x 7-7/16 x 15-7/16 (178 x 189 x 392)	120V~60Hz, 400W, 3.5A	NEMA 5-15P	5.5 lbs (2.5 kgs)
CONTAINER DIMENSIONS L" X D" X H" (mm)			
7 x 8-1/8 x 9-1/4 (178 x 130 x 235)			

ITEM	DESCRIPTION	UOM	CASE
XLB-44	Bar Maid 44 Oz Blender	Set	1/4
XLB44-P10	Pitcher Assembly	Each	1



XLB-44



TRITAN™ CONTAINER



BAR DRINKWARE



CMM-20



CMM-20H



COPPER-PLATED MOSCOW MULE MUGS

- ◆ Traditional mug for serving the Moscow Mule drink for optimal taste, temperature, and presentation
- ◆ Maintains a cool temperature for cold, frosty drinks
- ◆ Wide handle for minimal hand-to-mug contact
- ◆ Corrosion resistant copper-plating, lead-free brass handles

ITEM	DESCRIPTION	CAPACITY	UOM	CASE
CMM-20	Smooth	20 Oz	Each	36
CMM-20H	Hammered	20 Oz	Each	36



DDSE-101S



DDSE-102S



STAINLESS STEEL MINT JULEP CUPS

- ◆ Traditional cup for crafting the iconic Mint Julep in keeps drinks icy cold while sipping

ITEM	DESCRIPTION	CAPACITY	UOM	CASE
DDSE-101S	3"Dia x 4-3/8"H	12 Oz	Each	12/72
DDSE-102S	3-3/8"Dia x 4-3/4"H	15 Oz	Each	12/72

DECORATIVE PICKS



PK-KT3



PK-KT4



PK-KT7

100pcs
per pack,
per size



DECORATIVE BAMBOO FOOD PICKS

- ◆ Versatile solution to hold together sandwiches/wraps, or garnish beverages with style
- ◆ Knotted end allows easy pick-up of individual portions
- ◆ Eco-friendly

ITEM	DESCRIPTION	SIZE	PCS/BAG	UOM	CASE
PK-KT3	Bamboo	3"	100	Pack	12/120
PK-KT4	Bamboo	4"	100	Pack	12/120
PK-KT7	Bamboo	7"	100	Pack	12/120



PK-P4



PK-S3



PK-A35



DECORATIVE FOOD PICKS

- ◆ Hanging retail packaging

ITEM	DESCRIPTION	SIZE	PCS/BAG	UOM	CASE
PK-P4	Parasol	3-15/16"	144	Bag	100
PK-C2	Cellophane Frills	2-9/16"	1,000	Bag	10
PK-C4	Cellophane Frills	3-15/16"	1,000	Bag	10
PK-A35	Plastic Arrow	3-7/16"	500	Bag	20
PK-S3	Plastic Sword	2-3/4"	500	Bag	20



PK-C4



PK-C2

STRAWS



SSTW-8S



SSTW-8C

18/8 STAINLESS STEEL DRINKING STRAWS

- ◆ Reusable, environmentally-friendly
- ◆ Each straw measures 1/4" diameter x 8-1/2" long
- ◆ 5-piece set includes 4 straws and 1 cleaning brush
- ◆ Dishwasher safe

ITEM	DESCRIPTION	UOM	CASE
SSTW-8C	Curved S/S Straws	Set	12/48
SSTW-8S	Straight S/S Straws	Set	12/48

ASH TRAYS



MAS-4R



MAS-4K



SAS-4



PLASTIC ASHTRAYS

- ◆ Heat resistant up to 338°F (170°C)

ITEM	DESCRIPTION	UOM	CASE
MAS-4K	4"Dia, Black	Doz	12
MAS-4R	4"Dia, Red	Doz	12

STAINLESS STEEL ASHTRAY

ITEM	DESCRIPTION	UOM	CASE
SAS-4	4"Dia, Stackable	Each	24/96

GET THE PARTY STARTED



BAR MAID® 0.85OZ SHOOTER TUBES & RACK

Perfect for serving single liquor or bulk-mixed shots.

- ◆ Each shooter tube is 1/2" dia x 6" tall
- ◆ Notched rack base allows for a comfortable one-handed server grip; holds 24 tubes

ITEM	DESCRIPTION	PCS / PACK	UOM	CASE
CR-1600	Rack For Shooter Tubes, 24 Slots, Clear	1	Each	1/12
CR-1610CL	Shooter Tubes, Clear	100	Pack	1/10
CR-1610CLB	Shooter Tubes, Clear	1,000	Case	1
CR-1620AC	Shooter Tubes, Assst Neon	100	Pack	1/10
CR-1620ACB	Shooter Tubes, Assst Neon	1,000	Case	1

SHOOTER TUBES & WRISTBANDS



CR-1620AC with CR-1600



BAR MAID® WATERPROOF TEAR-FREE WRISTBANDS

- ◆ No-tear Tyvek®, each band 3/4" wide x 10" long
- ◆ Sequentially numbered
- ◆ Economical security option



ITEM	DESCRIPTION	PCS / PACK	UOM	CASE
WB-100B-D	Blue Pattern	500	Pack	1/20
WB-100B-S	Blue Solid	500	Pack	1/20
WB-100G-D	Green Pattern	500	Pack	1/20
WB-100G-S	Green Solid	500	Pack	1/20
WB-100O-D	Orange Pattern	500	Pack	1/20
WB-100O-S	Orange Solid	500	Pack	1/20
WB-100PI-S	Pink Solid	500	Pack	1/20
WB-100PU-S	Purple Solid	500	Pack	1/20
WB-100R-D	Red Pattern	500	Pack	1/20
WB-100R-S	Red Solid	500	Pack	1/20
WB-100Y-D	Yellow Pattern	500	Pack	1/20
WB-100Y-S	Yellow Solid	500	Pack	1/20
WB-CHECKER	Checkerboard (Red/Black)	500	Pack	1/20
WB-FLAG	American Flag	500	Pack	1/20
WB-OVER21	OVER 21 (Prpl/Blck)	500	Pack	1/20
WB-STARS	Stars (Prpl/Blk)	500	Pack	1/20
WB-TATTOO	Tattoo (Green/Black)	500	Pack	1/20
WB-VIP	VIP (Gold/Black)	500	Pack	1/20

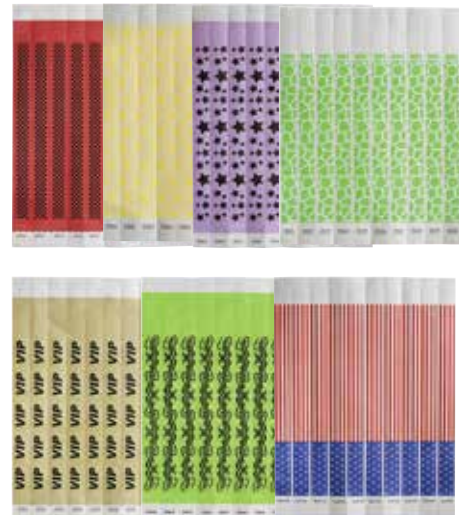

ACRYLIC STRAW DISPENSER

- ◆ Easily turn the roller to dispense a straw
- ◆ Holds up to 250, 10" long straws

ITEM	DESCRIPTION	UOM	CASE
ACSD-712	10-3/4"L x 4-3/4"W x 7"H	Each	6

STRAW DISPENSERS



ACSD-712 **BPA FREE**



SDP-3 **BPA FREE**

SAN PLASTIC VERTICAL STRAW DISPENSER

- ◆ Clear, break-resistant SAN plastic cylinder
- ◆ Stainless steel pull-up lid and dispenser insert
- ◆ Holds up to 100, 10" long straws

ITEM	DESCRIPTION	UOM	CASE
SDP-3	3-3/8"Dia x 10-3/4"H	Each	1/12



BOTTLE/CAN OPENERS

Twist & Out™

REDUCES HAND FATIGUE



Front gears Back handle
CO-902



Front gears Back handle
CO-901

FEEL THE SOFT GRIP



Twist & Out™ hanging packaging

TWIST & OUT™ CHROME-PLATED CAN OPENERS

- ◆ Soft-grip handle helps to reduce hand fatigue while providing leverage when turning the crank
- ◆ Smooth cutting blade makes all-day prep easier
- ◆ Durable frame - opens #10 cans with ease

ITEM	DESCRIPTION	UOM	CASE
CO-901	7"L, Easy-Turn Handle	Each	12/48
CO-902	8-3/4"L, Crank Handle	Each	12/48



CO-530

CLASSIC CAN OPENER

ITEM	DESCRIPTION	UOM	CASE
CO-530	White Handles	Each	12/72

CORKSCREWS

DOUBLE-HINGED CORKSCREW

ITEM	DESCRIPTION	UOM	CASE
CO-720	Double-Hinged Corkscrew	Each	6/96



CO-720



CO-501



CO-701

WING-STYLE CORKSCREWS

ITEM	DESCRIPTION	UOM	CASE
CO-501	Wing Type, Chrome	Each	12/144
CO-701	Wing Type, Black	Each	12/72

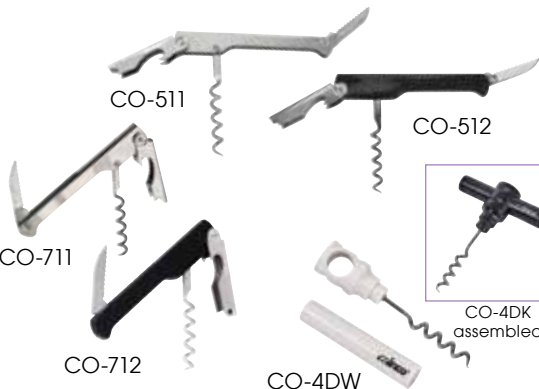

CO-511

CO-512

CO-711

CO-712

CO-4DW



CO-4DK assembled

CORKSCREWS

ITEM	DESCRIPTION	UOM	CASE
CO-511	Waiter's Corkscrew, S/S, Made in Italy	Each	12/144
CO-512	Waiter's Corkscrew, Black, Made in Italy	Each	12/144
CO-711	Waiter's Corkscrew, S/S, Economy	Each	12/144
CO-712	Waiter's Corkscrew, Black, Economy	Each	12/144
CO-4DK	Black, 2-Sets/Pk	Pack	24/96
CO-4DW	White, 2-Sets/Pk	Pack	24/96

STAINLESS STEEL FLAT BOTTLE OPENERS

- ◆ Keep speed openers on hand to maintain a quick, productive pace behind the bar
- ◆ Easy to store, carry, and saves time

ITEM	DESCRIPTION	UOM	CASE
CO-301	Uncoated	Each	12/144
CO-301PB	PVC Coated - Blue	Each	12/144
CO-301PK	PVC Coated - Black	Each	12/144
CO-301PR	PVC Coated - Red	Each	12/144

Open bottles fast
with bar keys

BOTTLE OPENERS



CO-301



CO-301PB



CO-301PK



CO-301PR

CAN TAPPERS/BOTTLE OPENERS

ITEM	DESCRIPTION	UOM	CASE
CO-201	Nickel Plated, 4"	Each	100/600
CO-302	Stainless Steel, 7"	Each	12/144
CO-303	Wooden Hdl, S/S, 7"	Each	12/144



CO-201



CO-302



CO-303

DIE-CAST ZINC ALLOY WALL-MOUNT BOTTLE OPENER

- ◆ Wall-mount or affix to bar counters for easy accessibility
- ◆ Includes mounting screws

ITEM	DESCRIPTION	UOM	CASE
CO-402	3-1/4"L x 2-3/4"W	Each	24/144

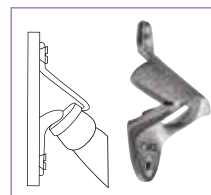

CO-402 In use,
side view



CO-402

STAINLESS STEEL UNDER-COUNTER BOTTLE OPENER

ITEM	DESCRIPTION	UOM	CASE
CO-401	4-1/4"	Each	24/288



CO-401

BOTTLE CAP CATCH

ITEM	DESCRIPTION	UOM	CASE
BCH-14	5-1/2"L x 3-1/2"W x 13-3/4"H	Each	1/24

BCH-14



ICE CUBE TRAYS

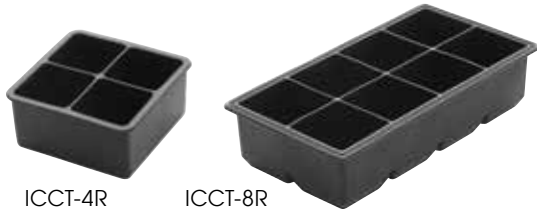

ICCT-4R

ICCT-8R



BLACK SILICONE ICE TRAYS

Make large 2" cubes or spheres of ice and keep drinks chilled longer than with typical ice cubes.

- ◆ Flexible, easy-release silicone
- ◆ 2" ice cubes / spheres fit any standard Whiskey glass
- ◆ The 2-part sphere ice tray seals closed to prevent spills; holes for easy, complete filling

ITEM	DESCRIPTION	UOM	CASE
ICCT-4R	4-Cube Ice Tray	Each	12/72
ICCT-8R	8-Cube Ice Tray	Each	12/72
ICCP-8K	8-Sphere Ice Tray	Each	12/72



ICCP-8K



2-piece tray



PLASTIC SPHERE-ICE TRAY

Extend the chill with large round craft-ice spheres that melt slower than standard-size ice cubes.

- ◆ Made of sturdy, stackable polypropylene
- ◆ Makes six perfectly round 2" cubes
- ◆ Easy-fill 2-piece tray, and stackable for freezing

ITEM	DESCRIPTION	UOM	CASE
ICCP-6W	6-Cube Tray	Each	12/72



ICCP-6W



2-piece tray



ICE TOOLS



ICH-1

NICKELED STEEL ICE PICK

- ◆ Wooden handle

ITEM	DESCRIPTION	UOM	CASE
ICH-1	9" Ice Pick	Each	24/144



ICH-9

NICKELED STEEL 6-PRONG ICE CHIPPER

- ◆ Wooden handle

ITEM	DESCRIPTION	UOM	CASE
ICH-9	9" Ice Chipper, Six Prong	Each	12/120



ICT-7 Texture



ICT-7

IT-7



STAINLESS STEEL ICE TONGS

ITEM	DESCRIPTION	UOM	CASE
ICT-7	7"L, Five Prong, Textured	Each	12/144
IT-7	7"L, Three Prong, Satin Finish	Each	12/120



PT-6

STAINLESS STEEL POM TONGS

ITEM	DESCRIPTION	UOM	CASE
PT-6	6"L, Satin Finish	Doz	4/24
PT-9	9"L, Satin Finish	Doz	4/24



IS-4

STAINLESS STEEL ICE SCOOP

ITEM	DESCRIPTION	UOM	CASE
IS-4	4 Oz Scoop	Each	12/144



POLYCARBONATE SCOOP

ITEM	DESCRIPTION	UOM	CASE
PS-5	5 Oz Scoop	Each	24/144



PS-5



STAINLESS STEEL DOUBLE-WALL ICE BUCKET

- ◆ Double-wall insulation prevents condensation
- ◆ Maintains temperature to keep ice cold longer

ITEM	DESCRIPTION	UOM	CASE
ICB-60	60 Oz Ice Bucket	Each	1/8

ICE BUCKET



Pom tongs sold separately (PT-6)



ICB-60

MANUAL CRANK ICE CRUSHER

Quickly chop coarse to fine ice chips.

- ◆ 6" x 4-7/8" x 9-1/2" high

ITEM	DESCRIPTION	UOM	CASE
ICP-9	Ice Crusher	Each	1/12

ICE CRUSHER



ICP-9

"ICE ONLY" STORAGE CONTAINERS

ITEM	DESCRIPTION	UOM	CASE
FCW-10ICE	10 Gal "Ice Only" Container	Each	1/6
FCW-10L	Lid for FCW-10ICE	Each	1/24

"ICE ONLY" CONTAINERS



FCW-10L



FCW-10ICE

FCW-SERIES



INSULATED MOBILE ICE CADDY

- ◆ 125 lb capacity
- ◆ Can be used inside or outdoors, in hot or humid conditions
- ◆ Drain shelf keeps ice separate from the water, greatly increasing storage time
- ◆ Polyethylene molded body is durable and light-weight, top lid slides open
- ◆ Polyurethane foam insulation effectively keeps ice cold for several days
- ◆ Recessed front handle for convenient pulling or lifting
- ◆ No assembly required

INSULATED ICE CADDY



IIC-29

IIC-SERIES



ITEM	DESCRIPTION	SIZE	UOM	CASE
IIC-29	Ice Caddy w/Sliding Lid	Ext Dim: 23"L x 31.5"W x 29.25"H	Set	1
IIC-C8	Caster For IIC-29	8"Dia	Each	1
IIC-C5B	Brake Caster for IIC-29	5"Dia	Each	6





PREMIUM POUR FOR THE ULTIMATE IN ACCURACY

POURERS



BMP-2125G-PKG

PREMIUM MEASURED POURERS

Bar Maid measured pourers provide accurate, consistent pours and place the power over profits in the hands of the bar owner.

- ◆ Pourer ball bearings don't fall into the bottle thanks to our special patented design
- ◆ Smooth pour with less sticking ensured by a primer ring to channel liquor around the inner ball bearing
- ◆ Greater accuracy means more profit per bottle thanks to the patented three-ball design
- ◆ Easy removal with our "lock-on" collar
- ◆ Three popular shot sizes 1oz, 1-1/4oz, 1-1/2oz, wide cork (larger bottles), and flip-tops (keeps the fruit flies out)
- ◆ MADE IN USA



"PREMIUM POUR" MEASURED POURERS - NO COLLAR - 12-PCS/PACK

ITEM	DESCRIPTION	COLOR	UOM	CASE
BMP-1100B	1 oz	Blue	Pack	1/12
BMP-1125C	1-1/4 oz	Clear	Pack	1/12
BMP-1150B	1-1/2 oz	Blue	Pack	1/12
BMP-1150C	1-1/2 oz	Clear	Pack	1/12
BMP-2100C	1 oz, Wide Cork	Clear	Pack	1/12
BMP-2125C	1-1/4 oz, Wide Cork	Clear	Pack	1/12
BMP-2125G	1-1/4 oz, Wide Cork	Green	Pack	1/12
BMP-2125G-PKG	1-1/4 oz, Wide Cork, 2 pcs/pk	Green	Pack	1/24



BMP-1100B BMP-1125C BMP-2125C BMP-2125G



"PREMIUM POUR" MEASURED POURERS - BLACK COLLAR - 12-PCS/PACK

ITEM	DESCRIPTION	COLOR	UOM	CASE
BMP-3100B	1 oz	Blue	Pack	1/12
BMP-3100C	1 oz	Clear	Pack	1/12
BMP-3100R	1 oz	Red	Pack	1/12
BMP-3100R-PKG	1 oz, 2 pcs/pk	Red	Pack	1/24
BMP-3125C	1-1/4 oz	Clear	Pack	1/12
BMP-3125C-PKG	1-1/4 oz, 2 pcs/pk	Clear	Pack	1/24
BMP-3150B	1-1/2 oz	Blue	Pack	1/12
BMP-3150C	1-1/2 oz	Clear	Pack	1/12



BMP-3100B BMP-3100C BMP-3100R



"PREMIUM POUR" MEASURED POURERS - NO COLLAR, FLIP TOP - 12-PCS/PACK

ITEM	DESCRIPTION	COLOR	UOM	CASE
BMP-4100B	1 oz	Blue	Pack	1/12
BMP-4100C	1 oz	Clear	Pack	1/12
BMP-4125C	1-1/4 oz	Clear	Pack	1/12
BMP-4125C-PKG	1-1/4 oz, 2 pcs/pk	Clear	Pack	1/24
BMP-4150B	1-1/2 oz	Blue	Pack	1/12
BMP-4150C	1-1/2 oz	Clear	Pack	1/12



BMP-4100B BMP-4100C

- ✓ **SPEED & CONSISTENCY**
- ✓ **ACCURACY & PRECISION**
- ✓ **LESS WASTE**
- ✓ **MORE PROFIT**



"PREMIUM POUR" MEASURED POURERS - BLACK COLLAR WITH FLIP TOP - 12-PCS/PACK

ITEM	DESCRIPTION	COLOR	UOM	CASE
BMP-5100B	1 oz	Blue	Pack	1/12
BMP-5100B-PKG	1 oz, 2 pcs/pk	Blue	Pack	1/24
BMP-5100C	1 oz	Clear	Pack	1/12
BMP-5100R	1 oz	Red	Pack	1/12
BMP-5125B	1-1/4 oz	Blue	Pack	1/12
BMP-5125C	1-1/4 oz	Clear	Pack	1/12
BMP-5150B	1-1/2 oz	Blue	Pack	1/12
BMP-5150C	1-1/2 oz	Clear	Pack	1/12

POURERS



BMP-5100B BMP-5100C BMP-5100R

"BETTERWAY" PLASTIC POURER - 12-PCS/PACK

ITEM	DESCRIPTION	COLOR	UOM	CASE
CR-400	Black Collar	Clear	Pack	1/24



CR-400

"BETTERWAY" STAINLESS STEEL SPEED POURERS - 12-PCS/PACK

ITEM	DESCRIPTION	UOM	CASE
CR-220P	Speed Pourers, Poly Cork, No Screen	Pack	1/24
CR-285P	Medium Speed Pourers, Tapered, Poly Cork, No Screen	Pack	1/24
CR-285PW	Medium Speed Pourers, Tapered, Wide Poly Cork, No Screen	Pack	1/24



CR-220P CR-285P CR-285PW

"BETTERWAY" STAINLESS STEEL POURER DUST CAPS - 72-PCS/PACK

- ◆ Protect pour spouts from pests and dust
- ◆ MADE IN USA

ITEM	DESCRIPTION	COLOR	UOM	CASE
CR-285CAP	Dust Cap For CR-285P, CR-285PW	Black	Pack	1/24



CR-285CAP

"KOVER-ALL" UNIVERSAL POURER DUST CAPS

- ◆ Protect open bottles and pour spouts from pests and dust
- ◆ Flexible plastic

ITEM	DESCRIPTION	UOM	CASE
CR-300UN	Kover-All Universal Dust Cap, 12-Pcs/Pk	Pack	1/24
PC-1	Standard Universal Dust Cap	Doz	48



PC-1 CR-300UN



POURERS



PPA-SERIES



MEASURED POURERS

Prevent over-pouring with measured pourers and reduce liquor costs up to 30%.

◆ Color-coded

ITEM	DESCRIPTION	UOM	CASE
PPA-050	1/2 Oz, Orange Tail	Doz	25
PPA-063	5/8 Oz, Black Tail	Doz	25
PPA-075	3/4 Oz, Green Tail	Doz	25
PPA-087	7/8 Oz, Blue Tail	Doz	25
PPA-100	1 Oz, Red Tail	Doz	25
PPA-113	1-1/8 Oz, Purple Tail	Doz	25
PPA-125	1-1/4 Oz, Clear Tail	Doz	25
PPA-150	1-1/2 Oz, Yellow Tail	Doz	25
PPA-200	2 Oz, White Tail	Doz	25



23752

23772

23782

EXACT™ MEASURED POURERS

3-ball technology provides the most exact pour in the industry.

ITEM	DESCRIPTION	PCS/PACK	UOM	CASE
23752	1 oz, Red Tail	12	Pack	1/25
23772	1-1/4 oz, Clear Tail	12	Pack	1/25
23782	1-1/2 oz, Yellow Tail	12	Pack	1/25



23210

EXACT™ SCREENED POURERS

Collared screened pourers allow for continuous free-flow pouring while preventing fruit flies/bugs from entering the bottle.

ITEM	DESCRIPTION	PCS/PACK	UOM	CASE
23210	Clear	12	Pack	1/25



PP-SERIES



SCREENED POURERS

- ◆ Screened spout keeps bugs and dirt out of bottle
- ◆ Spout is bent at the angle to achieve a perfect pour

ITEM	DESCRIPTION	UOM	CASE
PP-SAM	Gemstone Amber	Doz	12/48
PP-SCL	Crystal Clear	Doz	12/48
PP-SSM	Midnight Smoke	Doz	12/48



PPR-2-SERIES



ECONOMY FREE-FLOW POURERS

- ◆ Delivers quick, consistent, controlled pours with a steady, smooth flow
- ◆ Use as part of a color-coded system for training/memorization and organizing an efficient bar service
- ◆ Durable commercial-grade plastic

ITEM	DESCRIPTION	UOM	CASE
PPR-2B	Blue	Doz	12/72
PPR-2C	Clear	Doz	12/72
PPR-2G	Green	Doz	12/72
PPR-2K	Black	Doz	12/72
PPR-2R	Red	Doz	12/72
PPR-2W	White	Doz	12/72
PPR-2Y	Yellow	Doz	12/72

POURERS

CLASSIC CHROME POURERS

- ◆ Chrome spout
- ◆ Fast flow with plastic breather tube
- ◆ Food-grade poly-plastic cork

ITEM	DESCRIPTION	UOM	CASE
PP-C	Black Collar	Doz	12/48
PP-NC	No Collar	Doz	12/48



PP-NC



PP-C

CLASSIC STAINLESS STEEL METAL POURERS

- ◆ Breather tube and different pourer opening sizes provide various flow speeds
- ◆ Food-grade poly-plastic cork

ITEM	DESCRIPTION	UOM	CASE
PPM-4	Tapered Spout, Med Flow	Doz	12/48
PPM-4C	Tapered Spout with Hinged Cap, Med/Fast Flow	Doz	12/48
PPM-4G	Gooseneck Spout, Fast Flow	Doz	12/48
PPM-4J	Jet Spout, Extra Fast Flow	Doz	12/48



PPM-4



PPM-4C



PPM-4G



PPM-4J

OVERSIZED METAL POURER

- ◆ Stainless steel breather tube
- ◆ For use with 1.75 Liter, 1/2 gallon and gallon bottles
- ◆ Food-grade poly-plastic cork

ITEM	DESCRIPTION	UOM	CASE
PPM-6	Oversized Tapered Spout, Med Flow	Doz	12/48



PPM-6

FLEXIBLE PLASTIC POURER

ITEM	DESCRIPTION	UOM	CASE
PPR-1	Black Flex Pourer	Each	12/120



PPR-1



POUR BOTTLES



PPB-SERIES

LIQUOR & JUICE POUR BOTTLES

- ◆ Color-coded nozzle and lid

ITEM	DESCRIPTION	UOM	CASE
PPB-1B	1 Qt, Brown	Each	12
PPB-1G	1 Qt, Green	Each	12
PPB-1O	1 Qt, Orange	Each	12
PPB-1R	1 Qt, Red	Each	12
PPB-1W	1 Qt, White	Each	12
PPB-1Y	1 Qt, Yellow	Each	12
PPB-2B	2 Qt, Brown	Each	12
PPB-2G	2 Qt, Green	Each	12
PPB-2O	2 Qt, Orange	Each	12
PPB-2R	2 Qt, Red	Each	12
PPB-2W	2 Qt, White	Each	12
PPB-2Y	2 Qt, Yellow	Each	12

LIQUOR & JUICE POUR BOTTLE SETS

- ◆ Color-coded nozzle and lid
- ◆ Sets include 1 Red, 1 Orange, 1 Green, 1 Yellow, 1 White, & 1 Brown
- ◆ 12 bottles per case with two of each color

ITEM	DESCRIPTION	UOM	CASE
PPB-1MX	1 Qt	Case	1
PPB-2MX	2 Qt	Case	1



PFBT-11W

PLASTIC FLAIR BOTTLE

- ◆ Learn and practice mixing with style

ITEM	DESCRIPTION	UOM	CASE
PFBT-11W	12-1/2"H	Each	4/24

PUMP KITS



8" tube can be trimmed to custom length

Set includes pump, tube, 3 capacity restrictors

PKT-1



PUMP DISPENSER WITH 3 RESTRICTORS SET

- ◆ Perfect for condiments, hand sanitizer and hand soap
- ◆ 1-1/2" dia cap fits most 1 gallon jug
- ◆ Restricts 1 oz, 3/4 oz, 1/2 oz, 1/4 oz capacities

ITEM	DESCRIPTION	UOM	CASE
PKT-1	17" O.L. Fits 1-1/2" Dia Opening	Set	12/72

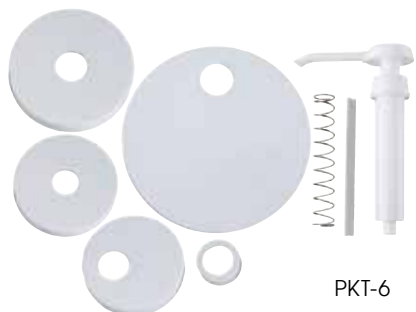

PKT-6



PLASTIC PUMP DISPENSER KIT FOR SYRUP & LIQUORS

- ◆ Includes 9" standard size pump
- ◆ 5 lid sizes:
 - 1-9/16" threaded
 - 3-11/16" threaded
 - 4-1/2" threaded
 - 4-1/2" snap on
 - 6-5/16" snap on

ITEM	DESCRIPTION	UOM	CASE
PKT-6	White Pump Kit	Set	12/72

BAR MAID® WINE POURER

- ◆ Pours a true, full 5 ounces
- ◆ Universal fit on any size bottle
- ◆ Patented design ensures ball bearings stay intact
- ◆ Easy removal with our "lock-on" collar
- ◆ Quick and easy to clean

ITEM	DESCRIPTION	UOM	CASE
BMP-500RAC	5 oz, Amber w/ Black Collar	Each	1/12

WINE POURER, AERATOR, & BOTTLE STOPPERS



BMP-500RAC



BAR MAID® WINE AERATOR

- ◆ Attractive "Pourer" design aerates as wine is poured
- ◆ Universal fit on any size bottle
- ◆ Ensures red and white wine tastes its best at the time it is poured
- ◆ Quick and easy to clean

ITEM	DESCRIPTION	UOM	CASE
BMP-600AR	Professional Wine Aerator, 2-Pcs/Pk	Each	1/24



BMP-600AR



WINE BOTTLE STOPPERS

- ◆ Stainless steel clip
- ◆ Food-grade thermoplastic cork

ITEM	DESCRIPTION	UOM	CASE
WBS-R	Red Collar	Doz	12/48
WBS-W	White Collar	Doz	12/48



WBS-W



WBS-R

CHROME-PLATED STEEL CHAMPAGNE BOTTLE STOPPER

- ◆ Keep the fizz and flavor in opened bottles

ITEM	DESCRIPTION	UOM	CASE
CBS-1	1-3/8"Dia	Each	72/288



CBS-1



BAR TRAYS



STRS-16

STAINLESS STEEL ROUND SERVING TRAYS

ITEM	DESCRIPTION	UOM	CASE
STRS-12	12" Dia	Each	12/48
STRS-14	14" Dia	Each	12/24
STRS-16	16" Dia	Each	12/24



TFG-16N

TFG-2622K



DELUXE FIBERGLASS NON-SLIP TRAYS

- ◆ High durability fiberglass tray with self-molded, peel-resistant, non-slip surface
- ◆ Dishwasher safe

ITEM	DESCRIPTION	SIZE	COLOR	UOM	CASE
TFG-11K	Round	11" Dia	Black	Each	1/12
TFG-11N	Round	11" Dia	Brown	Each	1/12
TFG-14K	Round	14" Dia	Black	Each	1/12
TFG-14N	Round	14" Dia	Brown	Each	1/12
TFG-16K	Round	16" Dia	Black	Each	1/12
TFG-16N	Round	16" Dia	Brown	Each	1/12
TFG-2622K	Oval	27"x 22"	Black	Each	1/6
TFG-2622N	Oval	27"x 22"	Brown	Each	1/6



TFG FIBERGLASS-SERIES



TRH-16

TRH-2722K

EASY-HOLD RUBBER-LINED PLASTIC TRAYS

- ◆ Non-slip surface
- ◆ Hand wash only

ITEM	DESCRIPTION	SIZE	COLOR	UOM	CASE
TRH-11	Round	11" Dia	Brown	Each	12
TRH-11K	Round	11" Dia	Black	Each	12
TRH-14	Round	14" Dia	Brown	Each	12
TRH-14K	Round	14" Dia	Black	Each	12
TRH-16	Round	16" Dia	Brown	Each	12
TRH-16K	Round	16" Dia	Black	Each	12
TRH-1418	Rectangle	18" x 14"	Brown	Each	12
TRH-1418K	Rectangle	18" x 14"	Black	Each	12
TRH-2722	Oval	27" x 22"	Brown	Each	1/6
TRH-2722K	Oval	27" x 22"	Black	Each	1/6



TRH PLASTIC-SERIES

CORK-LINED ROUND PLASTIC TRAYS

- ◆ Hand wash only



TCK-16

ITEM	DESCRIPTION	UOM	CASE
TCK-14	14" Dia	Each	12/48
TCK-16	16" Dia	Each	12/36
TCK-16CK	Replacement Cork for CK-16	Each	50/350

WINE SERVICE

4 QT STAINLESS STEEL WINE BUCKETS & STAND

- ◆ Long-lasting stainless steel, ideal for inside or outdoor tableside service
- ◆ Elegant mirror-finish for stylish display
- ◆ Easily transport wine buckets by the smooth knob or ring handles

ITEM	DESCRIPTION	SIZE	UOM	CASE
WB-4	4 Qt Wine Bucket, (No Retail Pkg)	7-1/2" Dia x 8" H	Each	6/24
WB-4HV	4 Qt Deluxe Wine Bucket	8" Dia x 10" H	Each	1/12
WB-29S	Pipe Style Stand* for WB-4 & WB-4HV	28-1/2" H	Each	1/6

*Assembly required



WB-4

WB-4HV

WB-29S

8 QT STAINLESS STEEL WINE BUCKET & STANDS

- ◆ Elegant mirror-finish for stylish display

ITEM	DESCRIPTION	UOM	CASE
WB-8	8 Qt Wine Bucket	Each	6/24
WB-8S	Stand* for WB-8	Each	1/12
WB-12FS	Folding Stand for WB-8	Each	1/6

*Assembly required



WB-12FS
Folded

WB-8S

WB-8

STAINLESS STEEL DOUBLE WALL WINE COASTERS

- ◆ Smooth or hammered satin-finish
- ◆ Fits 3-3/4" diameter wine bottles

ITEM	DESCRIPTION	SIZE	UOM	CASE
DWCC-5	Smooth Finish	4-5/8" Dia x 2-5/8"H	Each	12
DWCC-5H	Hammered Finish	4-5/8" Dia x 2-5/8"H	Each	12



DWCC-5H

DWCC-5

WINE COOLERS



ITEM	DESCRIPTION	SIZE	UOM	CASE
WC-60	Double Wall Hourglass, Mirror S/S	6" Dia x 7" H	Each	1/12
WC-7M	Marble, White	4 1/2" Dia x 7" H	Each	1/6
WC-5	Double Wall, Satin S/S (No Retail Pkg)	4 1/2" Dia x 7-3/4" H	Each	6/24
WC-4A	Acrylic, Clear	4 1/2" Dia x 9 1/4" H	Each	1/12



WC-60

WC-4A

WC-5

WC-7M



BAR LINERS & SERVICE MATS



NSF BM-327B



NSF BM-327K

RUBBER BAR RAIL SPILL MATS

- ◆ Protect the bar from spills
- ◆ Ideal length for big drink orders
- ◆ One-piece non-slip rubber

ITEM	DESCRIPTION	SIZE	UOM	CASE
BM-327B	Brown Mat	3-1/4" W x 27"L	Each	12/48
BM-327K	Black Mat	3-1/4" W x 27"L	Each	12/48



BM-1812B

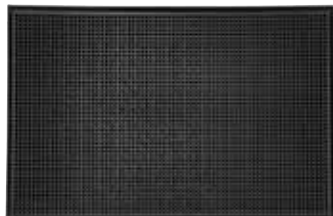

BM-1812K

NSF BM-SERIES

RUBBER BAR SERVICE MATS

- ◆ Catch spills, protect the bar, and keep glasses from sliding
- ◆ One-piece non-slip rubber

ITEM	DESCRIPTION	SIZE	UOM	CASE
BM-1812B	Brown Mat	12"W x 18"L	Each	12
BM-1812K	Black Mat	12"W x 18"L	Each	12



LIGHTWEIGHT INTERLOCKING SQUARE BAR MATS

- ◆ Cuts easily to fit any counter shape
- ◆ Dishwasher safe



BML-12C

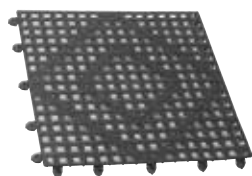

BML-12K

NSF BML-SERIES

ITEM	DESCRIPTION	SIZE	UOM	CASE
BML-12C	Clear Mat	12"W x 12"L	Each	12/24
BML-12K	Dark Smoke Mat	12"W x 12"L	Each	12/24

BAR LINER ROLLS

- ◆ 2' wide x 40' long per roll



ITEM	DESCRIPTION	SIZE	UOM	CASE
BL-240C	Clear Liner	2' W x 40' L	Each	2
BL-240G	Green Liner	2' W x 40' L	Each	2
BL-240K	Black Liner	2' W x 40' L	Each	2
BL-240R	Red Liner	2' W x 40' L	Each	2
BL-240W	White Liner	2' W x 40' L	Each	2

BPA FREE BL-SERIES



STAINLESS STEEL SPEED RAILS

- ◆ Keeps bar liquors and drink mixes close at hand
- ◆ Mounting straps sold separately

ITEM	DESCRIPTION	UOM	CASE
SPR-22S	22" Single	Each	1
SPR-22D	22" Double	Each	1/3
SPR-32S	32" Single	Each	1
SPR-32D	32" Double	Each	1/3
SPR-42S	42" Single	Each	1
SPR-42D	42" Double	Each	1/3
SPR-1	Mounting Straps for SPR-series	Each	12/120

Keep a neat, tidy, and efficient bar

SPEED RAILS



SPR-22S



SPR-22D



SPR-1

BAR MAID® POLYETHYLENE BOTTLE WELLS

- ◆ Contain drips from liquor bottles or mixer containers
- ◆ Fits in the bar ice bin or speed rail



ITEM	DESCRIPTION	UOM	CASE
CR-2400	Round, Black	Each	1/40
CR-2401	Square, Black	Each	1/40



CR-2400



CR-2401



OVERHEAD GLASS RACKS



MULTI-CHANNEL GLASS HANGERS

- ◆ Chrome-plated sturdy wire

ITEM	DESCRIPTION	SIZE	UOM	CASE
GHC-1836	8 Channels	18" x 36" x 4"	Each	2/4
GHC-1848	11 Channels	18" x 48" x 4"	Each	2/4

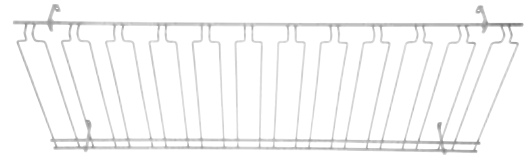

GHC-1848

SINGLE-CHANNEL GLASS HANGERS

- ◆ 3 lengths available in chrome or brass-plated

ITEM	DESCRIPTION	SIZE	UOM	CASE
GH-10	Brass Plated	10"	Each	12/72
GH-16	Brass Plated	16"	Each	12/72
GH-24	Brass Plated	24"	Each	12/48
GHC-10	Chrome Plated	10"	Each	12/72
GHC-16	Chrome Plated	16"	Each	12/72
GHC-24	Chrome Plated	24"	Each	12/48



GH-16



GHC-16





- ✓ **SAVES TIME**
- ✓ **SAVES LABOR**
- ✓ **MORE VERSATILITY**
- ✓ **MORE PROFIT**

GLASS WASHERS



A-200



A-200 & A-205-P

- ◆ Five spinning brushes (four 6" brushes and one 6-3/4" center brush) clean inside and out simultaneously for crystal clear glassware



BAR MAID® GLASS WASHERS

- ◆ Quiet, powerful 1/3 HP enclosed motor with sealed lower bearing and exclusive Splashguard canopy
- ◆ Automatic overload safety & ground fault protection plug
- ◆ Heavy bronze bearings and stainless steel construction

ITEM	OVERALL DIMENSIONS L" x D" x H" (mm)	POWER	PLUG	SHIP WEIGHT
A-200	12 x 8 x 18 (305 x 203 x 457)	115V-60Hz, 440W, 4.3A,	NEMA 5-15P, G.F.C.I. included	27 lbs (12.2 kgs)
A-205-P		*220-230V~ 50/60Hz,	Type E, G.F.C.I. not included	23 lbs (10.4 kgs)



ITEM	DESCRIPTION	UOM	CASE
A-200	Upright Glass Washer, 115V	Box	1
A-205-P	Upright Glass Washer, 220V, International	Box	1



SS-100



SS-100



BAR MAID® SUBMERSIBLE GLASS WASHER

- ◆ Compact design fits under bars even if space is tight
- ◆ Heavy-duty stainless steel construction and bronze bearings deliver outstanding performance and reliability
- ◆ Submersible 1/3 HP motor with automatic overload and ground fault protection plug

ITEM	OVERALL DIMENSIONS L" x D" x H" (mm)	POWER	PLUG	SHIP WEIGHT
SS-100	12 x 8 x 12 (305 x 203 x 305)	115V-60Hz, 440W, 4.3A,	NEMA 5-15P, G.F.C.I. included	27 lbs (12.2 kgs)



ITEM	DESCRIPTION	UOM	CASE
SS-100	Submersible Glass Washer, 115V	Box	1



NOTHING CLEANS GLASSWARE FASTER OR BETTER



- ◆ Five spinning brushes (four 6" brushes and one 6-3/4" center brush) clean inside and out simultaneously for crystal clear glassware



BAR MAID® GLASS PRO GLASS WASHER

- ◆ Heavy duty stainless steel construction
- ◆ 1/3 HP motor with automatic overload and ground fault protection plug

ITEM	OVERALL DIMENSIONS L" x D" x H" (mm)	POWER	PLUG	SHIP WEIGHT
AA	12 x 8 x 17-3/4 (305 x 203 x 450)	115V-60Hz, 440W, 4.3A	NEMA 5-15P, G.F.C.I. included	27 lbs (12.2 kgs)



ITEM	DESCRIPTION	UOM	CASE
AA	Upright Glass Washer, 115V	Box	1



GLASS WASHERS



AA-SERIES



BAR MAID® GLASS PRO SUBMERSIBLE GLASS WASHER

ITEM	OVERALL DIMENSIONS L" x D" x H" (mm)	POWER	PLUG	SHIP WEIGHT
AA-SUB	12 x 8 x 11 (305 x 203 x 280)	115V-60Hz, 440W, 4.3A	NEMA 5-15P, G.F.C.I. included	27 lbs (12.2 kgs)



ITEM	DESCRIPTION	UOM	CASE
AA-SUB	Submersible Glass Pro Glass Washer, 115V	Box	1



AA-SERIES





- ✓ **SAVES TIME**
- ✓ **SAVES LABOR**
- ✓ **MORE VERSATILITY**
- ✓ **MORE PROFIT**

GLASS CLEANERS



DIS-207

BAR MAID® SANI-MAID DISINFECTANT, SANITIZER AND DEODORANT TABLETS

A multi-use germicidal disinfectant, sanitizer and true deodorant.

- ◆ Dissolves instantly in warm or cold water
- ◆ Use one tablet per gallon for 200 ppm or two tablets per gallon for 400 ppm
- ◆ Does not harm any surface not harmed by water
- ◆ Controls odors
- ◆ No chlorine taste or odor
- ◆ 200 tablets per bottle

ITEM	DESCRIPTION	UOM	CASE
DIS-207	Quaternary Sanitizer/Disinfectant Tablets, 4 Bottles	Box	1/12



DET-1200

BAR MAID® LOSUDS LIQUID CONCENTRATE

Liquid glassware detergent for electric and manual glass washers effectively removes stains, residue, and contaminants without leaving streaks or spots. Excellent in all types of water and easy on hands.

- ◆ Cuts grease and oil for spotless glassware
- ◆ Save money – 1/4 ounce to 3 gallons of water is all you need for sparkling clean glassware
- ◆ 128 applications per 1 quart bottle

ITEM	DESCRIPTION	UOM	CASE
DET-1200	LoSuds Concentrate, (12) 1 Qt Bottles Per Case	Each	12



DIS-302



DIS-202

BAR MAID® SANITIZER STRIPS

Ensure your dishes and glassware are properly sanitized.

- ◆ Convenient dispenser saves unused strips from damage
- ◆ Approximately 100 strips per dispenser
- ◆ 12 dispensers per display box



DIS-303

ITEM	DESCRIPTION	UOM	CASE
DIS-202	Quaternary Strips in Roll	Box	1/100
DIS-302	Chlorine Strips in Roll	Box	1/50
DIS-303	Chlorine Strips in Vial	Each	1/500



DIS-402

BAR MAID® PH TEST STRIPS

Monitor water quality in food service applications. Simply dip pH test strip in a solution and compare to color chart on package.

- ◆ Convenient dispenser saves unused strips from damage
- ◆ 3 – 5.5 range for food service applications
- ◆ Approximately 100 per dispenser

ITEM	DESCRIPTION	UOM	CASE
DIS-402	pH Test Strips in Dispenser	Each	1/12

GENTLE, EFFECTIVE CLEANING



BAR MAID® GLASS WASHER BRUSHES

ITEM	DESCRIPTION	TYPE	UOM	CASE
BRS-732SG	Shot Glass Brush	Pinned	Each	1/18
BRS-980	4" Scrub Brush, For Muffin Pans	Pinned	Each	1/6
BRS-917	6" Standard Brush	Pinned	Each	1/18
BRS-920	6-3/4", For Slightly Taller Glassware	Pinned	Each	1/18
BRS-922	7-1/2", For Taller Glassware	Pinned	Each	1/18
BRS-975	8-1/2", For Extra Tall Glassware	Pinned	Each	1/18
BRS-975S	8-1/2" Softie® Brush, For Delicate Extra-Tall Glassware	Pinned	Each	1/18
BRS-976	9" Pilsner Brush	Pinned	Each	1/18
BRS-950	Margarita & Martini Glass Brush	Pinned	Each	1/6
BRS-930	Wide Coffee Pot & Pitcher Brush	Pinned	Each	1/6
BRS-935	Narrow Top Coffee Pot Brush	Pinned	Each	1/18

Measurement is the "usable" length of the brush

GLASS WASHER BRUSHES



BRS-980

BRS-732SG



BRS-920

BRS-922

BRS-975

BAR MAID® GLASS WASHER BRUSH SETS

ITEM	DESCRIPTION	TYPE	UOM	CASE
BRS-1722	Replacement Brush Set Includes (4) 6" Standard Brushes & (1) 7-1/2" For Taller Glassware Brush. Fits all Bar Maid models	Pinned	Box	1/6
BRS-1720SL	Replacement Universal Brush Set Includes (4) 6" Standard Brushes & (1) 6-3/4" Brush for Slightly Taller Glassware	Slotted	Box	1/6



BRS-976

BRS-950



BRS-930

BRS-935



BRS-1722





GENTLE, EFFECTIVE CLEANING

GLASS WASHING BRUSHES & WAND



BAR MAID® GLASS WASHING BRUSHES

- ◆ Synthetic bristles gently & thoroughly clean glassware
- ◆ Full suction base holds securely to surfaces
- ◆ Dishwasher safe

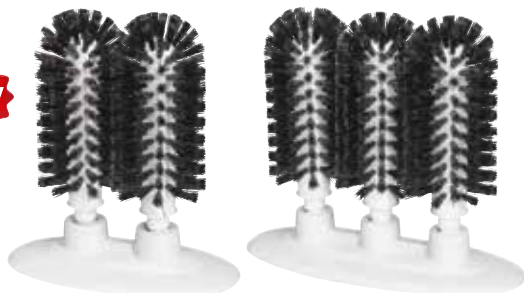

GWM-200

GWM-300

ITEM	DESCRIPTION	UOM	CASE
GWM-200	2 Brushes with Suction Cup Base 8"H x 7-1/2"W	Box	1/6
GWM-300	3 Brushes with Suction Cup Base, 8"H x 9-1/2"W	Box	1/6



GWB-3



GWB-3-BR

GLASS WASHING BRUSHES

- ◆ Synthetic bristles gently & thoroughly clean glassware
- ◆ Base with suction feet holds securely to surfaces
- ◆ Dishwasher safe

ITEM	DESCRIPTION	UOM	CASE
GWB-3	3 Brushes with Base	Each	1/12
GWB-3-BR	Brush for GWB-3	Each	1/100



GP-1M



GP-3MC

BAR MAID® GLASS POLISHING WAND

- ◆ Flexible wand tip contours to shape of glass for reduced stress and gentle polishing
- ◆ Included cloth sleeve is lint-free and washable



ITEM	DESCRIPTION	UOM	CASE
GP-1M	Manual Polishing Wand	Each	1/35
GP-3MC	Polishing Wand Replacement Cloths, 3-pcs/pk	Pack	1/6

Lint-free shine

FLY-BYE™ FRUIT FLY TRAPS



BAR MAID® FLY-BYE™ FRUIT FLY TRAPS

Say goodbye to pesky fruit flies.

- ◆ Utilizes a 2-part, food-based attractant to entice fruit flies into the trap where they are unable to escape.
- ◆ Non-toxic use anywhere, any time - contains no VOCs (Volatile Organic Compounds)
- ◆ Each trap lasts up to 30 days and is recyclable



FLY-BYE

ITEM	DESCRIPTION	UOM	CASE
FLY-BYE	Fruit Fly Traps, 2-pcs/pk, 6-packs/case	Case	1

- ✔ **EFFORTLESS**
- ✔ **VERSATILE**
- ✔ **COMPACT**



- ◆ Versatile: move a variety of heavy or bulky items
- ◆ Less effort required: allows a broader range of employees to manage and move heavy items without strain
- ◆ Reduces risk of injury: helps prevent employee injury claims and time lost
- ◆ MADE IN USA



KEG CART & DOLLY



KPC-100

BAR MAID® KEG & PAIL CART

Easily move heavy kegs, stock pots, 5 gallon pails up stairs and over thresholds.

- ◆ Heavy duty powder-coated metal construction
- ◆ Ergonomically designed to virtually eliminate potential back strain
- ◆ 8" non-marking wheels with steel roller bearings

ITEM	DESCRIPTION	UOM	CASE
KPC-100	Keg & Pail Cart	Case	1

**Roll up, hook on,
take it away - easy!**



Easy for anyone to use

BAR MAID® KEG & PAIL DOLLY

- ◆ Sturdy all-metal construction
- ◆ 400 lbs load capacity
- ◆ 5 smooth-swivel casters
- ◆ Also can transport most sizes of trash containers

ITEM	DESCRIPTION	UOM	CASE
DOL-100	Keg & Pail Dolly	Case	1



DOL-100





GENTLE, EFFECTIVE CLEANING

FLY-BYE™ TAP CAPS



TAP-CAP



TAP-BRUSH



BAR MAID® FLY-BYE™ TAP CAP BRUSHES AND CAPS

- ◆ Keeps fruit flies and bugs out and taps sanitary
- ◆ Brushes help remove built up residue inside taps, prevent "beer stone" and bacteria build up
- ◆ Stepped design fits virtually all taps

ITEM	DESCRIPTION	UOM	CASE
TAP-BRUSH	Tap Brush, 6-pcs/pk	Pack	1/48
TAP-BRUSH50	Tap Brush, 50-pcs/pk	Pack	1
TAP-CAP	Tap Cap, 12-pcs/pk	Box	1/30

DRAIN TRAYS & TRAPS



CR-700



CR-701



Snug fitting rubber



OP-7



OP-11

BAR MAID® DRAIN TRAYS & EXTENSIONS

- ◆ Drain tray includes drain tube
- ◆ Use drain extensions with funnel or tray

ITEM	DESCRIPTION	UOM	CASE
CR-760	Drain Tray with Drain Tube, Black, 14"L x 5"W x 3"D	Each	1/12
CR-759	Replacement Drain Tube For Drain Tray	Each	1
CR-700	Superb Seal Bar Drain Extensions 8" Fits 1" To 1-3/8" Drain	Each	1/240
CR-701	Superb Seal Bar Drain Extensions 10" Fits 1-1/4" To 1-3/4" Drain	Each	1/144



CR-760



CR-759

STANDARD SINK OVERFLOW PIPES

- ◆ Polypropelene with rubber cap for snug fit in sink drain
- ◆ Designed to keep water level below rim of 8" or higher sink, preventing spills - especially helpful in busy bar sinks

ITEM	DESCRIPTION	UOM	CASE
OP-7	7"L x 1"Dia	Each	24/288
OP-11	11"L x 1"Dia	Each	12/144



FB-TS20



FB-TS30



FB-TS35



FB-TS40



BAR MAID® FLY-BYE™ FLOOR DRAIN TRAP SEALS

- ◆ Patented one-way valve allows fluid to flow down without impeding flow rate and lets nothing come back up
- ◆ Makes drains virtually maintenance free
- ◆ Effectively stops fruit flies and insects from coming up
- ◆ Acts as a vapor barrier to keep bacteria, odors, and gases in the drain for improved indoor air quality
- ◆ No need to add primers and fresh water
- ◆ Pesticide-free, No VOCs

ITEM	DESCRIPTION	UOM	CASE
FB-TS20	For 2" Drain Pipes	Box	1/12
FB-TS30	For 3" Drain Pipes	Box	1/12
FB-TS35	For 3.5" Drain Pipes	Box	1/6
FB-TS40	For 4" Drain Pipes	Box	1/6

MICROFIBER TOWEL ROLL & HOLDER

At a moment's notice, tear individual microfiber towels right from a compact towel roll.

- ◆ Quick access, quick dispensing, space efficient
- ◆ Non-scratch and lint-free
- ◆ 12" x 12" sheets; 50 sheets per roll

ITEM	DESCRIPTION	UOM	CASE
BTM-12B	Blue Towel Roll	Pack	12
WHW-12	Towel Holder, White	Each	6/24

BAR CLEAN-UP



BTM-12B



BTM-12B with WHW-12

MICROFIBER TOWELS

Removes more bacteria than regular cotton cleaning cloths. Each pack includes hanging hook.

- ◆ Lightweight, absorbent, and quick drying
- ◆ BTM-16AC: yellow, blue, white, green, orange, red
- ◆ 6 towels per pack

ITEM	DESCRIPTION	UOM	CASE
BTM-16AC	Assorted Colors	Pack	1/20
BTM-16B	Blue	Pack	1/20
BTM-16G	Green	Pack	1/20
BTM-16R	Red	Pack	1/20
BTM-16W	White	Pack	1/20



NEW COLORS



BTM-16AC

COTTON GLASS POLISHING TOWEL

- ◆ Absorbent 100% cotton
- ◆ Lint-free and non-abrasive, gentle on glassware & non-streaking
- ◆ Effectively picks up dirt and dust
- ◆ Red stripe towel can be designated for a specific station or to prevent cross-contamination

ITEM	DESCRIPTION	UOM	CASE
BTGP-21	16" x 29"	Doz	10/20



BTGP-21

COTTON-BLEND HERRINGBONE BAR TOWEL

- ◆ Absorbent 70% cotton/30% poly
- ◆ Ideal for wiping down bar top, tables or countertops
- ◆ Green stripe towel can be designated for a specific station or to prevent cross-contamination

ITEM	DESCRIPTION	UOM	CASE
BTH-2028G	20" x 28"	Doz	10/20



BTH-2028G

WHITE COTTON BAR TOWEL

- ◆ 100% cotton

ITEM	DESCRIPTION	UOM	CASE
BTW-30	16" x 19"	Doz	10/20



BTW-30

PLASTIC SPRAY BOTTLES

Durable easy-spray color-coded bottles for effective spot cleaning and sanitizing.

- ◆ Adjustable spray nozzle with two settings: Mist and Stream
- ◆ Easy-read gradation marks indicate capacity level
- ◆ Use with cleaning and chemical solutions

ITEM	DESCRIPTION	UOM	CASE
PSR-9	Green, 28 oz (828ml)	Each	50
PSR-9B	Blue, 28 oz (828ml)	Each	50
PSR-9R	Red, 28 oz (828ml)	Each	50
PSR-9W	White, 28 oz (828ml)	Each	50
PSR-9Y	Yellow, 28 oz (828ml)	Each	50



PSR-9Y PSR-9W PSR-9R PSR-9B PSR-9

KITCHEN Prep & Cook



REUSABLE & ADJUSTABLE 2-PLY FACE MASKS

- ◆ Outer: 100% Polyester, Lining: 60/40 Cotton/Poly
- ◆ Machine washable
- ◆ Non-medical grade
- ◆ Comfort fit with contoured nose
- ◆ Adjustable soft elastic ear loops for lasting comfort

ITEM	COLOR	SIZE	UOM	CASE
MSK-3ML	Camo	M/L	2 Pcs/Pk	50/250
MSK-3LXL	Camo	L/XL	2 Pcs/Pk	50/250
MSK-4GML	Gray	M/L	2 Pcs/Pk	50/250
MSK-4GLXL	Gray	L/XL	2 Pcs/Pk	50/250



REUSABLE FACE MASKS

Great Quality. Great Value.

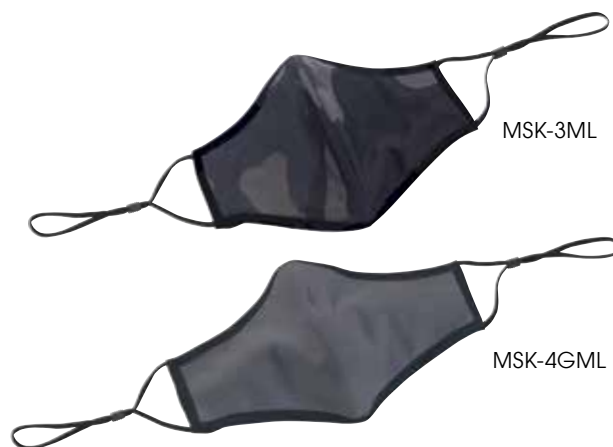

REUSABLE & ADJUSTABLE 2-PLY FACE MASKS

- ◆ 100% Cotton
- ◆ Machine washable
- ◆ Non-medical grade
- ◆ Comfort fit with contoured nose
- ◆ Adjustable soft elastic ear loops for lasting comfort

ITEM	COLOR	SIZE	UOM	CASE
MSK-2WML	White	M/L	2 Pcs/Pk	50/250
MSK-2WLXL	White	L/XL	2 Pcs/Pk	50/250
MSK-2KML	Black	M/L	2 Pcs/Pk	50/250
MSK-2KLXL	Black	L/XL	2 Pcs/Pk	50/250



REUSABLE 2-PLY FACE MASKS

- ◆ 100% Cotton
- ◆ Machine washable
- ◆ Non-medical grade
- ◆ Comfort fit with contoured nose
- ◆ Soft elastic ear loops for lasting comfort

ITEM	COLOR	SIZE	UOM	CASE
MSK-1WML	White	M/L	2 Pcs/Pk	50/250
MSK-1WLXL	White	L/XL	2 Pcs/Pk	50/250
MSK-1KML	Black	M/L	2 Pcs/Pk	50/250
MSK-1KLXL	Black	L/XL	2 Pcs/Pk	50/250



! Wash before wearing. Face coverings are not intended for medical use, and not proven to reduce the transmission of disease. Masks are intended for ADULT USE ONLY. They should not be placed on children under age 2, used by anyone with skin sensitivities, who has trouble breathing, or who is unconscious, incapacitated, or otherwise unable to remove the mask without assistance.



THE SIGNATURE LOOK

Great Quality. Great Value.

Built tough to stand up to the demands of the commercial kitchen, **Signature Chef by Winco®** mixes all the right ingredients in chef apparel, fit for any budget.

CHEF JACKETS



TAPERED FIT VENTILATED CHEF JACKETS - WHITE OR BLACK

- ◆ Cool mesh panels on back, sides and underarms
- ◆ Roll-up sleeves with one-button tab
- ◆ Left sleeve thermometer pocket
- ◆ 65/35 poly-cotton blend
- ◆ Available in white or black

◆ Color display box only available with full case (FC) qty

Refer to sizing guide following chef hats



ITEM	COLOR	SIZE	UOM	CASE
UNF-12WS	White	S	Each	12/24
UNF-12WM	White	M	Each	12/24
UNF-12WL	White	L	Each	12/24
UNF-12WXL	White	XL	Each	12/24
UNF-12WXXL	White	2X	Each	12/24
UNF-12W3XL	White	3X	Each	12/24
UNF-12KS	Black	S	Each	12/24
UNF-12KM	Black	M	Each	12/24
UNF-12KL	Black	L	Each	12/24
UNF-12KXL	Black	XL	Each	12/24
UNF-12KXXL	Black	2X	Each	12/24
UNF-12K3XL	Black	3X	Each	12/24



UNF-12WM

Wear sleeves long or rolled up



UNF-12KM



Ventilated back, both sides and underarms



UNIVERSAL FIT CHEF JACKETS - WHITE

- ◆ Double breasted, with thermometer/pen pocket & chest pocket
- ◆ 65/35 poly-cotton blend
- ◆ Available in white

◆ Color display box only available with full case (FC) qty

Refer to sizing guide following chef hats



ITEM	COLOR	SIZE	UOM	CASE
UNF-5WS	White	S	Each	12/24
UNF-5WM	White	M	Each	12/24
UNF-5WL	White	L	Each	12/24
UNF-5WXL	White	XL	Each	12/24
UNF-5WXXL	White	2X	Each	12/24
UNF-5W3XL	White	3X	Each	12/24



UNF-5WM





MEN'S TAPERED FIT CHEF JACKETS - RED, WHITE, BLACK CHEF JACKETS



- ◆ Double breasted with thermometer/pen pocket
- ◆ 65/35 poly-cotton blend
- ◆ Available in red, white or black

◆ Color display box only available with full case (FC) qty

Refer to sizing guide following chef hats



ITEM	COLOR	SIZE	UOM	CASE
UNF-6RS	Red	S	Each	12/24
UNF-6RM	Red	M	Each	12/24
UNF-6RL	Red	L	Each	12/24
UNF-6RXL	Red	XL	Each	12/24
UNF-6RXXL	Red	2X	Each	12/24
UNF-6WS	White	S	Each	12/24
UNF-6WM	White	M	Each	12/24
UNF-6WL	White	L	Each	12/24
UNF-6WXL	White	XL	Each	12/24
UNF-6WXXL	White	2X	Each	12/24
UNF-6W3XL	White	3X	Each	12/24
UNF-6W4XL	White	4X	Each	12/24
UNF-6KS	Black	S	Each	12/24
UNF-6KM	Black	M	Each	12/24
UNF-6KL	Black	L	Each	12/24
UNF-6KXL	Black	XL	Each	12/24
UNF-6KXXL	Black	2X	Each	12/24
UNF-6K3XL	Black	3X	Each	12/24
UNF-6K4XL	Black	4X	Each	12/24

Individually packaged in printed poly-bag



Color box with full case purchase



UNF-6RM



UNF-6WM

UNF-6KM



WOMEN'S TAPERED FIT CHEF JACKETS - WHITE OR BLACK

- ◆ Double breasted with thermometer/pen pocket
- ◆ 65/35 poly-cotton blend
- ◆ Available in white or black

◆ Color display box only available with full case (FC) qty

Refer to sizing guide following chef hats



ITEM	COLOR	SIZE	UOM	CASE
UNF-7WS	White	S	Each	12/24
UNF-7WM	White	M	Each	12/24
UNF-7WL	White	L	Each	12/24
UNF-7KS	Black	S	Each	12/24
UNF-7KM	Black	M	Each	12/24
UNF-7KL	Black	L	Each	12/24

Individually packaged in printed poly-bag



Color box with full case purchase



UNF-7WM



UNF-7KM



VENTILATED SHIRTS



TAPERED FIT VENTILATED SHIRTS - WHITE OR BLACK

- ◆ Cool mesh panels on back, sides and underarms
- ◆ Wide chest pocket & double thermometer/pen pocket
- ◆ Lightweight 65/35 poly-cotton blend
- ◆ Available in white or black

◆ Color display box only available with full case (FC) qty

Refer to sizing guide following chef hats



ITEM	COLOR	SIZE	UOM	CASE
UNF-9WS	White	S	Each	18/36
UNF-9WM	White	M	Each	18/36
UNF-9WL	White	L	Each	18/36
UNF-9WXL	White	XL	Each	18/36
UNF-9WXXL	White	2X	Each	18/36
UNF-9W3XL	White	3X	Each	18/36
UNF-9KS	Black	S	Each	18/36
UNF-9KM	Black	M	Each	18/36
UNF-9KL	Black	L	Each	18/36
UNF-9KXL	Black	XL	Each	18/36
UNF-9KXXL	Black	2X	Each	18/36
UNF-9K3XL	Black	3X	Each	18/36



UNF-9WM

Ventilated back, sides and underarms

Cool Mesh



Individually packaged in printed poly-bag



Color box with full case purchase



UNF-9KM

Ventilated back, sides and underarms

SNAP-BUTTON SHIRTS



SNAP-BUTTON SHIRTS - WHITE OR BLACK

- ◆ Short-sleeved chef shirts feature a chest pocket and snap-button fasteners
- ◆ Lightweight 65/35 poly-cotton blend
- ◆ Available in white or black

◆ Color display box only available with full case (FC) qty

Refer to sizing guide following chef hats



ITEM	COLOR	SIZE	UOM	CASE
UNF-1WS	White	S	Each	24/48
UNF-1WM	White	M	Each	24/48
UNF-1WL	White	L	Each	24/48
UNF-1WXL	White	XL	Each	24/48
UNF-1WXXL	White	2X	Each	24/48
UNF-1W3XL	White	3X	Each	24/48
UNF-1W4XL	White	4X	Each	24/48
UNF-1KS	Black	S	Each	24/48
UNF-1KM	Black	M	Each	24/48
UNF-1KL	Black	L	Each	24/48
UNF-1KXL	Black	XL	Each	24/48
UNF-1KXXL	Black	2X	Each	24/48
UNF-1K3XL	Black	3X	Each	24/48
UNF-1K4XL	Black	4X	Each	24/48

Individually packaged in printed poly-bag



Color box with full case purchase



UNF-1WM



UNF-1KM

WOMEN'S CHEF PANTS - BLACK

- ◆ Solid black, straight-leg
- ◆ Elastic drawstring waist
- ◆ Two front pockets
- ◆ 65/35 poly-cotton blend
- ◆ Color display box only available with full case (FC) qty

Refer to sizing guide following chef hats

S M L

ITEM	COLOR	SIZE	UOM	CASE
UNF-8KS	Black	S	Each	12/24
UNF-8KM	Black	M	Each	12/24
UNF-8KL	Black	L	Each	12/24

BLACK PANTS

Individually packaged in printed poly-bag



Color box with full case purchase



UNF-8KM

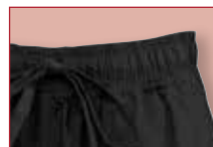

Elastic drawstring waist

CARGO CHEF PANTS - BLACK

- ◆ Solid black, universal fit
- ◆ Elastic drawstring waist
- ◆ Cargo pockets with velcro closure
- ◆ 65/35 poly-cotton blend
- ◆ Color display box only available with full case (FC) qty

Refer to sizing guide following chef hats

XS S M L XL 2X

ITEM	COLOR	SIZE	UOM	CASE
UNF-11KXS	Black	XS	Each	12/24
UNF-11KS	Black	S	Each	12/24
UNF-11KM	Black	M	Each	12/24
UNF-11KL	Black	L	Each	12/24
UNF-11KXL	Black	XL	Each	12/24
UNF-11KXXL	Black	2X	Each	12/24

Individually packaged in printed poly-bag



Color box with full case purchase



UNF-11KM



Cargo pockets with velcro closure

CHEF PANTS - BLACK

- ◆ Relaxed, universal fit; elastic drawstring waist
- ◆ Two side-seam pockets
- ◆ 65/35 poly-cotton blend
- ◆ Color display box only available with full case (FC) qty

Refer to sizing guide following chef hats

S M L XL 2X

ITEM	COLOR	SIZE	UOM	CASE
UNF-2KS	Black	S	Each	12/24
UNF-2KM	Black	M	Each	12/24
UNF-2KL	Black	L	Each	12/24
UNF-2KXL	Black	XL	Each	12/24
UNF-2KXXL	Black	2X	Each	12/24

Individually packaged in printed poly-bag



Color box with full case purchase



UNF-2KM



Elastic drawstring waist

PATTERNED PANTS



CHEF PANTS - WOVEN CHALKSTRIPE

- ◆ Relaxed, universal fit; elastic drawstring waist
- ◆ Two side-seam pockets
- ◆ 65/35 poly-cotton blend
- ◆ Color display box only available with full case (FC) qty

Refer to sizing guide following chef hats



- S M L XL 2X

ITEM	COLOR	SIZE	UOM	CASE
UNF-3CS	Chalkstripe	S	Each	12/24
UNF-3CM	Chalkstripe	M	Each	12/24
UNF-3CL	Chalkstripe	L	Each	12/24
UNF-3CXL	Chalkstripe	XL	Each	12/24
UNF-3CXXL	Chalkstripe	2X	Each	12/24



UNF-3CM



Woven pattern



Elastic drawstring waist



CHEF PANTS - HOUNDSTOOTH

- ◆ Relaxed, universal fit; elastic waistband with inner drawstring
- ◆ Two side-seam pockets
- ◆ 65/35 poly-cotton blend
- ◆ Color display box only available with full case (FC) qty

Refer to sizing guide following chef hats



- S M L XL 2X

ITEM	COLOR	SIZE	UOM	CASE
UNF-4KS	Houndstooth	S	Each	12/24
UNF-4KM	Houndstooth	M	Each	12/24
UNF-4KL	Houndstooth	L	Each	12/24
UNF-4KXL	Houndstooth	XL	Each	12/24
UNF-4KXXL	Houndstooth	2X	Each	12/24



UNF-4KM

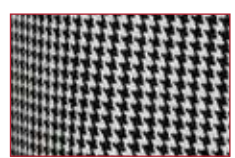

Pattern

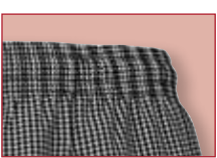

Elastic waistband, inner drawstring



BIB APRONS



HEAVYWEIGHT DENIM BIB APRON, CROSS-BACK

Stylish and functional, the dark wash denim masks spills and stains while keeping up appearances.

- ◆ 80/20 cotton-poly blend dark wash denim
- ◆ Contrast stitching and brass rivet details
- ◆ Cross-back straps adjust for best fit
- ◆ Two (2) slanted waist pockets
- ◆ Thermometer/pen pocket
- ◆ 31-3/4"L x 26-3/4"W
- ◆ Color display box only available with full case (FC) qty

ITEM	COLOR	UOM	CASE
BADN-3126	Dark Wash w/Brown Straps	Each	12/24



Cross-back



Leather strap divider



BADN-3126

Individually packaged in printed poly-bag



Color box with full case purchase

HEAVYWEIGHT DENIM BIB APRON, ADJUSTABLE NECK

Hard-wearing style that can handle the hustle. Adjust the neck strap to achieve the perfect length.

- ◆ 80/20 cotton-poly blend dark wash denim
- ◆ Adjustable neck accommodates most heights
- ◆ Two (2) vertical waist pockets
- ◆ Open chest pocket
- ◆ Zippered cell-phone pocket
- ◆ 34-1/2"L x 30-1/4"W
- ◆ Color display box only available with full case (FC) qty

ITEM	COLOR	UOM	CASE
BADN-3430	Dark Wash w/Gray Straps	Each	12/24



Adjustable neck strap



BADN-3430

BIB APRONS



MID-WEIGHT BIB APRONS

The perfect addition to uniforms calling for a streamlined look.

- ◆ Blue apron is 65/35 poly-cotton blend
- ◆ Black apron is 80/20 poly-cotton blend
- ◆ Adjustable snap-button neck strap for the best fit
- ◆ Thermometer/pen pocket
- ◆ Eight (8) varying size waist pockets to hold supplies
- ◆ 33-1/2"L x 27"W

◆ Color display box only available with full case (FC) qty



BA-3327B
Model: 5' 3"



BA-3327K

ITEM	COLOR	UOM	CASE
BA-3327B	Blue	Each	24/48
BA-3327K	Black	Each	24/48



Adjustable neck strap

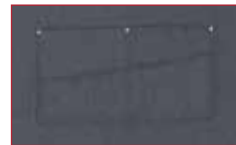

8 pockets at waist



Individually packaged in printed poly-bag

Color box with full case purchase

INDIVIDUALLY PACKAGED IN PRINTED POLY-BAG



WOVEN CHALKSTRIPE BIB APRON

The stripe pattern of this bib apron is woven in, making for a lasting appearance that stands up to busy service and bartending shifts.

- ◆ 65/35 poly-cotton blend
- ◆ Two (2) waist pockets; designed to hold digital tablets up to 8" wide
- ◆ 33-1/2"L x 27"W

ITEM	DESCRIPTION	UOM	CASE
BA-3427CS	Chalkstripe w/Pockets	Each	12/60



BA-3427CS



Model: 6'



Woven pattern

INDIVIDUALLY PACKAGED IN PRINTED POLY-BAG



3-POCKET MID-LENGTH BIB APRONS

- ◆ 65/35 poly-cotton blend
- ◆ Adjustable neck strap
- ◆ 24"L x 27-1/2"W

ITEM	COLOR	UOM	CASE
BA-2724W	White	Each	12/60
BA-2724K	Black	Each	12/60



BA-2724W



BA-2724K
Model: 5' 3"

FULL-LENGTH BIB APRONS

- ◆ Pen and pad pockets on select items
- ◆ Cotton-poly blend, machine wash and dry; wrinkle-resistant
- ◆ Assorted colors available
- ◆ 33"L x 26"W

ITEM	DESCRIPTION	UOM	CASE
BA-3226WH	White, No Pockets	Each	12/60
BA-3226BK	Black, No Pockets	Each	12/60
BA-PBG	Burgundy, w/Pockets	Each	12/60
BA-PBK	Black, w/Pockets	Each	12/60
BA-PBL	Blue, w/Pockets	Each	12/60
BA-PGN	Green, w/Pockets	Each	12/60
BA-PLG	Light Green, w/Pockets	Each	12/60
BA-PRD	Red, w/Pockets	Each	12/60
BA-PWH	White, w/Pockets	Each	12/60



Available Colors

BA-SERIES, WITH PEN & PAD POCKETS

WAIT SERVICE APRONS



BA-SERIES, WITHOUT POCKETS



BA-PBL
Model: 6'

INDIVIDUALLY
PACKAGED IN
PRINTED POLY-BAG

BISTRO FULL LENGTH APRONS

These full length bistro/waist aprons are a versatile addition to staff uniforms, easily transitioning from casual to formal, all with a polished look.

- ◆ 65/35 poly-cotton blend
- ◆ Two (2) large utility pockets; fits most digital tablets

ITEM	DESCRIPTION	UOM	CASE
WA-3129WH	White	Each	12/60
WA-3129BK	Black	Each	12/60



WA-3129BK

WA-3129WH

INDIVIDUALLY
PACKAGED IN
PRINTED POLY-BAG

BISTRO HALF LENGTH APRONS

Simple and crisp, the half length bistro aprons are adaptable across a multitude of settings.

- ◆ 65/35 poly-cotton blend
- ◆ Two (2) utility pockets; fits most digital tablets
- ◆ 19"L x 28"W

ITEM	DESCRIPTION	UOM	CASE
WA-2819W	White	Each	12/60
WA-2819K	Black	Each	12/60



WA-2819K

WA-2819W

SERVICE APRONS



4 aprons
in one

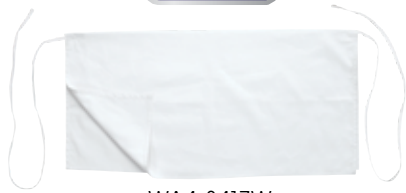

WA4-3417W



WA4-3417K

FOUR-WAY APRONS

These aprons offer four (4) surfaces for a quick-flip change to present a clean side on the fly, without the need for switching to a new apron.

- ◆ 65/35 poly-cotton blend
- ◆ 17"L x 34"W

ITEM	DESCRIPTION	UOM	CASE
WA4-3417W	White	Each	12/60
WA4-3417K	Black	Each	12/60



Models (L to R): 6' / 5' 3" / 5' 7"

INDIVIDUALLY
PACKAGED IN
PRINTED POLY-BAG

3-POCKET WAIST APRONS

- ◆ Cotton-poly blend, machine wash and dry, wrinkle resistant
- ◆ Available in four (4) colors
- ◆ 12-1/2"L x 21-3/4"W



WA-1221



WA-1221R



WA-1221G



WA-1221RED

ITEM	DESCRIPTION	UOM	CASE
WA-1221	Black	Each	12/60
WA-1221G	Green	Each	12/60
WA-1221R	Burgundy	Each	12/60
WA-1221RED	Red	Each	12/60
WA-1221W	White	Each	12/60



WA-1221RW

SERVICE GLOVES

6 pairs
per pack

GLC-M



WHITE COTTON SERVICE GLOVES

Elevate the dining experience with white glove service.

- ◆ 100% cotton
- ◆ 12 gloves (6 pairs) per pack

ITEM	DESCRIPTION	COLOR	UOM	CASE
GLC-M	Medium	White	Doz	100
GLC-L	Large	White	Doz	100

DISHWASHING APRONS

The easy on-and-off, full-length dishwashing aprons repel spills and splashes, keeping uniforms dry and presentable throughout a shift.

- ◆ Water resistant
- ◆ Black apron is lightweight nylon/PVC/polyester blend
- ◆ Brown apron is heavyweight vinyl with faux leather front

ITEM	DESCRIPTION	SIZE	UOM	CASE
BAW-2540BK	Black	27-1/2" W x 40"L	Each	12/60
BAW-2740BN	Brown	25-1/2" W x 40"L	Each	12/60



Brown faux leather texture

UTILITY APRONS



BAW-2740BN

BAW-2540BK



INDIVIDUALLY PACKAGED IN PRINTED POLY-BAG

HEAVY VINYL APRONS

ITEM	DESCRIPTION	SIZE	UOM	CASE
BA-HN	Heavy Vinyl w/Pocket	41-1/4"L x 26-1/2"W	Each	12/24
BA-LA	Latex	44-1/2"L x 37"W	Each	12



BA-LA

BA-HN

DISPOSABLE APRON

Quickly slip on over clothing to protect from spills and splashes.

- ◆ White plastic, waterproof bib apron
- ◆ 1 mil standard weight
- ◆ Disposable for easy, mess-free clean up
- ◆ One size fits most

ITEM	DESCRIPTION	SIZE	UOM	CASE
BADP-2846	100 Pcs/Box	28" x 46"	Box	1/12



DISPOSABLE APRON



100 pieces per dispenser box

BADP-2846



PAPER CHEF HATS

- ◆ Disposable pleated white paper
- ◆ 3 sizes with wide headband

ITEM	DESCRIPTION	SIZE	UOM	CASE
DCH-3	3" H	100 pcs/Box	Box	1/10
DCH-9	9" H	10 pcs/Bag	Bag	1/20
DCH-12	12" H	10 pcs/Bag	Bag	1/20

DISPOSABLE CHEF HATS



DCH-12

DCH-9

DCH-3

CHEF HATS



CHPB-3BR



Elastic back



CHPB-3RR



CHHW-3K

Individually packaged in printed poly-bag



Color box with full case purchase



VENTILATED PILLBOX HATS

The lightweight pillbox hat features straight sides with no brim for a clean, professional look. The ventilated mesh top is designed to help keep a cool head, and the elastic band on the back allows for a snug, secure fit.

- ◆ 65/35 poly-cotton blend
- ◆ Cool mesh top panel and elastic back
- ◆ 3-1/2" Tall; available in Regular and Extra-Large sizes
- ◆ Color display box only available with full case (FC) qty

ITEM	DESCRIPTION	SIZE	UOM	CASE
CHPB-3BR	Pillbox Hat, Black	Regular	Each	48/96
CHPB-3BX	Pillbox Hat, Black	XL	Each	48/96
CHPB-3RR	Pillbox Hat, Red	Regular	Each	48/96
CHPB-3RX	Pillbox Hat, Red	XL	Each	48/96
CHPB-3WR	Pillbox Hat, White	Regular	Each	48/96
CHPB-3WX	Pillbox Hat, White	XL	Each	48/96

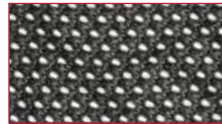

Cool mesh top



HEAD WRAP

Adjust ties at back for best fit



- ◆ 65/35 poly-cotton blend
- ◆ Lightweight, breathable comfort
- ◆ Ties at back adjust for best fit
- ◆ One size fits most

◆ Color display box only available with full case (FC) qty

ITEM	DESCRIPTION	UOM	CASE
CHHW-3K	Headwrap, Black	Each	48/96

Individually packaged in printed poly-bag



Color box with full case purchase



CHPB-3WR



BASEBALL CAP

- ◆ 65/35 poly-cotton blend
- ◆ Adjustable metal clasp for best fit
- ◆ Sturdy visor & eyelet ventilation
- ◆ Built-in sweatband helps to wick away moisture
- ◆ Color display box only available with full case (FC) qty

ITEM	DESCRIPTION	UOM	CASE
CHBC-4BK	Baseball Cap, Black	Each	36/72



CHBC-4BK

Individually packaged in printed poly-bag



Color box with full case purchase



Adjustable



CLASSIC CHEF HATS

- ◆ Wrinkle-resistant 65/35 poly-cotton
- ◆ Adjustable velcro 21" to 24"
- ◆ 13" high with wide headband

INDIVIDUALLY PACKAGED IN PRINTED POLY-BAG

ITEM	DESCRIPTION	UOM	CASE
CH-13BG	Burgundy	Each	24/96
CH-13BK	Black	Each	24/96
CH-13BL	Blue	Each	24/96
CH-13GN	Green	Each	24/96
CH-13LG	Light Green	Each	24/96
CH-13RD	Red	Each	24/96
CH-13WH	White	Each	24/96



Burgundy

Black

Blue



Green

Light Green

Red

White

CHEF JACKET SERIES'

UNIVERSAL FIT	UNF-5W	S	M	L	XL	XXL	3XL
	Neck	16	17.5	19	20.5	22	53.5
	Chest	37-39	40-42	43-45	46-49	50-53	54-57
	Sleeve	37	34.75	35.5	36.5	37.5	38.5
	Hip	39-41	42-44	45-47	48-51	52-55	56-59

MEN'S TAPERED FIT	UNF-6 / -12	S	M	L	XL	XXL	3XL	4XL
	Neck	16	16.75	17.5	18.25	19	19.75	20.5
	Chest	37-39	40-42	43-45	46-48	49-51	52-54	55-57
	Sleeve	33	34	35	36	37	38	39
	Hip	39-41	42-44	45-47	48-50	51-53	54-56	57-59

WOMEN'S TAPERED FIT	UNF-7	S	M	L
	Neck	13-14	14-15	15-16
	Chest	30.5-34	34.5-38	38.5-42
	Sleeve	31	32	33
	Hip	37.5	41	44.5

SHIRT SERIES'

SNAP-BUTTON	UNF-1	S	M	L	XL	XXL	3XL	4XL
	Neck	16	16.75	17.5	18.25	19	19.75	20.5
	Chest	36.5-39	40-42.5	43.5-46	47-49.5	50.5-53	54-56.5	57.5-60
	Sleeve	18	19.25	20.5	21.75	23	24.25	25.5

TAPERED FIT VENTILATED	UNF-9	S	M	L	XL	XXL	3XL
	Neck	16	17.25	18.5	19.75	21	22
	Chest	36.5-39	40-42.5	43.5-46	47-49.5	50.5-53	53.5-56
	Sleeve	22	23	24	25	26	27

PANT SERIES'

WOMEN'S	UNF-8K	S	M	L
	Waist	29-31	31-33	33-35
	Hip	39-40	41-42	43-44
	Inseam	31	31	32

HOUNDSTOOTH	UNF-4K	S	M	L	XL	XXL
	Waist	27-30.5	31-34.5	35-38.5	39-42.5	43-46.5
	Hip	34-37	38-41	42-45	46-49	50-53
	Inseam	30	31	32	33	34

BLACK & CHALKSTRIPE	UNF-2K / -3C / -11K	XS	S	M	L	XL	XXL
	Waist	24-28.5	29-32	32.5-35.5	36-39	39.5-42.5	43-46
	Hip	33-35.5	36-38	38.5-40.5	41-43	43.5-45.5	46-48
	Inseam	27	29	30	31	32	33

- THE SIGNATURE LOOK - MERCHANDISING DISPLAY

FREE SIGNATURE CHEF DISPLAY

available with
qualifying
order

1 display per location

Items individually
packaged in printed
clear bag

Resealable
zipper closure



Color Box is available
with each FC/full case
purchase per item.

Available with select
items as noted.



Holds 24 Cases



*The only cutlery
endorsed by
American Master
Chefs' Order*



"I use the Winco Acero knives almost daily and truly enjoy their feel, sharpness and ease of keeping them sharp. Very pleased with the product line."

- Master Chef Helmut Holzer

*Helmut F.J. Holzer CMC
Global Master Chef*

ACERO FORGED CUTLERY



The Acero cutlery collection is crafted from forged German steel. Each knife is ice tempered for ultra-sharpness and edge retention, providing professional results that won't break the bank.

Acero is the only cutlery brand endorsed by the prestigious American Master Chefs' Order, a non-profit organization comprised of an elite chef group.

- ◆ Forged, ice tempered stainless steel holds a sharp edge
- ◆ Full-tang construction for precise control
- ◆ Crafted of X50 Cr Mo V15 German steel for ultimate durability
- ◆ POM injection-molded handle for balanced weight distribution
- ◆ 6-spot advanced polishing allows for comfortable grip

ITEM	DESCRIPTION	BLADE	UOM	CASE
KFP-30	Peeling Knife	2-3/4" L	Each	6/72
KFP-35	Paring Knife	3-1/2" L	Each	6/72
KFP-50	Utility Knife	5" L	Each	6/72
KFP-51	Tomato Knife	5" L	Each	6/72
KFP-61	Boning Knife	6" L	Each	6/36
KFP-70	Santoku Knife	7" L	Each	6/36
KFP-73	Nakiri Knife	7" L	Each	6/36



The only cutlery endorsed by American Master Chefs' Order

KFP-SERIES



KFP-30

- X50 CR MO V15 German Steel
- Fully Forged - Full Tang
- Ice Tempered Blade
- Unique POM Handle



AMCO
must-have

KFP-35



KFP-50



KFP-51



KFP-61



KFP-70



KFP-73



FULLY FORGED
BLADES



ACERO FORGED CUTLERY

CHEF'S KNIVES

ITEM	DESCRIPTION	BLADE	UOM	CASE
KFP-60	Chef's Knife	6" L	Each	6/36
KFP-80	Chef's Knife	8" L	Each	6/36
KFP-84	Chef's Knife, Hollow Ground	8" L	Each	6/36
KFP-85	Chef's Knife, Short Bolster	8" L	Each	6/36
KFP-100	Chef's Knife	10" L	Each	6/36
KFP-103	Chef's Knife, Hollow Ground	10" L	Each	6/36
KFP-104	Chef's Knife Short Bolster	10" L	Each	6/36
KFP-120	Chef's Knife	12" L	Each	6/36



The only cutlery endorsed by American Master Chefs' Order

KFP-SERIES NSF



KFP-60



KFP-80



KFP-84



KFP-85



KFP-100



KFP-103



KFP-104



KFP-120

AMCO must-have

"I am a huge fan of the Acero hollow ground 8" chef's knife, and it is always a part of my travel kit for every project and dinner I do around the country."

- Master Chef Ed Janos



ACERO FORGED CUTLERY

ITEM	DESCRIPTION	BLADE	UOM	CASE
KFP-74	Fillet Knife, Flexible	7" L	Each	6/36
KFP-83	Bread Knife, Offset	8" L	Each	6/36
KFP-82	Bread Knife	8" L	Each	6/36
KFP-81	Slicer	8" L	Each	6/36
KFP-101	Slicer, Granton Edge	10" L	Each	6/36
KFP-102	Fish/Roast Slicer, Granton Edge	10" L	Each	6/36

ACERO FORGED CUTLERY



The only cutlery endorsed by American Master Chefs' Order

NSF KFP-SERIES



KFP-74



KFP-83



KFP-82



KFP-81



KFP-101



KFP-102

ACERO FORGED COOK'S FORKS

ITEM	DESCRIPTION	PRONGS	UOM	CASE
KFP-71	Straight, 12" w/Hdl	6"L	Each	6/36
KFP-62	Curved, 12" w/Hdl	6"L	Each	6/36
KFP-121	Curved, 12" w/Hdl	4"L	Each	6/36
KFP-140	Curved, 14" w/Hdl	5"L	Each	6/36
KFP-180	Curved, 18" w/Hdl	5"L	Each	6/36

NSF KFP-SERIES



KFP-71



KFP-62



KFP-121



KFP-140



KFP-180

ACERO KNIFE BLOCK SET

Stocked with essential cutlery for all food prep tasks, the knife block is space-saving and preserves the sharp edges of the knives.

ITEM	DESCRIPTION	UOM	CASE
KFP-BLKA	7-Pc Knife Block Set	Set	1/4

Set includes:

- ◆ 3.5" Paring Knife (KFP-35)
- ◆ 5" Utility Knife (KFP-50)
- ◆ 6" Boning Knife (KFP-61)
- ◆ 8" Chef Knife (KFP-80)
- ◆ 8" Bread Knife (KFP-82)
- ◆ 8" Sharpening Steel
- ◆ Wooden Knife Block
- ◆ Bonus Shears (KS-06)



ACERO FORGED CUTLERY



The only cutlery endorsed by American Master Chefs' Order



KFP-BLKA KNIVES NSF

ACERO KNIFE KIT

Must-have chef essentials for convenient storage and easy transport from kitchen to kitchen.

ITEM	DESCRIPTION	UOM	CASE
KFP-KITA	7-Pc Knife Kit	Set	1/6

Set includes:

- ◆ 3.5" Paring Knife (KFP-35)
- ◆ 6" Boning Knife (KFP-61)
- ◆ 8" Chef Knife (KFP-80)
- ◆ 8" Bread Knife (KFP-82)
- ◆ 10" Slicer (KFP-101)
- ◆ 12" Sharpening Steel (KFP-122)
- ◆ 11-slot Knife Bag (KBG-11)
- ◆ Bonus Shears (KS-06)



AMCO must-have



KFP-KITA KNIVES NSF

ACERO DIAMOND STEEL SHARPENERS

Durable and long lasting, these diamond coated steel rods sharpen knives faster than conventional stones. The extra-fine grit allows for regular honing or final polishing.

ITEM	DESCRIPTION	LENGTH	UOM	CASE
KFP-122	20mm Width, Oval	12"	Each	6/24
KFP-123	12mm Dia, Round	12"	Each	6/24



KFP-122



Shape of KFP-122



KFP-123

KFP-SHARPENERS NSF

SOF-TEK™ SOFT GRIP CUTLERY



The SOF-TEK™ series is durable and built for the demands of busy, commercial kitchens. The specially designed slip-resistant, soft-grip handle allows exceptional control, while the sharp edge provides maximum cutting performance.

- ◆ Razor-sharp X50 Cr Mo V15 German steel blade
- ◆ The comfortable soft-touch, non-slip handle helps to reduce arm and hand fatigue
- ◆ Easy edge maintenance and rapid sharpening

ITEM	DESCRIPTION	BLADE	UOM	CASE
KSTK-30	Paring Knife, 2-Pcs/Pk	3-1/4" L	Pack	6/36
KSTK-31	Serrated Paring Knife, 2-Pcs/Pk	3-1/2" L	Pack	6/36
KSTK-50	Utility Knife, Serrated Edge	5-1/2" L	Each	6/36
KSTK-60	Boning Knife, Curved	6" L	Each	6/36
KSTK-61	Boning Knife, Narrow	6" L	Each	6/36
KSTK-62	Boning Knife, Wide	6" L	Each	6/36
KSTK-82	Fillet Knife, Flexible	8" L	Each	6/36
KSTK-92	Bread/Utility Knife, Offset	9" L	Each	6/36
KSTK-91	Bread Knife, Curved, Wavy Edge	9-1/2" L	Each	6/36
KSTK-102	Bread/Pastry Knife, Wide	10" L	Each	6/36



2 pieces per pack



KSTK-30



KSTK-31



KSTK-50



KSTK-60



KSTK-61



KSTK-62



KSTK-82



KSTK-92



KSTK-91



KSTK-102

NSF

- X50 CR MO V15 German Steel
- High Carbon
- Razor sharp blade



Non-slip pinch grip for added safety



NSF KSTK-SERIES

New Item



SOF-TEK™ CHEF'S KNIVES

ITEM	DESCRIPTION	BLADE	UOM	CASE
KSTK-70	Santoku	7" L	Each	6/36
KSTK-80	Chef's Knife, Wide	8" L	Each	6/36
KSTK-100	Chef's Knife, Wide	10" L	Each	6/36

SOF-TEK™ SOFT GRIP CUTLERY



KSTK-70

KSTK-80

KSTK-100

KSTK-SERIES **NSF**

SOF-TEK™ SOFT GRIP CUTLERY

ITEM	DESCRIPTION	BLADE	UOM	CASE
KSTK-103	Cimeter, Hollow Ground	10" L	Each	6/36
KSTK-121	Slicer, Wavy Edge	12" L	Each	6/36
KSTK-122	Slicer	12" L	Each	6/36
KSTK-140	Slicer, Hollow Ground, Wide	14" L	Each	6/36



KSTK-103

KSTK-121

KSTK-122

KSTK-140

KSTK-SERIES **NSF**

STÄL STAMPED CUTLERY

 *Stäl series, our most economically priced line, offers the same level of quality and performance as others costing twice as much.*

- ◆ Razor-sharp X50 Cr Mo V15 German steel blade
- ◆ Ergonomically designed, slip-resistant white polypropylene handles offer exceptional comfort, helping to reduce arm and hand fatigue
- ◆ Protective finger guard
- ◆ Easy edge maintenance and rapid sharpening

ITEM	DESCRIPTION	BLADE	UOM	CASE
KWP-30	Paring Knife, 2-Pcs/Pk	3-1/4" L	Pack	6/36
KWP-31	Serrated Paring Knife, 2-Pcs/Pk	3-1/2" L	Pack	6/36
KWP-50	Utility Knife, Wavy Edge	5-1/2" L	Each	6/36
KWP-63	Utility Knife, Wavy Edge	6" L	Each	6/36
KWP-60	Boning Knife, Curved	6" L	Each	6/36
KWP-61	Boning Knife, Narrow	6" L	Each	6/36
KWP-62	Boning Knife, Wide	6" L	Each	6/36
KWP-92	Offset Utility/Bread Knife	9" L	Each	6/36
KWP-91	Bread Knife	9-1/2" L	Each	6/36



2 pieces per pack



KWP-30



KWP-31



KWP-50



KWP-63



KWP-60



KWP-61



KWP-62



KWP-92



KWP-91

NSF

- X50 CR MO V15 German Steel
- High Carbon
- Stain Resistant



NSF KWP-SERIES

 New Item

Winco

www.winco.us.com

STÄL CHEF'S KNIVES

ITEM	DESCRIPTION	BLADE	UOM	CASE
KWP-70	Santoku	7" L	Each	6/36
KWP-80	Chef's Knife	8" L	Each	6/36
KWP-81	Hollow Ground	8" L	Each	6/36
KWP-100	Chef's Knife	10" L	Each	6/36
KWP-101	Hollow Ground	10" L	Each	6/36

STÄL STAMPED CUTLERY



KWP-SERIES **NSF**

STÄL STAMPED CUTLERY

ITEM	DESCRIPTION	BLADE	UOM	CASE
KWP-82	Breaking Knife	8" L	Each	6/36
KWP-90	Cimeter Steak Knife	9-1/2" L	Each	6/36
KWP-93	Hollow Ground Cimeter	9-1/2" L	Each	6/36



KWP-SERIES **NSF**

STÄL STAMPED CUTLERY



STÄL BUTCHER KNIVES

ITEM	DESCRIPTION	BLADE	UOM	CASE
KWP-102	Butcher Knife	10" L	Each	6/36
KWP-124	Butcher Knife	12" L	Each	6/36



KWP-102



KWP-124

NSF KWP-SERIES

STÄL SLICERS

ITEM	DESCRIPTION	BLADE	UOM	CASE
KWP-121	Slicer, Wavy Edge	12" L	Each	6/36
KWP-122	Roast Beef Slicer	12" L	Each	6/36
KWP-123	Hollow Ground Slicer	12" L	Each	6/36



KWP-121



KWP-122



KWP-123

NSF KWP-SERIES

STÄL PARING KNIFE BULK PACK

STÄL PARING KNIFE BULK PACK

The ultra-useful paring knife now comes in bulk, packed in a convenient display bucket, perfect for impulse purchases! Available in an assortment of seven different colored handles.



- ◆ 3-1/4" paring knife made of X50 Cr Mo V15 German Steel
- ◆ Ergonomic, slip-resistant polypropylene handle is comfortable and helps to reduce hand fatigue
- ◆ Protective finger guard

ITEM	DESCRIPTION	UOM	CASE
KWP-3046	46-Pc/Pk	Pack	1/4

NSF KWP-3046

Includes 7 handle colors

STÄL KNIFE KIT

Carry and store knives in style with the convenient and travel-friendly knife roll-up storage bag. Includes 6 razor sharp, German steel stamped knives, a sharpening steel and bonus nylon spoon.

◆ Knives are NSF listed

ITEM	DESCRIPTION	UOM	CASE
KWP-KIT1	7-Pc Knife Kit	Set	1/6

Includes:

- ◆ 3.25" Paring Knife (KWP-30)
- ◆ 5.5" Utility Knife (KWP-50)
- ◆ 6" Boning Knife, Flexible (KWP-60)
- ◆ 9.5" Offset Bread/Utility Knife (KWP-91)
- ◆ 10" Hollow Ground Chef Knife (KWP-101)
- ◆ 12" Wavy Edge Slicer (KWP-121)
- ◆ 12" Sharpening Steel (K-12S)
- ◆ 11-slot Knife Bag (KBG-11)
- ◆ Bonus Red Nylon Spoon (NS-12R)



STÄL KNIFE KIT



KWP-KIT1 KNIVES **NSF**

WINCO® SPREADER BULK PACK

Practical for many uses around the kitchen, the spreader is now available in bulk. Packed in a convenient display bucket for impulse purchase positioning.

- ◆ Assortment of seven (7) colors included in convenient display bucket
- ◆ 3-5/8" spreader with stainless steel, satin finish blade
- ◆ Slip-free comfort grip

ITEM	DESCRIPTION	UOM	CASE
TWP-3135	35-Pc/Pk	Pack	1/4

WINCO® SPREADER BULK PACK



Includes 7 handle colors



TWP-3135 **NSF**



NSF KWP-COLOR SERIES

- X50 CR MO V15 German Steel
- High Carbon
- Stain Resistant



STÄL COLORED HANDLES

A selection of Stäl knives now come with HACCP color-coded non-slip handles for preventing cross-contamination and a variety of other uses around the kitchen.

- ◆ Razor-sharp X50 Cr Mo V15 German steel blade
- ◆ Ergonomically designed, slip-resistant polypropylene handles offer exceptional comfort, and help to reduce arm and hand fatigue
- ◆ Protective finger guard
- ◆ Easy edge maintenance and rapid sharpening

HACCP STANDARD COLOR-CODING SYSTEM		
Raw Meats	Raw Poultry	Vegetable & Fruit
Bakery & Dairy	Cooked Meats	Seafood

2 pieces per pack



KWP-30R



3-1/4" PARING KNIFE

ITEM	DESCRIPTION	UOM	CASE
KWP-30R	Red, 2-Pcs/Pk	Pack	6/36
KWP-30Y	Yellow, 2-Pcs/Pk	Pack	6/36
KWP-30G	Green, 2-Pcs/Pk	Pack	6/36
KWP-30N	Brown, 2-Pcs/Pk	Pack	6/36
KWP-30U	Blue, 2-Pcs/Pk	Pack	6/36



KWP-60R



6" BONING KNIFE

ITEM	DESCRIPTION	UOM	CASE
KWP-60R	Red	Each	6/36
KWP-60Y	Yellow	Each	6/36
KWP-60G	Green	Each	6/36
KWP-60N	Brown	Each	6/36
KWP-60U	Blue	Each	6/36



KWP-61R



6" NARROW BONING KNIFE

ITEM	DESCRIPTION	UOM	CASE
KWP-61R	Red	Each	6/36
KWP-61Y	Yellow	Each	6/36
KWP-61G	Green	Each	6/36
KWP-61N	Brown	Each	6/36
KWP-61U	Blue	Each	6/36

STÄL COLORED HANDLES

7" SANTOKU KNIFE

ITEM	DESCRIPTION	UOM	CASE
KWP-70R	Red	Each	6/36
KWP-70Y	Yellow	Each	6/36
KWP-70G	Green	Each	6/36
KWP-70N	Brown	Each	6/36
KWP-70U	Blue	Each	6/36



KWP-70R

8" CHEF'S KNIFE

ITEM	DESCRIPTION	UOM	CASE
KWP-80R	Red	Each	6/36
KWP-80Y	Yellow	Each	6/36
KWP-80G	Green	Each	6/36
KWP-80N	Brown	Each	6/36
KWP-80U	Blue	Each	6/36



KWP-80R

9" OFFSET BREAD KNIFE

ITEM	DESCRIPTION	UOM	CASE
KWP-92R	Red	Each	6/36
KWP-92Y	Yellow	Each	6/36
KWP-92G	Green	Each	6/36
KWP-92N	Brown	Each	6/36
KWP-92U	Blue	Each	6/36



KWP-92R

10" CHEF'S KNIFE

ITEM	DESCRIPTION	UOM	CASE
KWP-100R	Red	Each	6/36
KWP-100Y	Yellow	Each	6/36
KWP-100G	Green	Each	6/36
KWP-100N	Brown	Each	6/36
KWP-100U	Blue	Each	6/36



KWP-100R

12" WAVY EDGE SLICER KNIFE

ITEM	DESCRIPTION	UOM	CASE
KWP-121R	Red	Each	6/36
KWP-121Y	Yellow	Each	6/36
KWP-121G	Green	Each	6/36
KWP-121N	Brown	Each	6/36
KWP-121U	Blue	Each	6/36



KWP-121R

KWP-COLOR SERIES 

BLADE STATION™

HANDS-FREE KNIFE SHARPENER



BLADE STATION™ KNIFE SHARPENER

ITEM	DESCRIPTION	UOM	CASE
KSP-6	Sharpener	Set	1/6
KSP-6W	Replacement Sharpening Rods, 3-pcs/pk	Set	12/72

GET YOUR EDGE.

Blade Station™
keeps the
line moving



TIME SAVING

Has knives as
sharp as NEW
in just **4 swipes**



SAFE & SECURE

Hands-Free!
Reduce liability by
keeping employees
safe from cuts



MOVABLE

Easily
transport to
any worktop



EASY TO CLEAN

Dishwasher safe



DIAMOND COATED

Rod sharpens
both sides
together



ADAPTABLE MOUNTING

Base can be
screwed down
or clamped on



"The Blade Station knife sharpener is
the only thing at Chicago NRA show
I had to have."

Chef Brad Emel

Seabrook Classic Cafe, Seabrook, TX



ACERO FOUR-STAGE KNIFE SHARPENER

When you need to sharpen standard or Asian style knives, look no further than this one tool for the job. Designed for the commercial kitchen, the wide, rubberized base provides stability for any busy chef to sharpen their favorite knife.

- ◆ For either standard or Asian style knives; coarse stages quickly sharpen dull knives, while fine stages hone to a razor sharp edge
- ◆ Reduced wobbling - the safest sharpener with oversized non-slip base
- ◆ Most ergonomic handle available for comfort, slip-resistance and excellent grip control

ITEM	DESCRIPTION	UOM	CASE
KSP-4	9-7/8"L x 2-5/8"W x 3-3/4"H	Each	12/24



ACERO FOUR-STAGE KNIFE SHARPENER



The only cutlery endorsed by American Master Chefs' Order



KSP-4 

DUAL-STAGE KNIFE SHARPENER

- ◆ Soft-grip ergonomic handle with non-skid base
- ◆ Coarse carbide steel blades for sharpening and ceramic rods for honing

ITEM	DESCRIPTION	UOM	CASE
KSP-2	7-5/8"L x 2-1/2"W x 2"H	Each	12/48

DUAL-STAGE KNIFE SHARPENER



KSP-2

SHARPENING STEELS



NSF KFP-122 (OVAL)



NSF KFP-123 (ROUND)



NSF K-34S (ROUND)



NSF K-54S (OVAL)



NSF K-12S



NSF K-14S

SHARPENING STONES & GUIDE

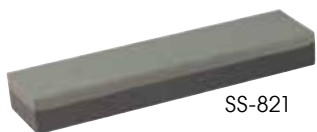

SS-821



SS-1211



K-4G



K-4G holds blade at ideal sharpening angle

ACERO DIAMOND STEEL SHARPENERS

Durable and long lasting, these diamond coated steel rods maintain sharp knife blades. The extra-fine grit allows for regular honing or final polishing.

ITEM	DESCRIPTION	LENGTH	UOM	CASE
KFP-122	20mm Width, Oval	12"	Each	6/24
KFP-123	12mm Dia, Round	12"	Each	6/24



KFP-122

Oval Rod provides wider surface area

PREMIUM SHARPENING STEELS

Made of super hard HRC59-63 steel, the magnetic rod attracts metal shavings while honing to prevent debris from sticking to knives and getting onto food.

ITEM	DESCRIPTION	LENGTH	UOM	CASE
K-34S	13mm Dia, Round	14"	Each	6/24
K-54S	22mm Width, Oval	14"	Each	6/24



Standard Round Rod



Oval Rod provides wider surface area

SHARPENING STEELS

◆ Round rod maintains a sharp knife blade

ITEM	DESCRIPTION	LENGTH	UOM	CASE
K-12S	Stainless Steel	12"	Each	12/24
K-14S	Stainless Steel	14"	Each	12/24

COMBINATION SHARPENING STONE

- ◆ High-grade carbonized silicon for quick, long-lasting sharp edges
- ◆ Dual-sided fine and medium grain for blade sharpening and reshaping
- ◆ For best results, soak stone for 30-45 minutes until fully saturated, place wet stone on towel to sharpen knives. Keep stone moistened throughout sharpening process.

ITEM	DESCRIPTION	UOM	CASE
SS-821	8"L x 2"W x 1"H	Each	24
SS-1211	12"L x 2-1/2"W x 1-1/2"H	Each	12

SHARPENING GUIDE WITH CERAMIC INSERTS

Sharpening knives has never been easier! Sharpening guides by Winco keep knives at the optimal angle while using sharpening stones.

- ◆ Ideal sharpening angle for ultimate knife performance
- ◆ Durable plastic body with protective ceramic inserts
- ◆ For use with 6" and larger chef's knives

ITEM	DESCRIPTION	UOM	CASE
K-4G	Sharpening Guide	Each	12/144

SOF-TEK™ ALL-PURPOSE UTILITY KNIFE

Outfitted with a soft-grip handle, a thumb groove for precision handling, and a partial serrated edge to easily pierce skins and peels.

- ◆ Angled soft-touch, non-slip handle keeps knuckles off cutting surface
- ◆ Thumb groove for added leverage
- ◆ Serrated edge ideal for piercing tough peels

ITEM	DESCRIPTION	UOM	CASE
KPR-30	3-1/2"L Blade	Doz	1/4



Thumb groove



Pierce tough peels



Serrated edge

UTILITY KNIVES

Labeled for individual sale



PP WHITE HANDLE PARING KNIFE

ITEM	DESCRIPTION	UOM	CASE
K-40P	3"L Blade	Each	12/360



K-40P NSF

HOBBY KNIFE

ITEM	DESCRIPTION	UOM	CASE
KH-6	5-3/4"L, with 5 Bonus Blades	Each	12/144
KH-5R	Replacement Blades for KH-6, 5pcs/pk	Each	100/1000



KH-6

STAINLESS STEEL MESH GLOVES

Rust resistant 304L stainless steel made for meat processing. Reversible/ambidextrous with snap-and-cinch wrist strap.

- ◆ Light-weight and non-corrosive
- ◆ Reversible for either left or right hand

ITEM	DESCRIPTION	UOM	CASE
PMG-1S	Small, White Strap	Each	10/50
PMG-1M	Medium, Red Strap	Each	10/50
PMG-1L	Large, Blue Strap	Each	50

PROTECTIVE GLOVES



Closure Detail



Mesh Detail



PMG-1L

ANTI-MICROBIAL CUT-RESISTANT GLOVES

Strong and flexible high-density fibers reduces cuts from sharp edges or a slip of the knife.

- ◆ Anti-microbial yarn reduces bacterial growth
- ◆ Color-coded wristband for quick size identification
- ◆ Reversible for either left or right hand
- ◆ FDA approved materials for direct food contact

ITEM	DESCRIPTION	WRISTBAND	UOM	CASE
GCRA-S	Small	Red	Each	12/120
GCRA-M	Medium	Green	Each	12/120
GCRA-L	Large	Gray	Each	12/120
GCRA-XL	Extra Large	Black	Each	12/120



GCRA-L



GCRA-M

CAUTION: cut-resistant gloves are not cut-proof or puncture resistant. Do not use with/near serrated or moving blades.

KITCHEN SHEARS



The only cutlery endorsed by American Master Chefs' Order



KS-06

ACERO ALL-PURPOSE DETACHABLE KITCHEN SHEARS

ITEM	DESCRIPTION	UOM	CASE
KS-06	All-Purpose Kitchen Shears, Detachable	Each	12/72



KS-06 is detachable



Built-in cracker or bottle cap grip



Built-in bottle cap opener



ALL-PURPOSE KITCHEN SHEARS

ITEM	DESCRIPTION	UOM	CASE
KS-01	All-Purpose Kitchen Shears	Each	12/120



KS-01



Built-in bottle cap opener



Built-in cracker or bottle cap grip



POULTRY SHEARS

ITEM	DESCRIPTION	UOM	CASE
KS-02	Soft-Grip PP Hdl	Each	12/72
KS-03	Stainless Steel	Each	10/50



KS-02



Locks closed



KS-03



Locks closed



MULTI-BLADE HERB SHEARS

- ◆ 5 stainless steel blades
- ◆ Trim, dice, and mince a variety of herbs
- ◆ PP and TPR handle for safe and comfortable grip

ITEM	DESCRIPTION	UOM	CASE
KS-05	5-Layer Blade	Each	12/72



KS-05



PROFESSIONAL CLEAVERS

ACERO EXTRA HEAVY-DUTY CLEAVER

- ◆ Heavy-duty full tang, true forged, ice tempered blade
- ◆ Triple riveted comfort-grip POM handle
- ◆ High carbon stainless steel for long-lasting durability
- ◆ Hole for gripping top of blade to assist pull-through on tough or frozen meat; also for hanging storage

ITEM	DESCRIPTION	UOM	CASE
KFP-72	7"L x 4-3/8"W Blade	Each	6/24



The only cutlery endorsed by American Master Chefs' Order



KFP-72 NSF

HEAVY-DUTY CLEAVER

- ◆ High carbon stainless steel for long-lasting durability
- ◆ Heavy-duty blade for cleaving meat, joints, and tendons
- ◆ Triple-riveted full-tang wooden handle
- ◆ Hole for gripping top of blade to assist pull-through on tough or frozen meat; also for hanging storage

ITEM	DESCRIPTION	UOM	CASE
KC-301	8"L x 3-1/2"W Blade	Each	6/24



KC-301

STEEL HANDLE CHINESE CLEAVERS

- ◆ One-piece high carbon stainless steel for long-lasting durability and easy cleaning
- ◆ Sturdy and agile cutting, trimming, mincing and more
- ◆ Wide blade ideal for transferring choppings from prep area to cooking vessel
- ◆ Comfortable round handle with finger notches, and blunt end doubles as a pestle

ITEM	DESCRIPTION	UOM	CASE
KC-401	8-1/4"L x 4"W Blade	Each	12/36
KC-501	8"L x 2-1/4"W Blade	Each	10/50



KC-401 NSF



KC-501 NSF

POM HANDLE CHINESE CLEAVERS

- ◆ High carbon stainless steel for long-lasting durability
- ◆ Sturdy and agile cutting, trimming, mincing and more
- ◆ Wide blade ideal for transferring choppings from prep area to cooking vessel
- ◆ Round, enduring POM handle with blunt end that doubles as a pestle

ITEM	DESCRIPTION	UOM	CASE
KC-601	8"L x 3-1/2"W Blade	Each	6/36



KC-601 NSF

WOODEN HANDLE CHINESE CLEAVERS

- ◆ High carbon stainless steel for long-lasting durability
- ◆ Sturdy and agile cutting, trimming, mincing and more
- ◆ Wide blade ideal for transferring choppings from prep area to cooking vessel
- ◆ Classic round wooden handle with blunt end that doubles as a pestle

ITEM	DESCRIPTION	UOM	CASE
KC-101	8"L x 3-1/2"W Blade	Each	12/24
KC-201R	7"L x 2"W Blade	Each	12/48



KC-101



KC-201R



KNIFE BLADE GUARDS



The only cutlery endorsed by American Master Chefs' Order



KGD-41



KGD-815



KGD-102



KNIFE BLADE GUARDS

Safely store and transport knives.

- ◆ Ideal for stamped or forged blades
- ◆ Felt interior prevents dulling

ITEM	DESCRIPTION	SIZE	UOM	CASE
KGD-41	Fits 2-1/2" to 3-1/2" blade, 2-Pcs/Pk	4" x 1"	Pack	12/72
KGD-61	Fits 5" to 6" blade, 2-Pcs/Pk	6" x 1"	Pack	12/72
KGD-62	Fits 6" blade	6" x 2"	Each	12/72
KGD-815	Fits 7" to 8" blade	8" x 1-1/2"	Each	12/72
KGD-82	Fits 7" to 8" blade	8" x 2"	Each	12/72
KGD-1015	Fits 10" blade	10" x 1-1/2"	Each	12/72
KGD-102	Fits 9" to 10" blade	10" x 2"	Each	12/72
KGD-122	Fits 11" to 12" blade	12" x 2"	Each	12/72

Can be used with bolsters and angled-handle knives



KGD-41 with KWP-30 knife



KGD-815 with KFP-80 knife

KNIFE STORAGE



MAGNETIC KNIFE BARS

- ◆ Securely hold knives out of the way and at the ready



WMB-18



PMB-18

ITEM	DESCRIPTION	UOM	CASE
WMB-12	12", Wooden Base	Each	1/36
WMB-18	18", Wooden Base	Each	1/24
WMB-24	24", Wooden Base	Each	1/24
PMB-13	13", Plastic Base	Each	1/36
PMB-18	18", Plastic Base	Each	1/36
PMB-24	24", Plastic Base	Each	1/24

STAINLESS STEEL 7-SLOT KNIFE RACK

- ◆ Mounts to wall for safe accessibility



KR-9

ITEM	DESCRIPTION	UOM	CASE
KR-9	S/S Knife Rack, 7 Slots	Each	1/12

KNIFE BACKPACK & INNER CASE

The Winco multi-functional and secure backpack is ideal for the chef-on-the-go. As a stand-alone, it has an array of useful features. Used with the knife case, this combo easily solves every chef's dilemma of how to safely and securely transport knives.

- ◆ Backpack features wide, ergonomic straps with a back airflow system for extra comfort
- ◆ Padded laptop sleeve compartment with locking zippers
- ◆ Perfectly accommodates Winco's KBP-2 hard case
- ◆ The KBP-2 hard case has 10 slots to fit a variety of knives; has removable strap, which can be used for carrying without backpack

ITEM	DESCRIPTION	UOM	CASE
KBP-1	Backpack	Each	12
KBP-2	Inner Case	Each	12
KBP-S	Backpack w/Inner Knife Case	Set	4

KNIFE BACKPACK & INNER CASE



KBP-S
Backpack and Inner Case set



HARD CASE
KBP-2



- Easy-access lined top pocket fits glasses or cell phone
- Wide, ergonomic shoulder straps with zippered stash pocket
- Lockable zippers on compartment that fits a standard laptop
- Securely lock zippers on large main compartment
- Audio interface and zipper pocket on front
- Airflow back system for extra comfort
- Internal zipper pockets for wallet or valuables
- Wide mesh pocket on each side, great for water bottle

KBP-1

KNIFE BAGS

ITEM	DESCRIPTION	UOM	CASE
KBG-8	8 Slot Knife Roll	Each	24
KBG-11	11 Slot Knife Bag	Each	12
KBG-29	29 Slot Triple-Zip Knife Bag	Each	12

KNIFE BAGS



KBG-29



KBG-11



KBG-8



PIZZA CUTTERS



KSTK-40

SOFT-TEK™ PIZZA CUTTER

The specially designed soft-touch, non-slip handle of the Sof-Tek series is also available as a pizza cutter.

- ◆ Razor sharp 4" diameter blade
- ◆ Protective finger guard

ITEM	DESCRIPTION	BLADE	UOM	CASE
KSTK-40	Sof-Tek Handle	4" Dia	Each	6/36



PWC-4



PPC-4



VP-316



PPC-4W

PIZZA CUTTERS

ITEM	DESCRIPTION	BLADE	UOM	CASE
PWC-4	Wooden Handle	4" Dia	Each	12/72
PPC-2	Black PP Handle	2-1/2" Dia	Each	12/72
PPC-4	Black PP Handle	4" Dia	Each	12/72
PPC-2W	White Handle	2-1/2" Dia	Each	12/72
PPC-4W	White Handle	4" Dia	Each	12/72
VP-315	Soft Grip Handle	2-1/2" Dia	Each	12/72
VP-316	Soft Grip Handle	4" Dia	Each	12/72

PIZZA KNIVES

18" AND 20" PIZZA KNIVES

ITEM	DESCRIPTION	UOM	CASE
KPP-18	18" Pizza Knife	Each	6/24
KPP-20	20" Pizza Rocker Knife	Each	6/24



NSF KPP-18



NSF KPP-20

Refer to Pizza Supplies for full range of pizza prep and serveware

CHOPPING KNIVES

18/8 STAINLESS STEEL MEZZALUNA CHOPPING KNIVES

- ◆ Rock the crescent-shaped blade side-to-side to effortlessly chop tender herbs and greens
- ◆ Use an up-and-down motion to chop larger, more dense vegetables
- ◆ Ergonomic design allows you to chop effortlessly



KCC-3



KCC-4

ITEM	DESCRIPTION	UOM	CASE
KCC-3	Single Blade	Each	12/72
KCC-4	Double Blade	Each	12/72



NSF KCC-1



NSF KCC-2

CHOPPING KNIVES

- ◆ Use flat blade on cutting boards to chop and mince food
- ◆ Use rounded edges inside mixing bowls to cut and fold ingredients
- ◆ Dishwasher safe

ITEM	DESCRIPTION	UOM	CASE
KCC-1	Single Blade	Each	6/72
KCC-2	Double Blade	Each	6/48

OYSTER/CLAM KNIVES

ITEM	DESCRIPTION	SIZE (O.L.)	UOM	CASE
VP-314	2-7/8" Blade, Soft Rubber Grip NSF	7-5/8"	Each	12/72
KCL-5P	3" Blade, Plastic Handle, NSF	6-3/4"	Each	12/72
KCL-1	2-3/4" Blade, Wooden Handle	5-7/8"	Each	12/72
KCL-2	2-7/8" Blade, Wooden Handle	6-5/8"	Each	12/72
KCL-3	3-1/2" Blade, Wooden Handle	7-1/2"	Each	12/72



OYSTER/CLAM KNIVES



DOUBLE HANDLE CHEESE KNIFE

ITEM	DESCRIPTION	UOM	CASE
KCP-15	15"L, Double PP Handles	Each	6/24

DUAL HANDLE CHEESE KNIFE



KCP-15 NSF

CHEESE KNIFE SETS

Slice and serve a full range of cheeses.

- ◆ Each set includes 6 knives for hard, soft, firm, or crumbly types of cheeses
- ◆ Stainless steel blades

ITEM	DESCRIPTION	UOM	CASE
KCS-6	6-Pc Set w/POM Hdls	Set	1/24
KCS-6W	6-Pc Set w/Wooden Hdls	Set	6/48

Shown with wooden cutting board #WCB-125



CHEESE KNIFE SETS



STEAK KNIVES



The only cutlery endorsed by American Master Chefs' Order

ACERO STEAK KNIVES

A Winco® exclusive, these heavyweight knives are a must-have on the tables of any steakhouse. Stainless steel end cap provides excellent balance and control.

- ◆ Full-tang construction for precision and control
- ◆ Crafted of X50 Cr Mo V15 German steel for the ultimate in durability
- ◆ POM injection-molded handle for balanced weight distribution
- ◆ 6-spot advanced polishing allows for a comfortable grip

ITEM	DESCRIPTION	BLADE	UOM	CASE
SK-22	Acero Gourmet Steak Knives, Round Tip	5"	Doz	1/6
SK-12	Acero Gourmet Steak Knives, 12-pc Bulk Pack	5"	Doz	1/6
SK-1	Acero Gourmet Steak Knives, 4-pc Gift Pack	5"	Pack	1/6



NSF SK-22



NSF SK-12

10"



NSF SK-1

4 Piece Boxed Set

JUMBO PLASTIC HANDLE STEAK KNIVES



NSF K-81P



ITEM	DESCRIPTION	BLADE	UOM	CASE
K-81P	Jumbo Steak Knives, 6-Pcs/Pk	4-3/4"	Pack	6/12
K-85P	Round Tip, Plastic Hdl	5"	Doz	1/12



NSF K-85P



K-81P
6-piece Jumbo steak knives

SOLID POM HANDLE STEAK KNIVES



K-70P



K-71P



K-80P

ITEM	DESCRIPTION	BLADE	UOM	CASE
K-70P	Pointed Tip, POM Hdl	5"	Doz	1/24
K-71P	Round Tip, POM Hdl	4-1/2"	Doz	1/24
K-80P	Round Tip, POM Hdl	5"	Doz	1/25

PLASTIC HANDLE STEAK KNIVES



NSF K-60P



NSF K-50P

ITEM	DESCRIPTION	BLADE	UOM	CASE
K-60P	Pointed Tip	5"	Doz	1/24
K-50P	Round Tip	5"	Doz	1/48

EURO-SLIM STEAK KNIFE

Offering superior durability and attractive form, ideal for use in commercial venues

- ◆ 12 pieces packaged in hanging clear-view pack

ITEM	DESCRIPTION	BLADE	UOM	CASE
K-73PC	Pointed Tip, ABS Handle, 3 Rivets	4-1/2"	Doz	1/24



Serrated blade



Metal plaque detail



12-piece Euro-slim knives



9-1/4"

K-73PC

- ◆ Stainless steel blade for long-lasting durability
- ◆ Durable wood handle

JUMBO WOODEN HANDLE STEAK KNIVES

ITEM	DESCRIPTION	BLADE	UOM	CASE
K-82	Pointed Tip, Polywood Handle, 3 Rivets	4-3/4"	Pack	6/12
KB-15W	Round Tip, Oak Wood Handle	5"	Doz	1/12
KB-30W	Pointed Tip, Oak Wood Handle	5"	Doz	1/12



K-82

6-piece Polywood handle steak knives

WOODEN HANDLE STEAK KNIVES



K-82



KB-15W



KB-30W

WOODEN HANDLE STEAK KNIVES

ITEM	DESCRIPTION	BLADE	UOM	CASE
K-55W	Rounded Tip	4-1/2"	Doz	1/48
K-45W	Pointed Tip	4-1/2"	Doz	1/48
K-438W	Pointed Tip and Handle	4-3/8"	Doz	1/24
K-35W	Economy, Pointed Tip	4"	Doz	1/48



K-55W



K-45W



K-438W



K-35W

- WINCO PRODUCTS - MERCHANDISING DISPLAY PROGRAM

FREE DISPLAY available with qualifying order

1 display per location

1

Select your program from
5 pre-set options.



DR-BNOS (ONE SOURCE)



DR-BNCA (ACERO)



DR-BNKU (UTENSILS)



DR-BNTH (THERMOMETERS)



DR-BNWP (WINCO PRIME)

2

Pick 18 items (@ qty break) from
the list for selected program.

3

Receive:

(1) 2-sided slatwall display,
(1) sign, (18) 6" hooks, (4) casters

See your sales rep
for program details



Master Chefs' Order Approved



INDUCTION-READY

TRI=GEN™

by **winco**

NEXT
GENERATION
COOKWARE



TRI=GEN™
COOKWARE



- Fry Pans
- Sauté Pans
- Sauce Pans
- Stock Pots
- Braziers





EXCALIBUR®
Non-stick finish

Excalibur non-stick finish is reinforced externally with a proprietary stainless-steel alloy

Highest performing commercial coating available



TRI-PLY INDUCTION-READY FRY PANS

- ◆ Handles offer excellent comfort and pan control, minimizing hand fatigue for high-volume operators
- ◆ Triangular positioned rivets provide strength - will not loosen in high-volume commercial kitchens
- ◆ Available in natural and Excalibur® non-stick finishes
- ◆ 5 sizes available

ITEM	DESCRIPTION	SIZE	UOM	CASE
TGFP-7	Natural Finish	7"	Each	1/6
TGFP-7NS	Non-stick	7"	Each	1/6
TGFP-8	Natural Finish	8"	Each	1/6
TGFP-8NS	Non-stick	8"	Each	1/6
TGFP-10	Natural Finish	10"	Each	1/6
TGFP-10NS	Non-stick	10"	Each	1/6
TGFP-12	Natural Finish	12"	Each	1/2
TGFP-12NS	Non-stick	12"	Each	1/2
TGFP-14	Natural Finish	14"	Each	1/2
TGFP-14NS	Non-stick	14"	Each	1/2

7"



8"



12"



10"



14"



TGFP-SERIES



NON-STICK FRY PANS

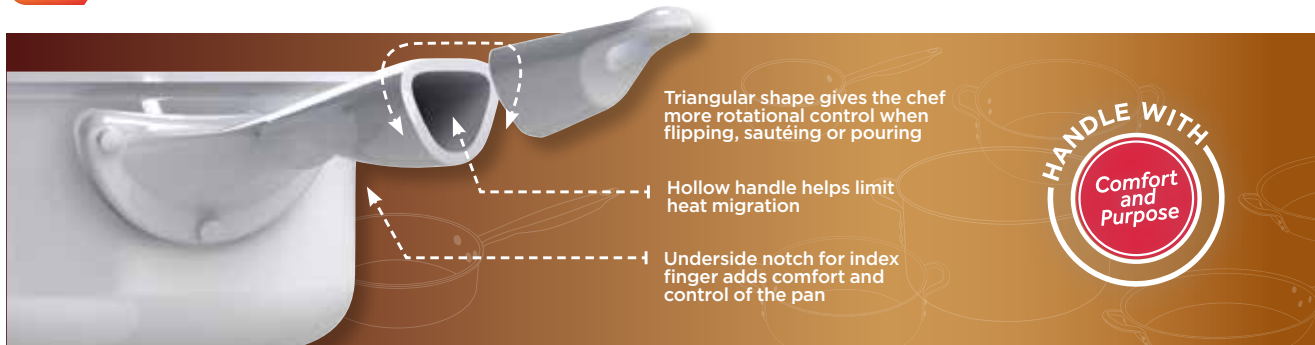

TRI-PLY INDUCTION-READY SAUCE PANS

- ◆ Perfect for preparing many dishes with style and comfort
- ◆ Triangular positioned rivets provide strength - will not loosen in high-volume commercial kitchens
- ◆ Mirror finish exterior; satin finish interior
- ◆ 5 sizes available

ITEM	DESCRIPTION	SIZE	DIA	UOM	CASE
TGAP-2	Sauce Pan w/ Cover	1.5 Qt	6"	Set	1/6
TGAP-3	Sauce Pan w/ Cover	2.5 Qt	7"	Set	1/6
TGAP-4	Sauce Pan w/ Cover	3.5 Qt	8"	Set	1/4
TGAP-5	Sauce Pan w/ Cover	4.5 Qt	8.5"	Set	1/4
TGAP-7	Sauce Pan w/ Cover, Helper Hdl	7 Qt	9.5"	Set	1/2

Handles built for comfort and purpose.



TGAP-5
17-3/8"L x 9-1/4"W including handle
5-1/8"H pan only



TGAP-2
14-1/2"L x 7"W including handle
3-5/8"H pan only



TGAP-3
15-1/8" x 7-3/4" including handle
4-1/8" pan only



TGAP-7
19-7/8"L x 10"W including handles
6-1/2"H pan only



TGAP-4
16-5/8" x 8-1/2" including handle
4-3/4" pan only

TGAP-SERIES  

Visually
stunning

Highly
functional

TRI-PLY INDUCTION-READY SAUTÉ PANS

- ◆ Deep, straight sides for easy stirring, mixing or flipping food without spilling
- ◆ Sauté, brown or stir-fry with ease
- ◆ Mirror finish exterior; satin finish interior
- ◆ 4 sizes available

ITEM	DESCRIPTION	SIZE	DIA	UOM	CASE
TGET-2	Sauté Pan w/ Cover	2 Qt	8"	Set	1/6
TGET-3	Sauté Pan w/ Cover	3 Qt	9.5"	Set	1/6
TGET-6	Sauté Pan w/ Cover, Helper Hdl	6 Qt	12.5"	Set	1/4
TGET-7	Sauté Pan w/ Cover, Helper Hdl	7 Qt	14"	Set	1/2

2qt



TGET-2

16-5/8"L x 8-1/2"W
including handle
3-1/4"H pan only

6qt



TGET-6

24-1/4"L x 13-1/8"W
including handles
4-1/8"H pan only

3qt



TGET-3

18-1/8"L x 10"W
including handle
3-5/8"H pan only

7qt



TGET-7

26-1/8"L x 15"W
including handles
4"H pan only



TGET-SERIES



Triangular shaped handle with outward sloping top provides the chef with better control and a more comfortable thumb rest.

Compatible with
Induction, Gas & Electric



TRI-PLY INDUCTION-READY STOCK POTS

- ◆ Larger sizes for higher volume food preparation
- ◆ Securely riveted wide loop handles provide excellent stability, and roomy for handling with hot pads
- ◆ Mirror finish exterior; satin finish interior
- ◆ 6 sizes available



Strength & Balance

ITEM	DESCRIPTION	SIZE	DIA	UOM	CASE
TGSP-4	Stock Pot w/Cover	4.5 Qt	8.5"	Set	1/6
TGSP-6	Stock Pot w/Cover	6 Qt	8.5"	Set	1/6
TGSP-8	Stock Pot w/Cover	8 Qt	9.5"	Set	1/6
TGSP-12	Stock Pot w/Cover	12 Qt	12"	Set	1/4
TGSP-16	Stock Pot w/Cover	16 Qt	12.5"	Set	1/4
TGSP-20	Stock Pot w/Cover	20 Qt	14"	Set	1/4

12qt



TGSP-12
16-1/2"W including handles
7-1/4"H pot only

4.5qt



TGSP-4
13"W including handles
5-1/4"H pot only

16qt



TGSP-16
17-1/4"W including handles
8-1/4"H pot only

6qt



TGSP-6
13"W including handles
6-5/8"H pot only

20qt





TGSP-20
19"W including handles
8-1/4"H pot only

8qt



TGSP-8
13-3/4"W including handles
7-3/8"H pot only

TGSP-SERIES  

-  Induction
-  Gas
-  Electric

 **TRI-PLY INDUCTION-READY BRAZIER**

- ◆ Larger sizes for higher volume food preparation
- ◆ Securely riveted wide loop handles provide excellent stability, and roomy for handling with hot pads
- ◆ Mirror finish exterior; satin finish interior
- ◆ 2 sizes available

ITEM	DESCRIPTION	SIZE	DIA	UOM	CASE
TGBZ-12	Brazier w/Cover	12 Qt	13.5"	Set	1/4
TGBZ-14	Brazier w/Cover	14 Qt	14"	Set	1/4

12qt



TGBZ-12

18"W including handles
5-1/2"H brazier only

14qt



TGBZ-14

19"W including handles
6"H brazier only



TGBZ-SERIES

Packaging





PREMIUM 18/8 STAINLESS STEEL COOKWARE

- ◆ Commercial-quality 18/8 stainless steel offers excellent corrosion resistance and a bright finish
- ◆ Tri-ply heavy-duty bottom for even heat distribution
- ◆ Extra-sturdy riveted handles
- ◆ Induction ready



Riveted handles



PREMIUM STAINLESS STEEL COOKWARE



STOCK POTS WITH COVER INCLUDED

ITEM	DESCRIPTION	SIZE (DIA X HEIGHT)	UOM	CASE
SST-8	8 Qt	9-1/2" x 6-3/4"	Set	1/4
SST-12	12 Qt	11" x 7-1/8"	Set	1/4
SST-16	16 Qt	11" x 9-3/4"	Set	1/4
SST-20	20 Qt	11-3/4" x 10-1/4"	Set	1/4
SST-24	24 Qt	13-3/8" x 10-1/4"	Set	1/2
SST-32	32 Qt	14-1/4" x 11-3/4"	Set	1/2
SST-40	40 Qt	15-3/4" x 11-3/4"	Set	1/2
SST-60	60 Qt	17-3/4" x 14-1/4"	Set	1
SST-80	80 Qt	19-3/4" x 15-3/4"	Set	1

REPLACEMENT COVERS

ITEM	UOM	CASE
SSTC-8	Each	6/12
SSTC-12	Each	6/12
SSTC-12	Each	6/12
SSTC-20	Each	6/12
SSTC-24	Each	6
SSTC-32	Each	6
SSTC-40	Each	6
SSTC-60	Each	6
SSTC-80	Each	6

SAUCE PANS WITH COVER INCLUDED

ITEM	DESCRIPTION	SIZE (DIA X HEIGHT)	UOM	CASE
SSSP-2	2 Qt	6-3/8" x 3-3/4"	Set	1/6
SSSP-3	3 -1/2 Qt	8" x 4-1/4"	Set	1/6
SSSP-4	4 -1/2 Qt	8" x 5-1/2"	Set	1/6
SSSP-6	6 Qt	9-1/2" x 5"	Set	1/6
SSSP-7	7 -1/2 Qt w/Hdl	9-1/2" x 6-1/8"	Set	1/2
SSSP-10	10 Qt w/Hdl	11" x 6-1/8"	Set	1/2

REPLACEMENT COVERS

ITEM	UOM	CASE
SSTC-2	Each	6
SSTC-8F	Each	6/12
SSTC-8F	Each	6/12
SSTC-8	Each	6/12
SSTC-8	Each	6/12
SSTC-12	Each	6/12

BRAZERS WITH COVER INCLUDED

ITEM	DESCRIPTION	SIZE (DIA X HEIGHT)	UOM	CASE
SSLB-8	8 Qt	11" x 5-1/8"	Set	1/4
SSLB-10	10 Qt	11-11/16" x 5-1/2"	Set	1/4
SSLB-15	15 Qt	14-1/4" x 5-1/2"	Set	1/4
SSLB-20	20 Qt	15-3/4" x 6"	Set	1/4
SSLB-25	25 Qt	17-3/4" x 6"	Set	1/2
SSLB-30	30 Qt	19-3/4" x 6"	Set	1/2

REPLACEMENT COVERS

ITEM	UOM	CASE
SSTC-12	Each	6/12
SSTC-20	Each	6/12
SSTC-32	Each	6
SSTC-40	Each	6
SSTC-60	Each	6
SSTC-80	Each	6

SAUTÉ PANS WITH COVER INCLUDED

ITEM	DESCRIPTION	SIZE (DIA X HEIGHT)	UOM	CASE
SSET-3	3 Qt	10" x 2-3/4"	Set	1/6
SSET-5	5 Qt	12-3/8" x 3-1/8"	Set	1/4
SSET-7	7 Qt	14" x 3-1/2"	Set	1/4

REPLACEMENT COVERS

ITEM	UOM	CASE
SSTC-8	Each	6/12
SSTC-20	Each	6/12
SSTC-24	Each	6



PREMIUM STAINLESS STEEL OMELET PANS



SSOP-12



SSOP-SERIES



STAINLESS STEEL OMELET PANS

- ◆ Tri-ply base for even heat distribution
- ◆ Induction compatible
- ◆ Riveted, sturdy handles

ITEM	DESCRIPTION	SIZE (DIA X H)	UOM	CASE
SSOP-12	12-1/2"	12-1/2" x 2-1/4"	Each	1/2



PREMIUM STAINLESS STEEL FRY PANS



SSFP-11



SSFP-14



SSFP-SERIES

- ◆ Heavy-duty premium 18/8 stainless steel offers excellent corrosion resistance and a bright finish
- ◆ Tri-ply bottom for even heat distribution
- ◆ Extra-sturdy riveted handles



STAINLESS STEEL FRY PANS

- ◆ Natural finish
- ◆ Ideal for searing meat, achieving a flavorful crust, sautéing vegetables, and more

ITEM	DESCRIPTION	SIZE	UOM	CASE
SSFP-8	8"	8" x 1-1/2"	Each	1/6
SSFP-9	9-1/2"	9-1/2" x 1-3/4"	Each	1/6
SSFP-11	11"	11" x 2"	Each	1/6
SSFP-12	12", Help Hdl	12-1/2" x 2"	Each	1/2
SSFP-14	14", Help Hdl	14-1/4" x 2-1/2"	Each	1/2



SSFP-11NS



SSFP-14NS



SSFP-SERIES



NON-STICK FRY PANS



NON-STICK FRY PANS

- ◆ Excalibur® non-stick coating
- ◆ Ideal for delicate foods like fried egg, flaky fish, etc.

ITEM	DESCRIPTION	SIZE	UOM	CASE
SSFP-8NS	8"	8" x 1-1/2"	Each	1/6
SSFP-9NS	9-1/2"	9-1/2" x 1-3/4"	Each	1/6
SSFP-11NS	11"	11" x 2"	Each	1/6
SSFP-12NS	12", Help Hdl	12-1/2" x 2"	Each	1/2
SSFP-14NS	14", Help Hdl	14-1/4" x 2-1/2"	Each	2

COVERS FOR STAINLESS STEEL FRY PANS

ITEM	DESCRIPTION	UOM	CASE
SSTC-8F	Cover for 8" Fry Pans	Each	6/12
SSTC-8	Cover for 9-1/2" Fry Pans	Each	6/12
SSTC-12	Cover for 10" and 11" Fry Pans	Each	6/12
SSTC-12F	Cover for 12" Fry Pans	Each	6/12
SSTC-32	Cover for 14" Fry Pans	Each	6

PREMIUM STAINLESS STEEL 7-PIECE COOKWARE SET

- ◆ Extra heavy-weight 18/8 stainless steel with double riveted handles
- ◆ Aluminum core, best for fast and even distribution of heat, is impact-bonded between two layers of stainless steel for long-lasting use

ITEM	DESCRIPTION	UOM	CASE
SPC-7H	7-Pc Set	Set	1/2



SPC-7H  

PREMIUM STAINLESS STEEL 7PC COOKWARE SET

Set Includes:

- ◆ 1 Qt Sauce Pan w/Cover
- ◆ 2 Qt Sauce Pan w/Cover
- ◆ 5 Qt Dutch Oven w/Cover
- ◆ 9-1/2" Sauté Pan

EGG POACHER SET: ALUMINIZED STEEL PAN WITH INNER NON-STICK CUPS

When a meal calls for perfectly poached eggs, this 4-cup set gets the job done quickly. The glass lid provides easy monitoring without the loss of heat so eggs cook uniformly. Also functions as mini double-boiler to melt butter or chocolate, or steam individual custard portions.

- ◆ Suitable for all stove tops, including induction
- ◆ Handles on lid and pan covered with permanent cool-touch material for easier handling
- ◆ Interior of pan, tray and cups feature PTFE/PFOA-free non-stick coating for easy release and cleaning
- ◆ Dishwasher safe

ITEM	DESCRIPTION	UOM	CASE
CEP-4	Pan, Lid & 4-Cup Set	Set	1/6



EGG POACHER SET



Set Includes:

- ◆ Steel sauce pan
- ◆ Glass cover
- ◆ Inner tray with 4 cups, each with cool-touch handles



CEP-4  

STAINLESS STEEL MIRROR-FINISH SAUCE PANS

- ◆ Triple-riveted handle

ITEM	DESCRIPTION	UOM	CASE
SAP-1.5	1-1/2 Qt	Each	12/36
SAP-2	2 Qt	Each	12/36

MIRRORED SAUCE PANS



SAP-2

DOUBLE POT HOOK

ITEM	DESCRIPTION	UOM	CASE
PH-2	Pot Hook	Each	24/240

DOUBLE POT HOOK



PH-2

STAINLESS STEEL DOUBLE BOILERS & PERF'D STEAMERS



SSDB-20



SSDB-20S



SSDB-SERIES
SSTC-SERIES



STAINLESS STEEL DOUBLE BOILERS & PERF'D STEAMERS

- ◆ 18/8 Stainless steel; tri-ply bottom
- ◆ Cover included

ITEM	DESCRIPTION	SIZE	UOM	CASE
SSDB-8	8 Qt Double Boiler	9-1/2" x 6-3/4" & 7-1/2"	Set	1/6
SSDB-12	12 Qt Double Boiler	10-1/4" x 8-1/2" & 9-3/8"	Set	1/6
SSDB-16	16 Qt Double Boiler	11" x 9-5/8" & 10-1/2"	Set	1/4
SSDB-20	20 Qt Double Boiler	11-7/8" x 10-5/8" & 11-1/2"	Set	1/4
SSDB-8S	8 Qt Steamer/ Pasta Cooker	9-1/2" x 6-3/4" & 7-1/2"	Set	1/6
SSDB-12S	12 Qt Steamer/ Pasta Cooker	10-1/4" x 8-1/2" & 9-3/8"	Set	1/6
SSDB-16S	16 Qt Steamer/ Pasta Cooker	11" x 9-5/8" & 10-1/2"	Set	1/4
SSDB-20S	20 Qt Steamer/ Pasta Cooker	11-7/8" x 10-5/8" & 11-1/2"	Set	1/4

REPLACEMENT COVERS

ITEM	DESCRIPTION	UOM	CASE
SSTC-8	Replacement Cover for 8 Qt	Each	6/12
SSTC-10	Replacement Cover for 12 Qt	Each	6
SSTC-12	Replacement Cover for 16 Qt	Each	6/12
SSTC-20	Replacement Cover for 20 Qt	Each	6/12

CARBON STEEL PANS



CSFP-11



CSFP-SERIES



CSPP-11

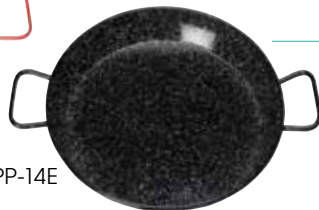

CSPP-14E



CSPP-35



POLISHED CARBON STEEL FRENCH-STYLE FRY PANS

Ideal for high-heat cooking and well suited for long pre-heating and searing.

- ◆ Made in Spain
- ◆ Sturdy, riveted handle
- ◆ **Hand wash**, dry immediately and completely; rub on light coat of cooking oil and store in dry, non-humid area

ITEM	DESCRIPTION	UOM	CASE
CSFP-7	7-7/8"	Each	5
CSFP-8	8-5/8"	Each	8
CSFP-9	9-1/2"	Each	7
CSFP-11	10-3/8"	Each	4
CSFP-12	11-1/8"	Each	3



CARBON STEEL PAELLA PANS

Create and display authentic paella dishes, roasting meat, stir-fry, and much more!

- ◆ Made in Spain
- ◆ **Hand wash**, dry thoroughly and store in dry area

ITEM	DESCRIPTION	FINISH	UOM	CASE
CSPP-7	7-7/8"	Polished	Each	12
CSPP-11	11"	Polished	Each	10
CSPP-14	14-1/8"	Polished	Each	5
CSPP-23	23-5/8"	Polished	Each	1
CSPP-35	35-1/2", 4 Hdls	Polished	Each	1
CSPP-11E	11"	Enameled	Each	10
CSPP-14E	14-1/8"	Enameled	Each	5
CSPP-23E	23-5/8"	Enameled	Each	1

MIRROR FINISH STAINLESS STEEL CHINESE WOKS

- ◆ Round bottom

ITEM	DESCRIPTION	UOM	CASE
WOK-14N	14" - Riveted Joint	Each	12
WOK-16N	16" - Riveted Joint	Each	12
WOK-14W	14" - Welded Handle	Each	12
WOK-16W	16" - Welded Handle	Each	12

WOKS & ACCESSORIES



Riveted Joint



WOK-16W

Round Bottom Woks



WOK-36

BLACK CARBON STEEL JAPANESE-STYLE WOKS

- ◆ Integrated 6" long handle with reinforcing welded joint
- ◆ 1.2 mm thickness

ITEM	DESCRIPTION	UOM	CASE
WOK-34	14"	Each	12
WOK-36	16"	Each	12



WKCS-14



WKR-8

STAINLESS STEEL WOK COVERS

ITEM	DESCRIPTION	UOM	CASE
WKCS-14	13-3/4"	Each	12/60
WKCS-15	15-3/8"	Each	12/48
WKCS-18	17-3/4"	Each	12/36

STAINLESS STEEL WOK RING STAND

ITEM	DESCRIPTION	UOM	CASE
WKR-8	8"	Each	12/120



DELUXE HARD-ANODIZED ALUMINUM GRIDDLE

- ◆ Great for use on all kinds of ranges
- ◆ Convert open range-top to griddle surface
- ◆ Raised handles are silicone wrapped, preventing heat transfer; provide easy transport

ITEM	DESCRIPTION	UOM	CASE
HAG-2012	19-5/8"L x 12-1/4"W	Each	1/6

GRIDDLES



HAG-2012



Flat griddle side

IGD-2095



REVERSIBLE CAST IRON GRILL/GRIDDLE

- ◆ Ribbed grill surface on one side, flat griddle on the other
- ◆ Pre-seasoned

ITEM	DESCRIPTION	UOM	CASE
IGD-2095	20"L x 9-1/2"W	Each	4

FAJITA SERVERS

- ◆ Attractive wooden underliner provides protective barrier between tabletop and hot platter; resists splitting or cracking under hot cast iron pan



ITEM	DESCRIPTION	UOM	CASE
FS-2	Fajita Server, 2-pc Set	Set	1/12
FS-2-UL	Replacement Underliner for FS-2	Each	12
ISP-3	Steak Platter with Gripper, 3-Pc Set	Set	1/12
ISP-3-UL	Replacement Underliner for ISP-3	Each	12

FAJITA SERVERS



FS-2

ISP-3

SKILLET/PAN HANDLE SLEEVES

- ◆ Heat-resistant up to 250°F (120°C)

ITEM	DESCRIPTION	SIZE	UOM	CASE
HDH-6C	Chili Peppers Cotton Sleeve	3-1/2" x 6-1/2"	Doz	1/24
HDH-7S	Cotton Sleeve	3-1/2" x 6-1/2"	Doz	1/24

PAN HANDLE SLEEVES



HDH-6C



HDH-7S





GET COOKING WITH CAST

Cookware that gets better with age!

Our FireIron™ Cast collection is the perfect kitchen tool that can handle any commercial kitchen cooktop. The full-size cast iron pans come seasoned and ready to use, right out of the box!



Compatible with multiple cooking surfaces

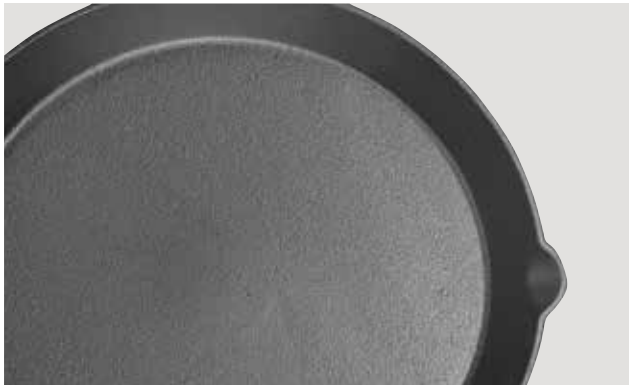

SAUTÉ, FRY, BOIL, BRAISE, BAKE, ROAST

Cook with confidence!

Achieve an excellent sear on the fine, smooth surface.



EASY HANDLING

Wide handles to easily grasp and maneuver



COMFORT GRIP

Thumbrest for comfortable grip when handling

FIREIRON™ CAST IRON COOKWARE

Designed to last for generations, FireIron™ cast iron pans are pre-seasoned and induction ready. Great for kitchen-to-table service.

- ◆ Fine, smooth surface for excellent sear; also sauté, fry, boil, braise, bake, and roast
- ◆ Wide-grip dual handles with thumbrest for comfortable grip and better handling

CAST IRON COOKWARE & WOOD UNDERLINERS



CASD-12

Pre-Seasoned
CASD-SERIES



FIREIRON™ CAST IRON SKILLETTS WITH DUAL HANDLES

ITEM	DESCRIPTION	UOM	CASE
CASD-8	8" Dia	Each	6
CASD-10	10" Dia	Each	4
CASD-12	12" Dia	Each	4



CAGP-10R

FIREIRON™ CAST IRON GRILL PANS W/ HELPER HANDLE

ITEM	DESCRIPTION	UOM	CASE
CAGP-10R	10-1/4" Dia	Each	4
CAGP-10S	10-1/2" Square	Each	4



CAGP-10S

Pre-Seasoned
CAGP-SERIES



FIREIRON™ CAST IRON SKILLETTS

ITEM	DESCRIPTION	UOM	CASE
CAST-6	6"	Each	6
CAST-8	8"	Each	6
CAST-10	10" with Helper Handle	Each	4
CAST-12	12" with Helper Handle	Each	4



CAST-6 with CAST-6UL



Pre-Seasoned
CAST-SERIES SKILLETTS



FIREIRON™ CAST IRON WOOD UNDERLINERS

- ◆ Dual contoured handles for secure grip to safely transport hot skillets
- ◆ Protect table/countertop surfaces from heat damage
- ◆ Hand wash only

ITEM	DESCRIPTION	UOM	CASE
CAST-6UL	Fits CAST-6	Each	12/48
CAST-8UL	Fits CAST-8	Each	12/48



CAST-8UL



CAST-6UL

ROUND CAST IRON GRILL PAN

ITEM	DESCRIPTION	UOM	CASE
IGL-10	10", Black Coating	Each	8



IGL-10



ALUMINUM COOKWARE



Fry Pans | Sauce Pots | Braziers | Stock Pots | Sauté Pans

**INDUCTION
READY**



GLADIATOR™

with



Non-stick

**SUPERIOR strength
& scratch resistance,
excellent release**

#1 choice of
professional chefs

PFOA
FREE





Excellent quality for the price

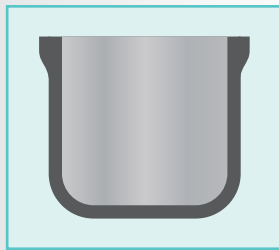

Strong and durable structure with reinforced edges



Ergonomic, sturdy handles for comfort



3003 aluminum for fast and even heat distribution, no hot spots

3003 ELEMENTAL ALUMINUM

6.0 mm, 1/4" thickness

4.0 mm, 3/16" thickness



MAJESTIC™

with



Non-stick

Strong, durable, scratch resistant, clean release



PFOA FREE

INDUCTION READY ALUMINUM COOKWARE



Induction ready pot/pan base



AFPI-10H



AFPI-10NH



AFPI-SERIES



NON-STICK FRY PANS

Hybrid technology bonds a stainless steel plate to aluminum cookware, as effective in utilizing induction technology as full stainless steel cookware.

- ◆ Deep drawn 3003 Aluminum body is durable and highly conductive, better than stainless steel cookware for quickly and evenly distributing heat
- ◆ Stainless steel bonded plate allows for magnetic contact with induction cooktops
- ◆ Thicker handles and heavier rivets than standard cookware allow for secure comfort in transporting cookware
- ◆ Can also be safely used with gas or electric ranges



NATURAL FINISH INDUCTION READY ALUMINUM FRY PANS

- ◆ Ergonomic comfort handle is heat resistant to 500°F (260°C)

ITEM	DESCRIPTION	PLATE SIZE	UOM	CASE
AFPI-8H*	8"Dia	5"	Each	6
AFPI-10H	10"Dia	6-1/4"	Each	6
AFPI-12H	12"Dia	6-7/8"	Each	6

*Compatible with all Winco® induction cookers. (May not be compatible with all induction cookers on the market.)



NON-STICK INDUCTION READY ALUMINUM FRY PANS

- ◆ Quantum2® non-stick finish bonds to the aluminum for long-lasting, scratch-resistance
- ◆ Ergonomic comfort handle is heat resistant to 500°F (260°C)

ITEM	DESCRIPTION	PLATE SIZE	UOM	CASE
AFPI-8NH*	8"Dia	5"	Each	6
AFPI-10NH	10"Dia	6-1/4"	Each	6
AFPI-12NH	12"Dia	6-7/8"	Each	6

*Compatible with all Winco® induction cookers. (May not be compatible with all induction cookers on the market.)

Compatible with induction cooktops



INDUCTION READY SAUTÉ PAN

- ◆ Thicker handle and heavier rivets than standard cookware allow for secure comfort when lifting and carrying
- ◆ 3003 Aluminum, 4.0mm, 3/16" thick

ITEM	DESCRIPTION	PLATE SIZE	UOM	CASE
AXTI-3	3 Qt	7-1/2"	Each	6



AXTI-3

COVERS FOR ALUMINUM FRY PANS

ALPC-20



ASP-2C
ALPC-SERIES

COVERS FOR ALUMINUM FRY PANS

ITEM	DESCRIPTION	UOM	CASE
ASP-2C	For 8" Fry Pan	Each	12
ALPC-8SC	For 10" Fry Pan	Each	6
ALPC-20	For 12" Fry Pan	Each	6
ALPC-32	For 14" Fry Pan	Each	6

Constructed of 3003 series aluminum alloy with riveted heavy weight handles, the Gladiator fry pans will keep up with the rigorous demands of a commercial kitchen, in addition to providing excellent heat distribution for searing, browning and frying.

- ◆ 3.5mm thickness

GLADIATOR™ NATURAL FINISH

ITEM	DESCRIPTION	UOM	CASE
AFP-7A	7"Dia	Each	6
AFP-8A	8"Dia	Each	6
AFP-10A	10"Dia	Each	6
AFP-12A	12"Dia	Each	6
AFP-14A	14"Dia	Each	6
AFP-7A-H	7"Dia with Sleeve	Each	6
AFP-8A-H	8"Dia with Sleeve	Each	6
AFP-10A-H	10"Dia with Sleeve	Each	6
AFP-12A-H	12"Dia with Sleeve	Each	6
AFP-14A-H	14"Dia with Sleeve	Each	6

GLADIATOR™ EXCALIBUR® NON-STICK

- ◆ Excalibur® non-stick finish bonds to the aluminum for a long lasting, scratch-resistant finish

ITEM	DESCRIPTION	UOM	CASE
AFP-7XC	7"Dia	Each	6
AFP-8XC	8"Dia	Each	6
AFP-10XC	10"Dia	Each	6
AFP-12XC	12"Dia	Each	6
AFP-14XC	14"Dia	Each	6
AFP-7XC-H	7"Dia with Sleeve	Each	6
AFP-8XC-H	8"Dia with Sleeve	Each	6
AFP-10XC-H	10"Dia with Sleeve	Each	6
AFP-12XC-H	12"Dia with Sleeve	Each	6
AFP-14XC-H	14"Dia with Sleeve	Each	6

- ◆ Made of 3003 aluminum alloy, the Majestic™ fry pans offer exceptional performance at a great value
- ◆ Available in three finishes: Majestic™ mirror, Majestic™ satin & Majestic™ Quantum2® non-stick
- ◆ 3.5mm thickness

MAJESTIC™ SATIN FINISH

ITEM	DESCRIPTION	UOM	CASE
AFP-7S	7"Dia	Each	6
AFP-8S	8"Dia	Each	6
AFP-10S	10"Dia	Each	6
AFP-12S	12"Dia	Each	6
AFP-14S	14"Dia	Each	6

MAJESTIC™ MIRROR FINISH

ITEM	DESCRIPTION	UOM	CASE
AFP-7	7"Dia	Each	6
AFP-8	8"Dia	Each	6
AFP-10	10"Dia	Each	6
AFP-12	12"Dia	Each	6
AFP-14	14"Dia	Each	6

MAJESTIC™ QUANTUM2® NON-STICK

ITEM	DESCRIPTION	UOM	CASE
AFP-7NS	7"Dia	Each	6
AFP-8NS	8"Dia	Each	6
AFP-10NS	10"Dia	Each	6
AFP-12NS	12"Dia	Each	6
AFP-14NS	14"Dia	Each	6
AFP-7NS-H	7"Dia with Sleeve	Each	6
AFP-8NS-H	8"Dia with Sleeve	Each	6
AFP-10NS-H	10"Dia with Sleeve	Each	6
AFP-12NS-H	12"Dia with Sleeve	Each	6
AFP-14NS-H	14"Dia with Sleeve	Each	6

GLADIATOR™ FRY PANS

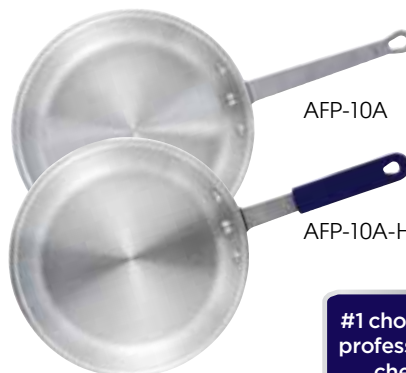

AFP-10A

AFP-10A-H



AFP-10XC

AFP-10XC-H



MAJESTIC™ FRY PANS



AFP-8S

AFP-10

Silicone sleeves available

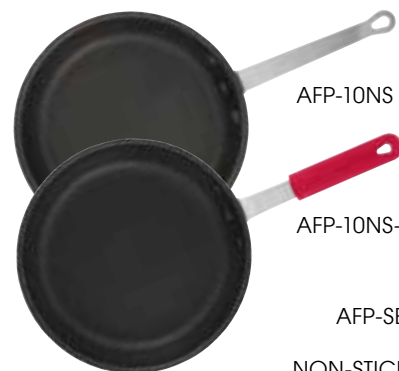

AFP-10NS

AFP-10NS-H





Sturdy handles

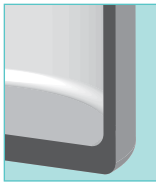

Extra thick reinforced base



ALBH-28



ASHP-60



ALHP-120

ELEMENTAL ALUMINUM EXTRA-HEAVYWEIGHT COOKWARE

6.0 MM, 1/4" THICKNESS

- ◆ Extra-durable 6mm thick aluminum core ensures long-lasting performance through constant heating & washing
- ◆ 3003 Aluminum for superior heat distribution
- ◆ Riveted handles designed for strength & durability
- ◆ Wide base & high walls allow for recipe versatility

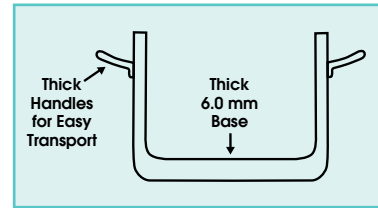

NSF 3003 ELEMENTAL ALUMINUM COOKWARE

EXTRA HEAVYWEIGHT ALUMINUM STOCK POTS

ITEM	DESCRIPTION	SIZE (DIA X HEIGHT)	UOM	CASE
ALHP-12	12 Qt	10-1/8" x 9-3/8"	Each	1
ALHP-16	16 Qt	11-3/8" x 10-1/4"	Each	1
ALHP-20	20 Qt	12-1/8" x 10-1/2"	Each	1
ALHP-24	24 Qt	12-1/8" x 11-3/8"	Each	1
ALHP-32	32 Qt	14-1/8" x 13"	Each	1
ALHP-40	40 Qt	14-3/4" x 14-1/2"	Each	1
ALHP-60	60 Qt	16-1/4" x 17-3/8"	Each	1
ALHP-80	80 Qt	19-1/4" x 17"	Each	1
ALHP-100	100 Qt	20-1/4" x 18-3/8"	Each	1
ALHP-120	120 Qt, 4 Hdls	21-5/8" x 19-1/2"	Each	1
ALHP-140	140 Qt, 4 Hdls	23-5/8" x 19-5/8"	Each	1
ALHP-160	160 Qt, 4 Hdls	23-5/8" x 21-7/8"	Each	1

Replaces AXHH-Series

COVERS

ITEM	UOM	CASE
ALPC-10	Each	6
ALPC-16	Each	6
ALPC-20	Each	6
ALPC-24	Each	6
ALPC-32	Each	6
ALPC-40	Each	6
ALPC-50	Each	6
ALPC-80	Each	6
ALPC-100	Each	6
ALPC-35BC	Each	6
ALPC-140	Each	6
ALPC-140	Each	6

Replaces AXS-Series

EXTRA HEAVYWEIGHT ALUMINUM SAUCE POTS

ITEM	DESCRIPTION	SIZE (DIA X HEIGHT)	UOM	CASE
ASHP-08	8 Qt	10-3/8" x 6-1/4"	Each	1
ASHP-14	14 Qt	12-1/8" x 7-1/2"	Each	1
ASHP-20	20 Qt	13-1/4" x 9"	Each	1
ASHP-26	26 Qt	14-1/8" x 10"	Each	1
ASHP-34	34 Qt	16-1/4" x 9-7/8"	Each	1
ASHP-40	40 Qt	18-1/4" x 10"	Each	1
ASHP-60	60 Qt	20" x 11-1/8"	Each	1

Replaces AXHA-Series

COVERS

ITEM	UOM	CASE
ALPC-8SC	Each	6
ALPC-20	Each	6
ALPC-20SC	Each	6
ALPC-32	Each	6
ALPC-50	Each	6
ALPC-40SC	Each	6
ALPC-100	Each	6

Replaces AXS-Series

EXTRA HEAVYWEIGHT ALUMINUM BRAZIER

ITEM	DESCRIPTION	SIZE (DIA X HEIGHT)	UOM	CASE
ALBH-15	15 Qt	14-1/8" x 5-3/8"	Each	1
ALBH-18	18 Qt	16-1/4" x 5-3/8"	Each	1
ALBH-24	24 Qt	18-1/4" x 5-3/8"	Each	1
ALBH-28	28 Qt	20-1/4" x 5-1/2"	Each	1
ALBH-35	35 Qt	22" x 5-1/2"	Each	1
ALBH-40	40 Qt	23-1/8" x 5-1/2"	Each	1

Replaces AXHB-Series

COVERS

ITEM	UOM	CASE
ALPC-32	Each	6
ALPC-50	Each	6
ALPC-40SC	Each	6
ALPC-100	Each	6
ALPC-35BC	Each	6
ALPC-40BC	Each	6

Replaces AXS-Series



ALST-80



ASSP-40



Sturdy handles

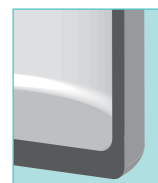

Extra thick reinforced base



ASET-5

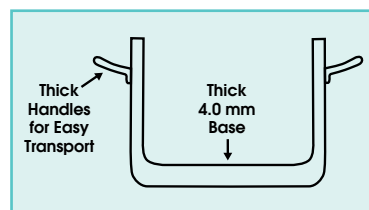

ELEMENTAL ALUMINUM HEAVYWEIGHT COOKWARE

4.0 MM, 3/16" THICKNESS

- ◆ Durable 4mm thick aluminum core ensures long-lasting performance with constant heating & washing
- ◆ 3003 Aluminum for superior heat distribution
- ◆ Riveted handles designed for strength & durability
- ◆ Wide base & high walls allow for recipe versatility

3003 ELEMENTAL ALUMINUM COOKWARE 

HEAVYWEIGHT ALUMINUM STOCK POTS

ITEM	DESCRIPTION	SIZE (DIA X HEIGHT)	UOM	CASE
ALST-8	8 Qt	9-3/8" x 7-1/2"	Each	1
ALST-10	10 Qt	10-1/8" x 8-1/4"	Each	1
ALST-12	12 Qt	10-1/8" x 9-3/8"	Each	1
ALST-16	16 Qt	11-3/8" x 10-1/4"	Each	1
ALST-20	20 Qt	12-1/8" x 10-1/2"	Each	1
ALST-24	24 Qt	13" x 11-3/8"	Each	1
ALST-32	32 Qt	14-1/8" x 13"	Each	1
ALST-40	40 Qt	14-3/4" x 14-1/2"	Each	1
ALST-50	50 Qt	16-1/4" x 15"	Each	1
ALST-60	60 Qt	16-1/4" x 17-3/8"	Each	1
ALST-80	80 Qt	19-1/4" x 17"	Each	1
ALST-100	100 Qt	20-1/4" x 18-3/8"	Each	1

Replaces AXS-Series

HEAVYWEIGHT ALUMINUM SAUCE POTS

ITEM	DESCRIPTION	SIZE (DIA X HEIGHT)	UOM	CASE
ASSP-08	8 Qt	10-3/8" x 6-1/4"	Each	1
ASSP-14	14 Qt	12-1/8" x 7-1/2"	Each	1
ASSP-20	20 Qt	13-1/4" x 9"	Each	1
ASSP-26	26 Qt	14-1/8" x 10"	Each	1
ASSP-34	34 Qt	16-1/4" x 9-7/8"	Each	1
ASSP-40	40 Qt	18-1/4" x 10"	Each	1

Replaces AXAP-Series

HEAVYWEIGHT ALUMINUM BRAZIER

ITEM	DESCRIPTION	SIZE (DIA X HEIGHT)	UOM	CASE
ALB-15	15 Qt	14-1/8" x 5-3/8"	Each	1
ALB-18	18 Qt	16-1/4" x 5-3/8"	Each	1
ALB-24	24 Qt	18-1/4" x 5-3/8"	Each	1
ALB-28	28 Qt	20-1/4" x 5-1/2"	Each	1
ALB-35	35 Qt	22" x 5-1/2"	Each	1
ALB-40	40 Qt	23-1/8" x 5-1/2"	Each	1

Replaces AXBZ-Series

HEAVYWEIGHT ALUMINUM SAUTÉ PANS

ITEM	DESCRIPTION	SIZE	UOM	CASE
ASET-3	3 Qt	10-3/8" x 2-5/8"	Each	6
ASET-5	5 Qt	12-3/8" x 2-7/8"	Each	6
ASET-7	7 Qt	14-1/4" x 2-7/8"	Each	6

Replaces AXST-Series

COVERS

ITEM	UOM	CASE
ALPC-8	Each	6
ALPC-10	Each	6
ALPC-10	Each	6
ALPC-16	Each	6
ALPC-20	Each	6
ALPC-24	Each	6
ALPC-32	Each	6
ALPC-40	Each	6
ALPC-50	Each	6
ALPC-50	Each	6
ALPC-80	Each	6
ALPC-100	Each	6

Replaces AXS-Series

COVERS

ITEM	UOM	CASE
ALPC-8SC	Each	6
ALPC-20	Each	6
ALPC-20SC	Each	6
ALPC-32	Each	6
ALPC-50	Each	6
ALPC-40SC	Each	6

Replaces AXS-Series

COVERS

ITEM	UOM	CASE
ALPC-32	Each	6
ALPC-50	Each	6
ALPC-40SC	Each	6
ALPC-100	Each	6
ALPC-35BC	Each	6
ALPC-40BC	Each	6

Replaces AXS-Series

COVERS

ITEM	UOM	CASE
ALPC-8SC	Each	6
ALPC-20	Each	6
ALPC-32	Each	6

Replaces AXS-Series

HEAVY-DUTY ALUMINUM TAPERED SAUCE PANS



ASP-5

ASP-5C

NSF ASP-SERIES



ALUMINUM TAPERED SAUCE PANS

- ◆ 3003 Aluminum, 3.0mm thickness
- ◆ Flared sides for easier stirring and churning

ITEM	DESCRIPTION	SIZE (DIA X H)	UOM	CASE
ASP-1	1-1/2 Qt	6-1/8" x 4-1/8"	Each	12
ASP-2	2-1/2 Qt	8" x 4-1/2"	Each	12
ASP-3	3-3/4 Qt	8-7/8" x 4-1/2"	Each	12
ASP-4	4-1/4 Qt	9-1/4" x 5"	Each	12
ASP-5	5 Qt	10-1/8" x 5-1/2"	Each	12
ASP-7	7 Qt, Help Hdl	10-3/4" x 5-1/2"	Each	6
ASP-10	10 Qt, Help Hdl	11-1/2" x 5-3/4"	Each	6

COVERS

ITEM	DESCRIPTION	UOM	CASE
ASP-1C	Cover for 1-1/2 Qt	Each	12
ASP-2C	Cover for 2-1/2 Qt	Each	12
ASP-3C	Cover for 3-3/4 Qt	Each	12
ASP-4C	Cover for 4-1/4 Qt	Each	12
ASP-5C	Cover for 5 Qt	Each	12
ASP-7C	Cover for 7 Qt	Each	12
ASP-10C	Cover for 10 Qt	Each	12

PAN HANDLE SLEEVES



PH-811W



PAN GRABBER MITT

- ◆ Heat-resistant up to 400°F (205°C)
- ◆ Comfortable elastic wrist strap assists while handling hot baking sheets or pan handles

ITEM	DESCRIPTION	SIZE	UOM	CASE
PH-811W	Terry Cloth Mitt	11"L x 8"W	Doz	15

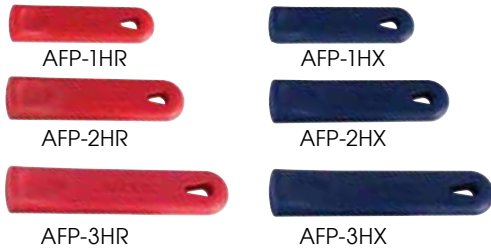

AFP-1HR

AFP-1HX

AFP-2HR

AFP-2HX

AFP-3HR

AFP-3HX



AFP-10HP

REMOVABLE SILICONE SLEEVES FOR FRY & SAUCE PANS

- ◆ Heat-resistant up to 450°F (230°C)

ITEM	DESCRIPTION	COLOR	UOM	CASE
AFP-1HR	Fits AFP-7, -8, ASP-1, -2	Red	Each	12/120
AFP-2HR	Fits AFP-10, -12, ASP-3, -4, -5, -7, ASFP-11, AXST-3	Red	Each	12/120
AFP-3HR	Fits AFP-14, ASP-10, AXST-5, -7	Red	Each	12/120
AFP-1HX	Fits AFP-7, -8, ASP-1, -2	Blue	Each	12/120
AFP-2HX	Fits AFP-10, -12, ASP-3, -4, -5, -7, ASFP-11, AXST-3	Blue	Each	12/120
AFP-3HX	Fits AFP-14, ASP-10, AXST-5, -7	Blue	Each	12/120
AFP-10HP	Fits AFP-10, ASFP-11, ASP-3, -4	Purple	Each	1/120

POT SCRUBBING BRUSHES



BRN-20P

BRN-8P

NYLON BRISTLE POT SCRUBBING BRUSHES

ITEM	DESCRIPTION	UOM	CASE
BRN-8P	8" Nylon Brush	Each	12/72
BRN-20P	20" Nylon Brush	Each	12/72



BRP-20

BRP-10

COIR BRISTLE POT SCRUBBING BRUSHES

ITEM	DESCRIPTION	UOM	CASE
BRP-10	10" Coir BRush	Each	12/72
BRP-20	20" Coir Brush	Each	6/48

HEAVY-DUTY ALUMINUM SHEET PANS

- ◆ Closed bead with galvanized wire for rust resistance and reinforcement - resists warping
- ◆ Made of 3003 aluminum

ITEM	DESCRIPTION	SIZE	GAUGE	UOM	CASE
ALXP-1200	Full-Size Open Bead, NSF	18" x 26"	12	Each	12
ALXP-2618H	Full-Size Closed Bead	18" x 26"	16	Each	12

HEAVY-DUTY ALUMINUM SHEET PANS



ALXP-1200 (OPEN BEAD) NSF



HEAVY-DUTY ALUMINUM DOUBLE ROASTERS

- ◆ Lock in steam and enhance flavors
- ◆ Straps add strength and lugs hold cover in place when used together
- ◆ 10 gauge aluminum

ITEM	DESCRIPTION	SIZE	UOM	CASE
ALRP-1824	Roaster with Straps and Handles	24"L x 18"W x 4-1/2"H	Each	2
ALRP-1824L	Roaster with Straps, Lugs and Handles	24"L x 18"W x 4-1/2"H	Each	2

ALUMINUM ROASTING PANS



ALRP-1824



ALRP-1824L



HEAVY-DUTY ALUMINUM BAKING/ROASTING PANS

- ◆ 12 gauge aluminum

ITEM	DESCRIPTION	SIZE	UOM	CASE
ALRP-1826	Pan without Handles	25-3/4"L x 17-3/4"W x 2-1/4"H	Each	3
ALRP-1826H	Pan with Handles	25-3/4"L x 17-3/4"W x 3-1/2"H	Each	3

Refer to Food Temperature Measurement for the full range of thermometers



ALRP-1826H



ALRP-1826

ALUMINUM BAKING/ROASTING PAN

- ◆ Dual drop handles

ITEM	DESCRIPTION	SIZE	UOM	CASE
ALBP-1218	Pan with Handles	17-3/4"L x 11-1/2"W x 2-1/4"H	Each	6/24



ALBP-1218



ALUMINUM GYRO PAN



AGP-10

Curved front fits right up to vertical spit



10" ALUMINUM GYRO PAN

The perfect pan for catching meat that is carved off of a gyro cone when rotating on a vertical broiler.

- ◆ Ergonomically designed, insulated silicone handle is heat-resistant up to 450°F (230°C)

ITEM	DESCRIPTION	UOM	CASE
AGP-10	10" Gyro Pan	Each	12

ALUMINUM STIR FRY PANS



ASFP-11



ASFP-11NS



ASFP-SERIES



ASFP-11NS



ALUMINUM STIR FRY PANS

- ◆ 3003 Aluminum, 4.0mm thickness
- ◆ Ergonomic, heat-resistant silicone handle

ITEM	DESCRIPTION	SIZE (DIA X H)	UOM	CASE
ASFP-11	Natural Finish	11" x 3-5/8"	Each	6
ASFP-11NS	Non-stick, Quantum2® Coating	11" x 3-5/8"	Each	6

ALUMINUM PASTA COOKER



APS-20

ALUMINUM PASTA COOKER SET

- ◆ Heavyweight 3003 aluminum pot, 3.5mm
- ◆ Includes 4 stainless steel inserts, 0.7mm thick
- ◆ Handles are heat-resistant up to 500°F (260°C)



ITEM	DESCRIPTION	UOM	CASE
APS-20	20 Qt Pasta Cooker Set	Set	1
APS-INS	Quarter-Size S/S Inset	Each	4
APS-PT	Replacement Pot	Each	1



ALUMINUM STEAMER BASKETS



ALSB-32

ALUMINUM STEAMER BASKETS

ITEM	DESCRIPTION	UOM	CASE
ALSB-20	20 Qt Fits ALHP-20 & ALST-20	Each	1
ALSB-32	32 Qt Fits ALHP-32 & ALST-32	Each	1
ALSB-40	40 Qt Fits ALHP-40 & ALST-40	Each	1
ALSB-60	60 Qt Fits ALHP-60 & ALST-60	Each	1
ALSB-80	80 Qt Fits ALHP-80 & ALST-80	Each	1

WIRE STEAMER RACKS



STR-15

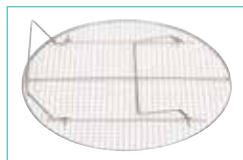

NICKEL-PLATED WIRE STEAMER RACKS

- ◆ Built-in feet fold down for compact storage

ITEM	DESCRIPTION	SIZE	UOM	CASE
STR-10	Round	10-3/4"	Each	10
STR-13	Round	12-3/4"	Each	10
STR-15	Round	14-3/4"	Each	10
STR-18	Round	17-3/4"	Each	10

Extra-heavyweight premium pasta baskets stand up to constantly knocking the edges when removing pasta. Water flows freely through the cylindrical design for even cooking. Hang-dry with the open-end handles. Most pasta cooker machines and standard stock pots will accommodate these baskets.

PASTA BASKETS



SUPER-FINE 18/8 STAINLESS STEEL MESH PASTA BASKETS

- ◆ Corrosion resistant electro-plating; reinforced frame
- ◆ Designed specifically for fine pastas, such as capellini and linguine

ITEM	DESCRIPTION	UOM	CASE
MPF-57	5"Dia x 7"H, Short	Each	1/8
MPF-59	5"Dia x 9"H, Tall	Each	1/8
MPF-67	6-1/2"Dia x 7"H, Wide	Each	1/8



18/8 STAINLESS STEEL MESH PASTA BOIL BASKETS

- ◆ Standard size mesh for cooking a variety of pastas

ITEM	DESCRIPTION	UOM	CASE
MPN-57	5-1/4" Dia x 7"H, Short	Each	2/8
MPN-59	5" Dia x 9"H, Tall	Each	2/8
MPN-67	6-1/2" Dia x 7"H, Wide	Each	2/6

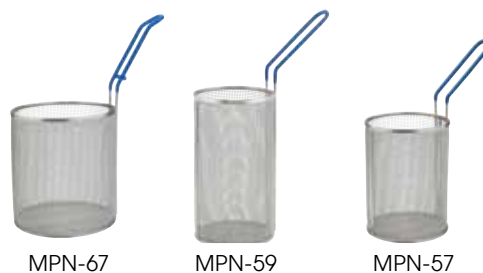

18/8 STAINLESS STEEL BULK PASTA/IMMERSION BASKET

- ◆ Plastic coated handles rated for temperatures up to 250°F (120°C)
- ◆ Suitable for cooking most types of pasta in bulk
- ◆ Fits standard cookers

ITEM	DESCRIPTION	UOM	CASE
MPN-1613	16-1/4"L x 12-7/8"W x 10"H	Each	2



TAPERED ALUMINUM FRYER POTS

- ◆ Use hook on front of pan to secure fry basket to pot

ITEM	DESCRIPTION	SIZE	UOM	CASE
ALSP-5	5.5 Qt	10-1/8"Dia x 5-1/2"H	Each	6
ALSP-7	7 Qt	10-3/4"Dia x 5-1/2"H	Each	6
ALSP-10	10 Qt	11-1/2"Dia x 5-3/4"H	Each	6

FRYER/PASTA COMBINATION PANS



NICKEL-PLATED 6MM WIRE MESH ROUND FRY BASKETS

- ◆ 1/8" mesh, ideal for small batch cooking/straining

ITEM	DESCRIPTION	HANDLE	UOM	CASE
FBRS-8	8-11/16"Dia x 4-15/16"H	7-1/4"	Each	20
FBRS-9	9-5/8"Dia x 4-15/16"H	7-1/4"	Each	20
FBRS-11	10-7/16"Dia x 5-5/16"H	9"	Each	20



NICKEL-PLATED 4MM WIRE MESH ROUND FRY BASKETS

- ◆ 1/4" mesh, ideal for small batch cooking/straining

ITEM	DESCRIPTION	HANDLE	UOM	CASE
FBR-8	8-1/2"Dia x 4-1/4"H	7-1/2"	Each	20
FBR-9	9-1/2"Dia x 5-3/4"H	8"	Each	20
FBR-11	10-1/2"Dia x 6"H	9"	Each	20



Winco® Fry Baskets Anatomy

STRUCTURE

**NICKEL PLATED
NON-WELDED, ONE-PIECE CONSTRUCTION**

Strong corners reinforced with heavy-gauge wire

ONE PIECE from handle to hook



Heavy-gauge wire handle

High-temperature resistant colored plastic coating

DIMENSIONS

**STANDARD
FRY BASKET**

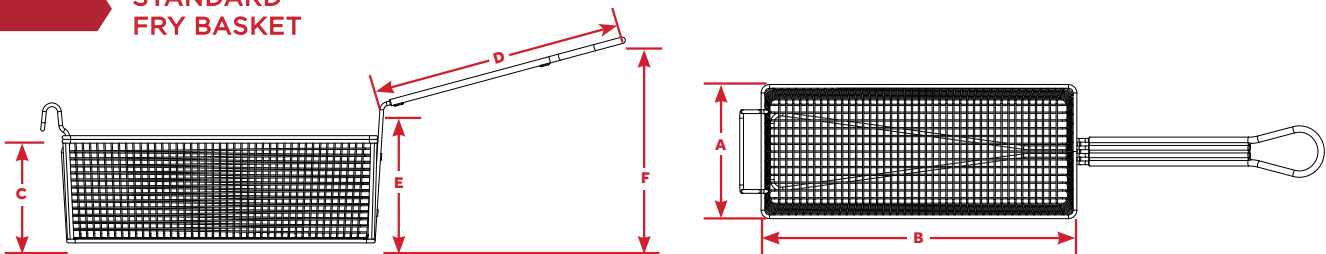

**CHIMICHANGA/BURRITO
FRY BASKET**

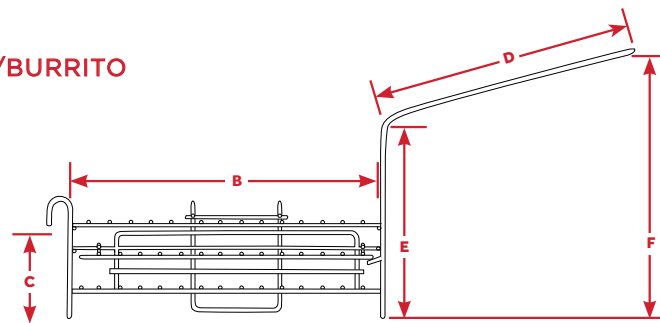

MODEL NO.	PRODUCT NAME	DIMENSIONS (IN.)					
		Length B	Width A	Height C	Handle D	Handle E	Handle F
FB-03	Chimichanga/Burrito Fry Basket	11-1/2	6	3-7/8 (4-5/8 with hook)	8	8-1/4	12
FB-05	Fry Basket	11	5-3/8	4-1/4	10-1/2	6-1/4	8-1/2
FB-10	Fry Basket	12-1/4	6-1/2	5-1/4	10-1/2	9-1/4	11-1/2
FB-20	Fry Basket	13-1/4	5-3/4	5-5/8	10-1/2	9-1/4	10-3/4
FB-25	Fry Basket	12-7/8	6-5/8	5-1/4	10-1/2	9	10-1/8
FB-30	Fry Basket	13-1/4	6-1/2	6	10-1/2	9	11
FB-35	Fry Basket	13-3/8	9-1/2	6-1/8	10-1/2	9-1/4	11-1/4
FB-40	Fry Basket	17	8-3/8	6	12	8	10-7/8

NICKEL PLATED FRY BASKETS

- ◆ One-piece construction, non-welded structure
- ◆ Reinforced, strong, long-lasting frame
- ◆ Heavy gauge wire handles with high-temperature resistant colored plastic coating

ITEM	DESCRIPTION	COLOR	UOM	CASE
FB-05	11" x 5-3/8" x 4-1/4", 10-1/2" Handle	Black	Each	6
FB-10	12-1/4" x 6-1/2" x 5-1/4", 10-1/2" Handle	Orange	Each	6
FB-20	13-1/4" x 5-3/4" x 5-5/8", 10-1/2" Handle	Blue	Each	6
FB-25	12-7/8" x 6-5/8" x 5-1/4", 10-1/2" Handle	Red	Each	6
FB-30	13-1/4" x 6-1/2" x 6", 10-1/2" Handle	Green	Each	6
FB-35	13-3/8" x 9-1/2" x 6-1/8", 10-1/2" Handle	Grey	Each	6
FB-40	17" x 8-3/8" x 6", 12" Handle	Yellow	Each	6

FRY BASKETS

Refer to www.wincous.com for fit guide

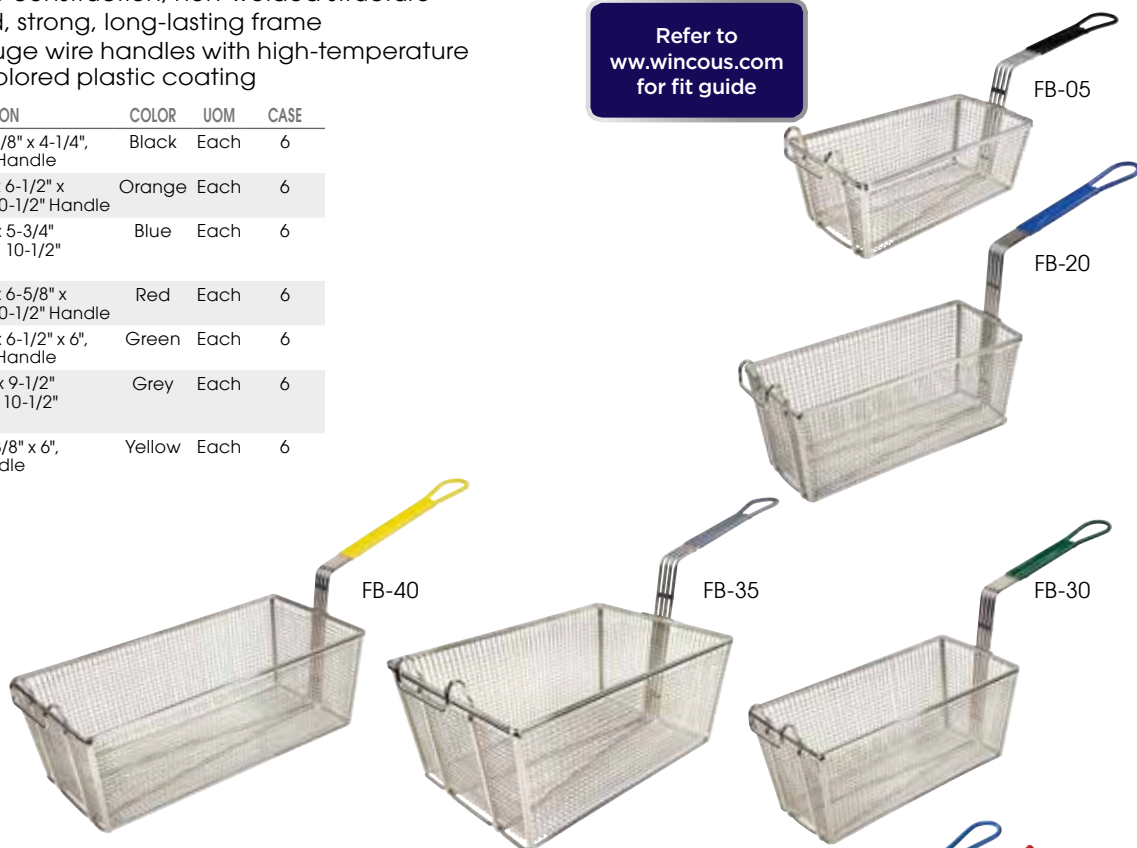

Packaging lists the models that each FB- item fits

SPECIALTY FRY BASKETS

- ◆ Heavy gauge wire handle coated with high-temperature resistant colored plastic
- ◆ Commercial quality 18/8 stainless steel

ITEM	DESCRIPTION	UOM	CASE
CKCF-BSK	8 Slots, Front Hook, 12-1/4" x 5-3/4" x 3-1/4" w/o hook, 10-1/2"L Handle	Each	10
FB-03	2 Hinged Shelves, Front & Side Hooks, 11-1/2" x 6" x 3-7/8" w/o hook, 8"L Handle	Each	6

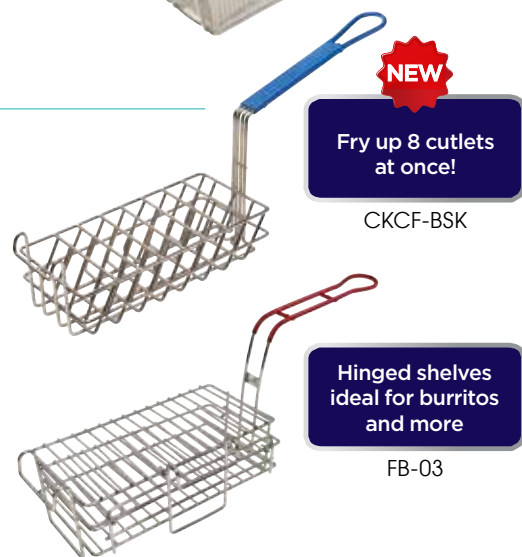

Fry up 8 cutlets at once!

CKCF-BSK

Hinged shelves ideal for burritos and more

FB-03

CHROME-PLATED TORTILLA SHELL FRY BASKET

ITEM	DESCRIPTION	UOM	CASE
TB-25	25" Long Handle, 6-1/4" Dia Basket	Each	8

NICKEL-PLATED TACO & TOSTADA BASKETS

ITEM	DESCRIPTION	UOM	CASE
TB-22	18" Hdl, Triangle Basket	Each	12
TB-20	18" Hdl, Round Basket	Each	12
TB-18	Tostada Basket, Eighteen 6" Tostada Shells	Each	8
TB-8	Taco Basket, Eight 6" Taco Shells	Each	8



FRY BASKET DIVIDER & PRESSES



Divide fry baskets for smaller batches
Shown with FB-25



FB-DIV

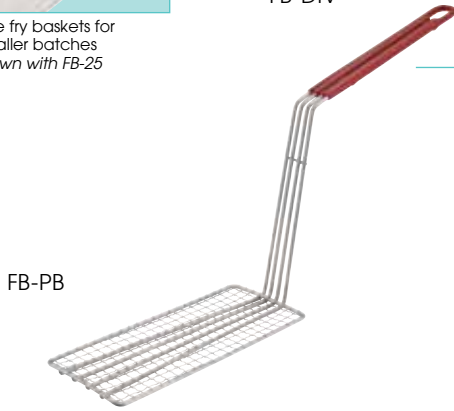

FB-PB



FRY BASKET DIVIDER

- ◆ Handle is removable for easy cleaning
- ◆ Divide a fryer basket into multiple compartments for small-batch, portioned frying
- ◆ Fits Winco® fry basket models FB-10, FB-25, FB-30 (6-1/2"W)

ITEM	DESCRIPTION	UOM	CASE
FB-DIV	Fry Basket Divider	Each	12/72

FRY BASKET PRESSES

- ◆ Heavy gauge wire handles with high-temperature resistant colored plastic coating
- ◆ Nickel plated

ITEM	DESCRIPTION	COLOR	UOM	CASE
FB-PS	Press Fits FB-10 & FB-20, 11" Handle	Red	Each	20
FB-PB	Press Fits FB-30, 11" Handle	Red	Each	20

FRY SCOOPS



FFBN-1R



FFBN-2

WINCO PRIME™ FRENCH FRY SCOOPS

- ◆ 18/8 stainless steel with 4" long plastic handles
- ◆ Removable handles for easy cleaning

ITEM	DESCRIPTION	UOM	CASE
FFBN-1R	Right Handle, NSF	Each	12/36
FFBN-2	Dual Handles, NSF	Each	12/36



NSF FFBN-SERIES

FRENCH FRY SCOOPS

- ◆ Stainless steel with 4" long plastic handles
- ◆ Removable handles for easy cleaning

ITEM	DESCRIPTION	UOM	CASE
FFB-1R	Right Handle	Each	12/36
FFB-2	Dual Handles	Each	12/36

FFB-1R



FFB-2



FRY OIL FILTER



FF-10 & FF-RC

FRYER OIL CONE FILTERS AND WIRE STAND

- ◆ Cloth filters are heat resistant up to 392°F (200°C)

ITEM	DESCRIPTION	UOM	CASE
FF-10	10" Filter Stand	Each	20
FF-RC	Filter Cones, Cloth, 10-Pcs/ Box	Box	1/60

18 GAUGE, 18/8 STAINLESS STEEL FRYER SPLASH GUARD **FRYER ACCESSORIES**

- ◆ 20-1/2"L x 18"H
- ◆ Clips fit most fryers with 1 inch wide walls
- ◆ Use on either left or right side of fryer to prevent oil splashes on walls, floors or other equipment
- ◆ Easily detaches for cleaning

ITEM	DESCRIPTION	UOM	CASE
SFSG-2018	20-1/2"L x 18"H	Each	1/6

18/8
Fits 1" Wall
Stainless Steel



Clips fit 1" wide walls

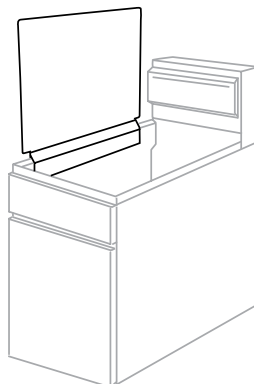

Use on either left or right of fryer



SFSG-2018

CHROME-PLATED FRYER SCREEN

- ◆ For use with: Imperial: IFS-40; DCS: FRFG-40; American Range: AF-45; PITCO: 35C and 45C

ITEM	DESCRIPTION	UOM	CASE
FS-1313	13" x 13"	Each	12/48

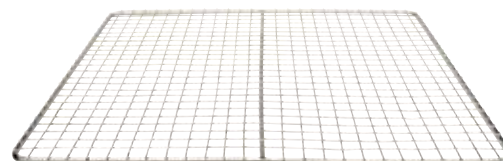

FS-1313

STAINLESS STEEL FRYER CLEANOUT ROD

- ◆ Clean out clogged fryer drains

ITEM	DESCRIPTION	UOM	CASE
SFCR-30	30"L	Each	24/144



SFCR-30

STAINLESS STEEL UNIVERSAL FRYER CONNECTOR STRIP

- ◆ Prevent debris falling between a bank of fryers

ITEM	DESCRIPTION	UOM	CASE
SFCS-21	21-5/8"L, for 3 or 4 Tube Fryers	Each	12/24
SFCS-25	25-5/8"L, for 5 Tube Fryers	Each	12/24

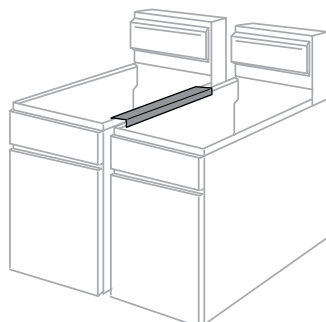

SFCS-21

SFCS-25

STAINLESS STEEL
STEAM TABLE PANS

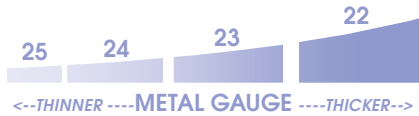

- ◆ Winco® offers the most complete collection of steam table pans in the industry
- ◆ Anti-jamming pans available in all gauges; straight sided pans available in standard weight
- ◆ Every gauge weight is made of 18/8 stainless steel

NSF STEAM TABLE PANS



SPJH-906GN

A WINCO®
EXCLUSIVE SIZE

Ninth x 6" deep

Adds 30% more
counter capacity



HEAVYWEIGHT

TRUE 24 GAUGE
ANTI-JAMMING

TRUE 23 GAUGE
ANTI-JAMMING

TRUE 22 GAUGE
ANTI-JAMMING

SIZE	DEPTH	UOM	CASE	ITEM	ITEM	ITEM
Full-Size 20-3/4" x 12-3/4"	1-1/4"	Each	6/12			SPJH-101
	2-1/2"	Each	6/12	SPJM-102	SPJP-102	SPJH-102
	4"	Each	6/12	SPJM-104	SPJP-104	SPJH-104
	6"	Each	6/12	SPJM-106	SPJP-106	SPJH-106
Half-Size 10-3/8" x 12-3/4"	1-1/4"	Each	12/24			SPJH-201
	2-1/2"	Each	12/24	SPJM-202	SPJP-202	SPJH-202
	4"	Each	6/24	SPJM-204	SPJP-204	SPJH-204
	6"	Each	6/12	SPJM-206	SPJP-206	SPJH-206
Third-Size 6-7/8" x 12-3/4"	2-1/2"	Each	12/48	SPJM-302	SPJP-302	SPJH-302
	4"	Each	12/24	SPJM-304	SPJP-304	SPJH-304
	6"	Each	12/24	SPJM-306	SPJP-306	SPJH-306
Quarter-Size 10-5/6" x 6-5/16"	2-1/2"	Each	12/72	SPJM-402	SPJP-402	SPJH-402
	4"	Each	12/48	SPJM-404	SPJP-404	SPJH-404
	6"	Each	12/24	SPJM-406	SPJP-406	SPJH-406
Sixth-Size 6-7/8" x 6-5/16"	2-1/2"	Each	12/72	SPJM-602	SPJP-602	SPJH-602
	4"	Each	12/48	SPJM-604	SPJP-604	SPJH-604
	6"	Each	12/48	SPJM-606	SPJP-606	SPJH-606
Ninth-Size 6-3/4" x 4-1/4"	2-1/2"	Each	12/72	SPJM-902	SPJP-902	SPJH-902
	4"	Each	12/72	SPJM-904	SPJP-904	SPJH-904
	6"	Each	12/24			SPJH-906GN
Eighteenth Size 4-1/4" x 3-1/2"	2"	Each	24/96			SPJH-1802

A WINCO®
EXCLUSIVE
SIZE



SPJH-1802

Eighteenth x 2" deep

STANDARD WEIGHT

25 GAUGE
STRAIGHT-SIDED

25 GAUGE
ANTI-JAMMING

SIZE	DEPTH	UOM	CASE	ITEM	ITEM
Full-Size 20-3/4" x 12-3/4"	1-1/4"	Each	6/12	SPF1	
	2-1/2"	Each	6/12	SPF2	SPJL-102
	4"	Each	6/12	SPF4	SPJL-104
	6"	Each	6/12	SPF6	SPJL-106
Two-Third Size 14" x 12-7/8"	2-1/2"	Each	12/24	SPTT2	
	4"	Each	6/24	SPTT4	
	6"	Each	6/12	SPTT6	
Half-Size 10-3/8" x 12-3/4"	1-1/4"	Each	12/24	SPH1	
	2-1/2"	Each	12/24	SPH2	SPJL-202
	4"	Each	6/24	SPH4	SPJL-204
	6"	Each	6/12	SPH6	SPJL-206
Third-Size 6-7/8" x 12-3/4"	2-1/2"	Each	12/48	SPT2	SPJL-302
	4"	Each	12/24	SPT4	SPJL-304
	6"	Each	12/24	SPT6	SPJL-306
Quarter-Size 10-5/6" x 6-5/16"	2-1/2"	Each	12/72	SPQ2	SPJL-402
	4"	Each	12/48	SPQ4	SPJL-404
	6"	Each	12/24	SPQ6	SPJL-406
Sixth-Size 6-7/8" x 6-5/16"	2-1/2"	Each	12/72	SPS2	SPJL-602
	4"	Each	12/48	SPS4	SPJL-604
	6"	Each	12/48	SPS6	SPJL-606
Ninth-Size 6-3/4" x 4-1/4"	2-1/2"	Each	12/72	SPN2	SPJL-902
	4"	Each	12/72	SPN4	SPJL-904



Anti-jamming



Straight-sided

GET-A-GRIP™ CHAFING DISH FOOD PAN

◆ Patented pan and handle system prevents steam burns

ITEM	DESCRIPTION	UOM	CASE
SPF2-HD	Full-Size w/Handles	Each	6



Patented handle system



SPF2-HD

22 GAUGE ANTI-JAMMING PERFORATED STEAM PANS

ITEM	DESCRIPTION	DEPTH	UOM	CASE
SPJH-102PF	Full-Size, Perf'd	2-1/2"	Each	6/12
SPJH-104PF	Full-Size, Perf'd	4"	Each	6/12
SPJH-106PF	Full-Size, Perf'd	6"	Each	6/12
SPJH-202PF	Half-Size, Perf'd	2-1/2"	Each	12/24
SPJH-204PF	Half-Size, Perf'd	4"	Each	6/24
SPJH-206PF	Half-Size, Perf'd	6"	Each	6/12



SPJH-104PF
Anti-jamming

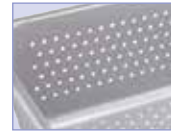

Ample holes allow drainage, also great for steaming



SPFP4

SPJH-SERIES
SPFP-SERIES

25 GAUGE PERFORATED STEAM PANS

ITEM	DESCRIPTION	DEPTH	UOM	CASE
SPFP2	Full-Size, Perf'd	2-1/2"	Each	6/12
SPFP4	Full-Size, Perf'd	4"	Each	6/12
SPFP6	Full-Size, Perf'd	6"	Each	6/12
SPHP2	Half-Size, Perf'd	2-1/2"	Each	6/24
SPHP4	Half-Size, Perf'd	4"	Each	6/24
SPHP6	Half-Size, Perf'd	6"	Each	6/12

22 GAUGE ANTI-JAMMING HALF LONG STEAM PANS

ITEM	DESCRIPTION	DEPTH	UOM	CASE
SPJH-2HL	Half Long Pan	2-1/2"	Each	6/24
SPJH-4HL	Half Long Pan	4"	Each	6/24
SPJH-6HL	Half Long Pan	6"	Each	6/12



SPJH-2HL
22 gauge

25 GAUGE ANTI-JAMMING HALF LONG STEAM PANS

ITEM	DESCRIPTION	DEPTH	UOM	CASE
SPJL-2HL	Half Long Pan	2-1/2"	Each	6/24
SPJL-4HL	Half Long Pan	4"	Each	6/24
SPJL-6HL	Half Long Pan	6"	Each	6/12



SPJL-6HL
25 gauge

SPJH-SERIES
SPJL-SERIES

STAINLESS STEEL DIVIDED FOOD PANS

ITEM	DESCRIPTION	DEPTH	UOM	CASE
SPFD2	Full-Size, Two Sections, NSF	2-1/2"	Each	6/12
SPFD-2R	15-1/4"Dia Round, Two Sections, Fits 103A, 103B, 602 and 308A Chafers	2-1/2"	Each	10



SPFD2

STAINLESS STEEL WATER PANS FOR CHAFERS

ITEM	DESCRIPTION	DEPTH	UOM	CASE
C-WPF	Full-Size Water Pan, Dripless Edge	4"	Each	6



Dripless Edge



C-WPF

STAINLESS STEEL SPILLAGE PANS FOR STEAM PANS

ITEM	DESCRIPTION	DEPTH	UOM	CASE
C-WPF6	Full-Size Spillage Pan, Upright Standing Edge, NSF	6"	Each	5/10
C-WPP	Full-Size Spillage Pan, Flat Edge, NSF	6"	Each	6/12



Upright Standing Edge



C-WPF6



Flat Edge



C-WPP

BUTTER ROLLER



SPBR-604



18/8 STAINLESS STEEL 1/6 SIZE BUTTER ROLLER

- ◆ Fits into 7"L x 6-3/8"W size opening
- ◆ Roller is removable for easy cleaning

ITEM	DESCRIPTION	UOM	CASE
SPBR-604	7"L x 6-3/8"W	Each	1/6

ROLL-TOP COVER



C-RCF

18/8 SATIN-FINISH STAINLESS STEEL ROLL-TOP COVER

- ◆ Fits full-size 12" x 20" food well opening
- ◆ Plastic handle is heat resistant up to 220°F (105°C)

ITEM	DESCRIPTION	UOM	CASE
C-RCF	20-3/4"L x 13"W x 11-7/8"H	Each	1/2



Open over a food pan



Closed over a food pan

Also fits standard size food warmers/cookers

STEAM PAN COVERS



SOLID COVERS



SPSCF



SLOTTED COVERS



SPCF



C-HFC1



C-HDC

18/8 STAINLESS STEEL FLAT COVERS

- ◆ Center handle for easy-lift open/close

ITEM	DESCRIPTION	UOM	CASE
SPSCF	1/1 Solid Cover	Each	12/24
SPSCH	1/2 Solid Cover	Each	12/48
SPSCT	1/3 Solid Cover	Each	12/72
SPSCQ	1/4 Solid Cover	Each	12/72
SPSCS	1/6 Solid Cover	Each	12/72
SPSCN	1/9 Solid Cover	Each	12/72
SPSCN-GN	1/9 Solid Cover for SPJH-906GN	Each	10/40
SPSCTT	2/3 Solid Cover	Each	12/24
SPCF	1/1 Slotted Cover	Each	12/24
SPCH	1/2 Slotted Cover	Each	12/48
SPCT	1/3 Slotted Cover	Each	12/72
SPCQ	1/4 Slotted Cover	Each	12/72
SPCS	1/6 Slotted Cover	Each	12/72
SPCN	1/9 Slotted Cover	Each	12/72
SPCN-GN	1/9 Slotted Cover for SPJH-906GN	Each	10/40
SPCTT	2/3 Slotted Cover	Each	12/24

STAINLESS STEEL HINGED COVERS WITH DUAL HANDLES

ITEM	DESCRIPTION	UOM	CASE
C-HFC1	Full-Size Hinged Flat Cover	Each	6/12
C-HDC	Full-Size Hinged Dome Cover	Each	12

STAINLESS STEEL DOME COVERS WITH CENTER HANDLE

ITEM	DESCRIPTION	UOM	CASE
C-DCF	Full-Size Dome Cover	Each	12
C-DCH	Half-Size Dome Cover	Each	24



C-DCF



C-DCH

STAINLESS STEEL HALF LONG COVERS

ITEM	DESCRIPTION	UOM	CASE
SPJL-HCN	Half Long Cover, Notched	Each	12/24
SPJL-HCS	Half Long Cover, Solid	Each	12/24



SPJL-HCN



SPJL-HCS



SPJL-SERIES



New Item

HINGED CLEAR POLYCARBONATE STEAM PAN COVERS

- ◆ Stain, break, chip-resistant for long-lasting use
- ◆ Slotted opening fits serving spoon or ladle
- ◆ Hinged design helps prevent cross-contamination

ITEM	DESCRIPTION	PAN SIZE	UOM	CASE
SP7200H	Hinged Lid	1/2 Size	Each	12/48
SP7300H	Hinged Lid	1/3 Size	Each	12/48
SP7600H	Hinged Lid	1/6 Size	Each	12/48



Also fits on poly food pans



Easy-lift tab, slot for spoon/ladle

HINGED PC STEAM PAN COVERS



STAINLESS STEEL STEAM PAN GRATES

- ◆ Feet elevate food off pan and allows for air circulation
- ◆ Also useful as a cooling or icing rack

ITEM	DESCRIPTION	STEAM PAN SIZE	UOM	CASE
PGWS-1018	For Full-Size	10" x 18"	Each	12/48
PGWS-810	For Half-Size	8" x 10"	Each	12/48
PGWS-510	For Third-Size	5" x 10-1/2"	Each	12/48

CHROME-PLATED STEAM PAN GRATES

ITEM	DESCRIPTION	STEAM PAN SIZE	UOM	CASE
PGW-1018	For Full-Size	10" x 18"	Each	12/48
PGW-810	For Half-Size	8" x 10"	Each	12/48
PGW-510	For Third-Size	5" x 10-1/2"	Each	12/48

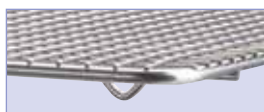

Raised Feet

STEAM PAN ACCESSORIES

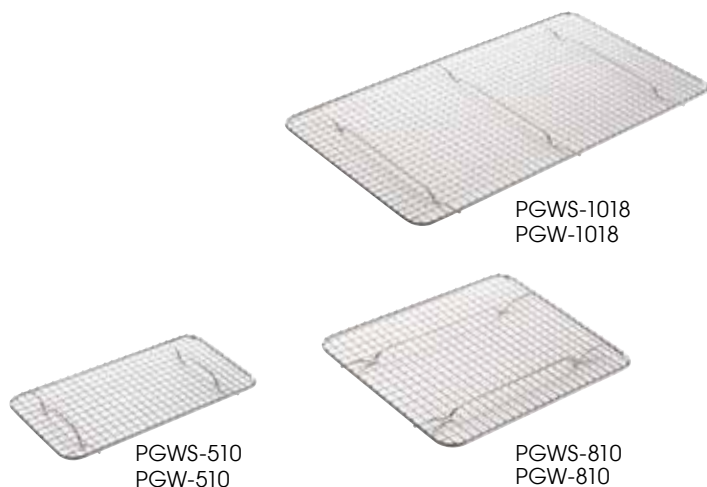

18/8 STAINLESS STEEL FALSE BOTTOMS

- ◆ Allow liquids to drain away from food in pan

ITEM	DESCRIPTION	UOM	CASE
SPFB-1	Full-Size	Each	10/20
SPFB-2	Half-Size	Each	10/40
SPFB-3	Third-Size	Each	12/48
SPFB-4	Quarter-Size	Each	12/48
SPFB-6	Sixth-Size	Each	12/72
SPFB-9	Ninth-Size	Each	12/72

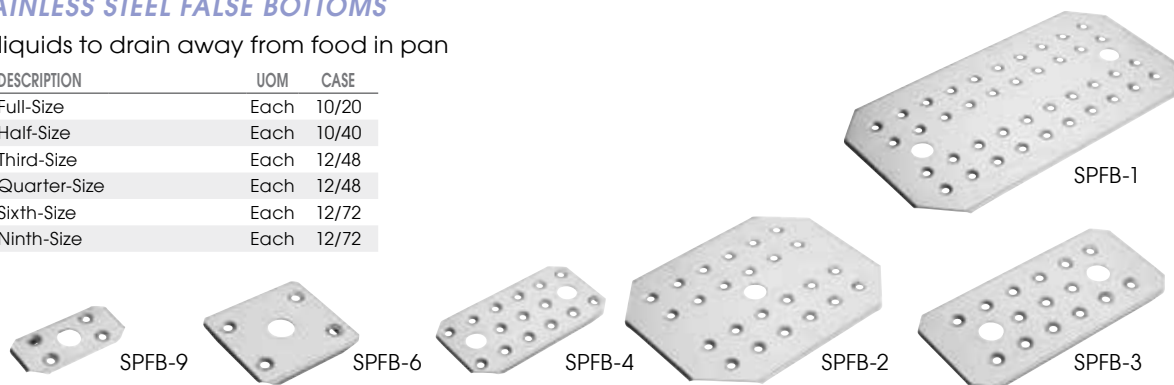

STAINLESS STEEL ADAPTOR BARS

- ◆ Use to divide steam table or food warmers for custom steam pan configurations

ITEM	DESCRIPTION	UOM	CASE
ADB-12	12"L x 1"W	Each	12/144
ADB-20	20"L x 1"W	Each	12/120

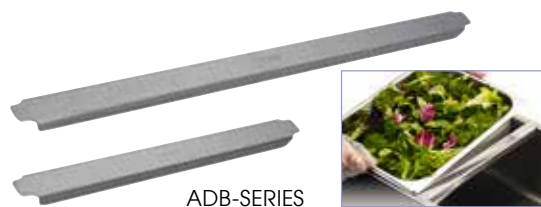

ADB-SERIES



STAINLESS STEEL ANGLED DISPLAY ADAPTOR

Lift steam table pans for an angled view and easy access to make a selection.

ITEM	DESCRIPTION	UOM	CASE
ADB-4	Full-Size	Each	2/6



ADB-4



Step up to Winco® Prime – A Cut Above

Winco Prime products are made with industry approved materials that comply with or exceed accepted industry standards. All products in the Winco Prime family are NSF® listed to give a comfort level that every effort has been made to provide a safe and durable product at an affordable price. Winco Prime products are safe to be used and will hold up well in the most demanding food service environment!

NSF® BAIN-MARIES

NSF® INSETS



BAMN-6



BAMN-6C



INSN-7



INSC-7M

WINCO® PRIME STAINLESS STEEL BAIN-MARIES

◆ Satin finish

ITEM	DESCRIPTION	SIZE	UOM	CASE
BAMN-1.25	1.25 Qt	5" x 6"	Each	6/48
BAMN-1.5	1.5 Qt	5-1/2" x 5-1/4"	Each	6/48
BAMN-2	2 Qt	5-3/4" x 7"	Each	6/48
BAMN-3.5	3.5 Qt	7-1/4" x 7"	Each	6/36
BAMN-4.25	4.25 Qt	7-1/4" x 7-3/4"	Each	6/36
BAMN-6	6 Qt	8" x 8-3/4"	Each	6/24
BAMN-8.25	8.25 Qt	9" x 9-3/4"	Each	6/24
BAMN-12	12 Qt	10" x 10-1/2"	Each	6/12

WINCO® PRIME STAINLESS STEEL INSET PANS

◆ Satin finish

ITEM	DESCRIPTION	SIZE	UOM	CASE
INSN-2.5	2.5 Qt	6" x 7-1/2"	Each	6/36
INSN-4	4 Qt	7-1/2" x 7-1/2"	Each	6/36
INSN-7	7 Qt	9-1/2" x 8"	Each	6/24
INSN-11	11 Qt	11-1/2" x 9"	Each	6/12

STAINLESS STEEL BAIN-MARIE COVERS

◆ Satin finish

ITEM	DESCRIPTION	UOM	CASE
BAMN-1.25C	Cover for BAMN-1.25	Each	12/144
BAMN-1.5C	Cover for BAMN-1.5	Each	12/144
BAMN-2C	Cover for BAMN-2	Each	12/144
BAMN-3.5C	Cover for BAMN-3.5	Each	12/144
BAMN-4.25C	Cover for BAMN-4.25	Each	12/72
BAMN-6C	Cover for BAMN-6	Each	12/72
BAMN-8.25C	Cover for BAMN-8.25	Each	12/48
BAMN-12C	Cover for BAMN-12	Each	12/24

STAINLESS STEEL INSET COVERS (NON-NSF)

◆ Mirror finish

ITEM	DESCRIPTION	UOM	CASE
INSC-2.5	Cover for INSN-2.5	Each	6/72
INSC-4	Cover for INSN-4	Each	6/36
INSC-7M	Cover for INSN-7	Each	6/48
INSC-11M	Cover for INSN-11	Each	6/36

STAINLESS STEEL BAIN-MARIES

◆ Bent rim for ease of handling and lifting

ITEM	DESCRIPTION	SIZE	UOM	CASE
BAM-1.25	1.25 Qt	5" x 6"	Each	6/48
BAM-1.5	1.5 Qt	5-1/2" x 5-1/4"	Each	6/48
BAM-2	2 Qt	5-3/4" x 7"	Each	6/48
BAM-3.5	3.5 Qt	7-1/4" x 7"	Each	6/36
BAM-4.25	4.25 Qt	7-1/4" x 7-3/4"	Each	6/36
BAM-6	6 Qt	8" x 8-3/4"	Each	6/24
BAM-8.25	8.25 Qt	9" x 9-3/4"	Each	6/24
BAM-12	12 Qt	10" x 10-1/2"	Each	3/6

MIRROR FINISH BAIN-MARIES & INSETS



BAM-6

STAINLESS STEEL BAIN-MARIE COVERS

◆ Center handle for lifting cover off/on

ITEM	DESCRIPTION	UOM	CASE
BAMC-1.25	For 1.25 Qt Bain Marie	Each	12/144
BAMC-2	For 2 Qt Bain Marie	Each	12/144
BAMC-3.5	For 3.5 Qt Bain Marie	Each	12/144
BAMC-4.25	For 4.25 Qt Bain Marie	Each	12/72
BAMC-6	For 6 Qt Bain Marie	Each	12/72
BAMC-8.25	For 8.25 Qt Bain Marie	Each	12/48
BAMC-12	For 12 Qt Bain Marie	Each	12/24



BAMC-SERIES

STAINLESS STEEL INSET PANS

ITEM	DESCRIPTION	SIZE	UOM	CASE
INS-2.5	2.5 Qt	6" x 7-1/2"	Each	6/36
INS-4.0	4 Qt	7-1/2" x 7-1/2"	Each	6/36
INS-7.0M	7 Qt, 24 gauge	9-1/2" x 8"	Each	6/24
INS-11.0M	11 Qt, 24 gauge	11-1/2" x 9"	Each	6/12



INS-7.0M

STAINLESS STEEL INSET COVERS

ITEM	DESCRIPTION	UOM	CASE
INSC-2.5	For 2.5 Qt Inset	Each	6/72
INSC-4	For 4 Qt Inset	Each	6/36
INSC-7M	For 7 Qt Inset	Each	6/48
INSC-11M	For 11 Qt Inset	Each	6/36



INSC-7M

STAINLESS STEEL HINGED COVERS

ITEM	DESCRIPTION	UOM	CASE
INSH-7	For 7 Qt Inset	Each	6/24
INSH-11	For 11 Qt Inset	Each	6/24



INSH-7

STAINLESS STEEL ADAPTOR PLATES

◆ 12" x 20" overall size

ITEM	DESCRIPTION	SIZE	UOM	CASE
ADP-608	6-3/8" and 8-3/8" Inset Holes	Fits 4 Qt and 7 Qt	Each	10
ADP-610	6-3/8" and 10-3/8" Inset Holes	Fits 4 Qt and 11 Qt	Each	10
ADP-666	Three 6-3/8" Inset Holes	Fits 4 Qt	Each	10
ADP-808	Two 8-3/8" Inset Holes	Fits 7 Qt	Each	10
ADP-810	8-3/8" and 10-3/8" Inset Holes	Fits 7 Qt and 11 Qt	Each	10
ADP-444	Adaptor Plate, Six 4-3/4" Inset Holes	Fits 2.5 Qt	Each	10

ADAPTOR PLATES

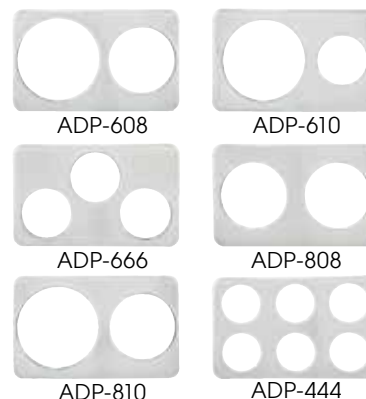

STAINLESS STEEL STEAM TABLE PAN/ FOOD PAN RACKS



SRK-36

Fits a combination of full, half or third-size pans



STAINLESS STEEL STEAM TABLE PAN/FOOD PAN RACKS

- ◆ Customize with a variety of steam table pans and food pans for the best configuration
- ◆ Dual-ended locking bars prevent pans from sliding out
- ◆ Caster bumpers protect walls, doors and rack during minor collisions
- ◆ Channel ledges are tightly welded to rails providing better support for pans
- ◆ 4" dia double-bearing, full-swivel casters help stabilize weight capacity
- ◆ Capacities: up to 1,000 Lbs (SRK-36) or up to 500 lbs (SRK-12, SRK-12D)
- ◆ Ships knocked down
- ◆ 1-1/2" and 1-3/4" spacing between each tier

36-TIER FULL HEIGHT RACKS

ITEM	DESCRIPTION	SIZE	UOM	CASE
SRK-36	36-Tier END-LOAD Rack	15-1/8" L x 21-5/8" W x 63-1/4" H	Each	1



Caster bumpers protect walls, doors and rack against minor collisions



Customize with a variety of steam table pans and food pans for the best configuration

12-TIER UNDER-COUNTER RACKS

ITEM	DESCRIPTION	SIZE	UOM	CASE
SRK-12	12-Tier END-LOAD Rack	15-1/8" L x 21-5/8" W x 31-1/2" H	Each	1
SRK-12D	12-Tier SIDE-LOAD Rack	23-1/4" L x 26" W x 31-1/2" H	Each	1

REPLACEMENT CASTERS

ITEM	DESCRIPTION	SIZE	UOM	CASE
SRK-CT	Caster for SRK-Series		Each	4/16
SRK-CTB	Caster w/Brake for SRK-Series		Each	4/16



SRK-12

Fits a combination of full, half or third-size pans



SRK-12D

Fits full-size pans only, two per tier



SRK-CT
4" castor



SRK-CTB
4" castor with brake

POLYCARBONATE FOOD PANS

PAN SIZING

SIZE	DIMENSIONS
Full-Size	20-3/4" x 12-1/2"
1/2-Size	12-3/4" x 10-3/8"
1/3-Size	12-5/8" x 6-7/8"
1/4-Size	10-1/4" x 6-1/4"
1/6-Size	6-3/4" x 6-1/4"
1/9-Size	6-7/8" x 4-1/4"

Withstands temps from -40°F to 210°F



Hinged lid with utensil slot

PC FOOD PANS 

PC COVERS 

FOOD PANS

ITEM	PAN SIZE	DEPTH	UOM	CASE
SP7102	Full-Size	2-1/2"	Each	6/12
SP7104		3-1/2"	Each	6/12
SP7106		5-1/2"	Each	6/12
SP7108		7-3/4"	Each	6/12
SP7202	1/2-Size	2-1/2"	Each	12/24
SP7204		3-1/2"	Each	6/24
SP7206		5-1/2"	Each	6/12
SP7208		7-3/4"	Each	6/12
SP7302	1/3-Size	2-1/2"	Each	12/24
SP7304		3-1/2"	Each	12/24
SP7306		5-1/2"	Each	6/24
SP7308		7-3/4"	Each	6/12
SP7402	1/4-Size	2-1/2"	Each	12/36
SP7404		3-1/2"	Each	12/36
SP7406		5-1/2"	Each	6/24
SP7602	1/6-Size	2-1/2"	Each	12/36
SP7604		3-1/2"	Each	12/48
SP7606		5-1/2"	Each	6/24
SP7902	1/9-Size	2-1/2"	Each	12/72
SP7904		3-1/2"	Each	12/72
SP7906		6"	Each	12/72

COVERS FOR FOOD PANS

ITEM	COVER STYLE	UOM	CASE
SP7100C	Slotted	Each	12/24
SP7100S	Solid	Each	12/24
SP7200C	Slotted	Each	12/48
SP7200S	Solid	Each	12/48
SP7200H	Hinged	Each	12/48
SP7300C	Slotted	Each	12/72
SP7300S	Solid	Each	12/72
SP7300H	Hinged	Each	12/48
SP7400C	Slotted	Each	12/72
SP7400S	Solid	Each	12/72
SP7600C	Slotted	Each	12/72
SP7600S	Solid	Each	12/72
SP7600H	Hinged	Each	12/48
SP7900C	Slotted	Each	12/72
SP7900S	Solid	Each	12/72

POLYCARBONATE DOME COVERS

- ◆ C-DP1, C-DPF1 and C-DPFH fit full-size steam table pans and poly pans
- ◆ C-DP2 and C-DPF2 fit half-size steam table pans and poly pans

ITEM	DESCRIPTION	SIZE	UOM	CASE
C-DP1	Full-Size Dome Cover	21-1/2" x 13-3/4"	Each	12
C-DP2	1/2-Size Dome Cover	13-1/2" x 11"	Each	24
C-DPF1	Full-Size Flip-Lid Cover	21-1/2" x 13-3/4"	Each	12
C-DPF2	1/2-Size Cut-Out Cover	13-1/2" x 11"	Each	24
C-DPFH	Full-Size Hinged Cover	21" x 13"	Each	12



C-DP1



C-DPFH



C-DPF2



C-DPF1

DOMES COVERS 

POLYCARBONATE DRAIN SHELVES

ITEM	DESCRIPTION	SIZE	UOM	CASE
SP71DS	Full-Size Drain Shelf	18" x 9-3/4"	Each	10/20
SP72DS	1/2-Size Drain Shelf	10" x 7-3/4"	Each	10/40
SP73DS	1/3-Size Drain Shelf	10-3/8" x 4-1/2"	Each	20/80
SP74DS	1/4-Size Drain Shelf	8-1/4" x 4-1/4"	Each	20/80
SP76DS	1/6-Size Drain Shelf	4-1/4" x 4-3/4"	Each	20/120
SP79DS	1/9-Size Drain Shelf	4-1/2" x 1-7/8"	Each	60/120



DRAIN SHELVES 

SQUARE FOOD STORAGE CONTAINERS & LIDS



NSF[®] PCSC-SERIES

PCSC-8C PCSC-4C

PCSC-18C



NSF[®]

BPA FREE PTSC-SERIES

PTSC-8

PTSC-4

PTSC-18



NSF[®]

BPA FREE

PESC-SERIES

PESC-8

PESC-4

PESC-18

- ◆ Clear polycarbonate is extremely durable, stackable, withstands temperatures from -40°F to 210°F, and is ideal for the storage and transport of raw or prepared food
- ◆ Polypropylene is stain resistant, withstands temperatures from -40°F to 160°F, and is ideal for the storage and transport of prepared food only
- ◆ Clear-view for quick inventory management, minimizing the need to open and expose contents
- ◆ Built-in handles; gradation marks in liters and quarts
- ◆ Dishwasher safe

CLEAR SQUARE POLYCARBONATE

ITEM	DESCRIPTION	UOM	CASE
PCSC-2C	2 Qt	Each	12/60
PCSC-4C	4 Qt	Each	12/48
PCSC-6C	6 Qt	Each	12/24
PCSC-8C	8 Qt	Each	12/24
PCSC-12C	12 Qt	Each	12
PCSC-18C	18 Qt	Each	12
PCSC-22C	22 Qt	Each	6

TRANSLUCENT SQUARE POLYPROPYLENE

ITEM	DESCRIPTION	UOM	CASE
PTSC-2	2 Qt	Each	12/60
PTSC-4	4 Qt	Each	12/48
PTSC-6	6 Qt	Each	12/24
PTSC-8	8 Qt	Each	12/24
PTSC-12	12 Qt	Each	12
PTSC-18	18 Qt	Each	12
PTSC-22	22 Qt	Each	6

WHITE SQUARE POLYPROPYLENE

ITEM	DESCRIPTION	UOM	CASE
PESC-2	2 Qt	Each	12/60
PESC-4	4 Qt	Each	12/48
PESC-6	6 Qt	Each	12/24
PESC-8	8 Qt	Each	12/24
PESC-12	12 Qt	Each	12
PESC-18	18 Qt	Each	12
PESC-22	22 Qt	Each	6



PECC-128P, PECC-68P, PECC-24P

Refer to Allergen-Free Utensils for purple handle collection



POLYETHYLENE SQUARE ALLERGEN-FREE COVERS

ITEM	DESCRIPTION	COLOR	UOM	CASE
PECC-24P	Fits 2 Qt & 4 Qt	Purple	Each	12
PECC-68P	Fits 6 Qt & 8 Qt	Purple	Each	12
PECC-128P	Fits 12 Qt, 18 Qt, 22 Qt	Purple	Each	6



PECC-24, PECC-68, PECC-128

POLYETHYLENE SQUARE COVERS

ITEM	DESCRIPTION	COLOR	UOM	CASE
PECC-24	Fits 2 Qt & 4 Qt	Green	Each	12
PECC-68	Fits 6 Qt & 8 Qt	Red	Each	12
PECC-128	Fits 12 Qt, 18 Qt, 22 Qt	Blue	Each	6
PECC-S	Fits 2 Qt & 4 Qt	White	Each	12
PECC-M	Fits 6 Qt & 8 Qt	White	Each	12
PECC-L	Fits 12 Qt, 18 Qt, 22 Qt	White	Each	6



PECC-S, PECC-M, PECC-L

NSF[®]

BPA FREE

LIDS

ROUND FOOD STORAGE CONTAINERS & LIDS

- ◆ Clear polycarbonate is extremely durable, stackable, withstands temperatures from -40°F to 210°F, and is ideal for the storage and transport of raw or prepared food
- ◆ Polypropylene is stain resistant, withstands temperatures from -40°F to 160°F, and is ideal for the storage and transport of prepared food only
- ◆ Clear-view for quick inventory management, minimizing the need to open and expose contents
- ◆ Built-in handles; gradation marks in liters and quarts
- ◆ Dishwasher safe

CLEAR ROUND POLYCARBONATE

ITEM	DESCRIPTION	UOM	CASE
PCRC-1	1 Qt	Each	48
PCRC-2	2 Qt	Each	24
PCRC-4	4 Qt	Each	12
PCRC-6	6 Qt	Each	12
PCRC-8	8 Qt	Each	12
PCRC-12	12 Qt	Each	12
PCRC-18	18 Qt	Each	6
PCRC-22	22 Qt	Each	6
PCRC-1C	Cover, Fits 1 Qt	Each	12
PCRC-24C	Cover, Fits 2 Qt and 4 Qt	Each	12
PCRC-68C	Cover, Fits 6 Qt and 8 Qt	Each	12
PCRC-1222C	Cover, Fits 12 Qt, 18 Qt, 22 Qt	Each	6



PCRC-6
PCRC-24C

PCRC-2

PCRC-8

PCRC-SERIES 

TRANSLUCENT ROUND POLYPROPYLENE

ITEM	DESCRIPTION	UOM	CASE
PTRC-1	1 Qt	Each	48
PTRC-2	2 Qt	Each	24
PTRC-4	4 Qt	Each	12
PTRC-6	6 Qt	Each	12
PTRC-8	8 Qt	Each	12
PTRC-12	12 Qt	Each	12
PTRC-18	18 Qt	Each	6
PTRC-22	22 Qt	Each	6
PTRC-1C	Cover, Fits 1 Qt	Each	12
PTRC-24C	Cover, Fits 2 Qt and 4 Qt	Each	12
PTRC-68C	Cover, Fits 6 Qt and 8 Qt	Each	12
PTRC-1222C	Cover, Fits 12 Qt, 18 Qt, 22 Qt	Each	6



PTRC-6
PTRC-24C

PTRC-2

PTRC-8

PTRC-SERIES  

WHITE ROUND POLYPROPYLENE

ITEM	DESCRIPTION	UOM	CASE
PPRC-1W	1 Qt	Each	48
PPRC-2W	2 Qt	Each	24
PPRC-4W	4 Qt	Each	12
PPRC-6W	6 Qt	Each	12
PPRC-8W	8 Qt	Each	12
PPRC-12W	12 Qt	Each	12
PPRC-18W	18 Qt	Each	6
PPRC-22W	22 Qt	Each	6
PPRC-1C	Cover, Fits 1 Qt	Each	12
PPRC-24C	Cover, Fits 2 Qt and 4 Qt	Each	12
PPRC-68C	Cover, Fits 6 Qt and 8 Qt	Each	12
PPRC-1222C	Cover, Fits 12 Qt, 18 Qt, 22 Qt	Each	6



PPRC-6W
PPRC-24C

PPRC-2W

PPRC-8W

PPRC-SERIES  

FOOD STORAGE BOXES & COLANDERS



PFSF-C

NSF PFSF & PFSH-SERIES

HEAVYWEIGHT CLEAR POLYCARBONATE FOOD BOXES

- ◆ Full-size measures 18" x 26"
- ◆ Half-size measures 12" x 18"
- ◆ Withstands temperatures from -40°F (-40°C) to 212°F (100°C)
- ◆ Clear-view for quick inventory management, minimizing the need to open and expose contents

ITEM	DESCRIPTION	CAPACITY	UOM	CASE
PFSF-3	Full-Size 3-1/2"	5 gal	Each	8
PFSF-6	Full-Size 6"	9 gal	Each	6
PFSF-9	Full-Size 9"	13 gal	Each	4
PFSF-12	Full-Size 12"	17 gal	Each	3
PFSF-15	Full-Size 15"	22 gal	Each	3
PFSF-C	Full-Size Cover for PFSF-Series		Each	12
PFSH-3	Half-Size 3-1/2"	1.75 gal	Each	12
PFSH-6	Half-Size 6"	3.5 gal	Each	6
PFSH-9	Half-Size 9"	5 gal	Each	6
PFSH-C	Half-Size Cover for PFSH-Series		Each	24



PFSF-5C

Perforations along bottom and all sides

Use with PFSF-6

NSF PFSF-SERIES COLANDERS

HEAVYWEIGHT CLEAR POLYCARBONATE FOOD BOX COLANDERS

- ◆ Stands up to hot, cold or frozen food items
- ◆ Withstands temperatures from -40°F (-40°C) to 212°F (100°C)

ITEM	DESCRIPTION	UOM	CASE
PFSF-5C	5" Deep, For PFSF-6	Each	6
PFSF-8C	8" Deep, For PFSF-9	Each	6



PFFW-C

NSF
BPA FREE
PFFW & PFHW-SERIES

WHITE POLYPROPYLENE FOOD BOXES

- ◆ Full-size measures 18" x 26"
- ◆ Half-size measures 12" x 18"
- ◆ Withstands temperatures from -40°F (-40°C) to 160°F (71°C)

ITEM	DESCRIPTION	CAPACITY	UOM	CASE
PFFW-3	Full-Size 3"	5 gal	Each	6
PFFW-6	Full-Size 6"	9 gal	Each	6
PFFW-9	Full-Size 9"	13 gal	Each	6
PFFW-12	Full-Size 12"	17 gal	Each	6
PFFW-15	Full-Size 15"	22 gal	Each	6
PFFW-C	Full-Size Cover for PFFW-Series		Each	6
PFHW-3	Half-Size 3"	1.75 gal	Each	12
PFHW-6	Half-Size 6"	3.5 gal	Each	12
PFHW-9	Half-Size 9"	5 gal	Each	12
PFHW-C	Half-Size Cover for PFHW-Series		Each	6

DRAIN SHELVES



PFSF-DS

NSF DRAIN SHELVES

CLEAR POLYCARBONATE DRAIN SHELVES

ITEM	DESCRIPTION	SIZE	UOM	CASE
PFSF-DS	Fits PFSF- & PFFW-Series Clear PC Food Boxes	13" x 21-1/8"	Each	12
PFSH-DS	Fits PFSH- & PFHW-Series White PP Food Boxes	8-1/4" x 14-1/4"	Each	24

POLYPROPYLENE DRY INGREDIENT MOBILE BINS

- ◆ Space-efficient under-counter height for bulk ingredients
- ◆ Advanced super-clasp, slanted lid design easily slides open to scoop ingredients; when closing, lid slides over the bin to reduce any debris on the lid from falling in
- ◆ Clear-view lid for quick inventory management, minimizing the need to open and expose contents
- ◆ Four 3" casters (2 fixed & 2 swivel w/brakes)
- ◆ Scoop (included) has a dedicated holding clip to ensure sanitation compliance

ITEM	DESCRIPTION	SIZE	UOM	CASE
IB-21	21 Gallon	13" x 29-1/4" x 28"	Set	1
IB-27	27 Gallon	15-1/2" x 29-1/2" x 28"	Set	1
IB-C3	Fixed Caster	3" Dia, Fits IB-21 & -27	Each	1
IB-C3B	Swivel Caster w/Brake	3" Dia, Fits IB-21 & -27	Each	1
IB-21-LE	Lid	Fits IB-21	Each	6
IB-27-LE	Lid	Fits IB-27	Each	6



IB-C3
Fixed caster



IB-C3B
Swivel caster with brake

ITEM #	WEIGHT SUGAR	WEIGHT FLOUR
IB-21	159 lbs	124 lbs
IB-27	197 lbs	154 lbs



Built-in storage holds scoop

DRY BULK INGREDIENT MOBILE BINS



IB-21



IB-27

IB-SERIES



POLYPROPYLENE DRY INGREDIENT SHELF BINS

- ◆ Stackable for more storage space
- ◆ One-handed lid lift design to increase efficiency
- ◆ Clear plastic front lid for quick ingredient identification
- ◆ Scoop (included) has a dedicated holding clip to ensure sanitation compliance

ITEM	DESCRIPTION	SIZE	UOM	CASE
IB-2S	2 Gallon, 40 Cup	11-3/4" x 14-1/4" x 8-3/8"	Each	1
IB-5S	5 Gallon, 80 Cup	11-1/8" x 23-3/8" x 16-7/8"	Each	1
IB-10S	10 Gallon, 150 Cup	19-1/4" x 23-3/8" x 16-7/8"	Each	1

DRY BULK INGREDIENT SHELF BINS



IB-10S



IB-5S



IB-2S

IB-SERIES



FOOD STORAGE CONTAINERS



FCW-10 & FCW-10RC



FCW-10L



FCW-10RC

NSF FCW-SERIES

BPA FREE CONTAINERS & SOLID LIDS

POLYETHYLENE FOOD STORAGE CONTAINERS

◆ Containers and lids sold separately

ITEM	DESCRIPTION	UOM	CASE
FCW-10	Container, 10 Gal	Each	1/6
FCW-20*	Container, 20 Gal	Each	1/6
FCW-10L	PP Lid for FCW-10	Each	1/24
FCW-20L	PP Lid for FCW-20	Each	1/12
FCW-10RC	PC Rotating Lid for FCW-10	Each	1/6

*Fits DLR-series dollies

ITEM #	CAPACITY (GALLONS)	CAPACITY (CUPS)	FLOUR (LBS)	SUGAR (LBS)
FCW-10	10	150	47	65
FCW-20	20	300	94	130

DELI CROCKS & COVERS



SAN-PLASTIC DELI CROCKS

ITEM	DESCRIPTION	COLOR	UOM	CASE
CRK-10R	10" x 7" x 3"	Red	Each	24
CRK-10K	10" x 7" x 3"	Black	Each	24
CRK-10C	10" x 7" x 3"	Clear	Each	24
CRK-10W	10" x 7" x 3"	White	Each	24
CRK-13R	13" x 10" x 3"	Red	Each	12
CRK-13K	13" x 10" x 3"	Black	Each	12
CRK-13C	13" x 10" x 3"	Clear	Each	12
CRK-13W	13" x 10" x 3"	White	Each	12



BPA FREE CRK-SERIES

COVERS FOR DELI CROCKS

ITEM	DESCRIPTION	COLOR	UOM	CASE
CRKC-10	Cover for CRK-10 Series	Clear	Each	48
CRKC-13	Cover for CRK-13 Series	Clear	Each	48



CRKC-13

CRKC-10

PLASTIC BEVERAGE CONTAINER & DISPENSER

- ◆ Hands-free, leak-proof faucet
- ◆ Secure snap-on lid
- ◆ Bail handle with comfortable handgrip for easy lifting
- ◆ Liter & quart gradation marks for identifying content level
- ◆ Withstands temps from -40°F (-40°C) to 160°F (71°C)
- ◆ Dishwasher safe

ITEM	DESCRIPTION	UOM	CASE
PBDW-22	6 Gallons, (22.7L) PP	Each	1/4
PBDW-HFFS	Hands-Free Faucet for PBDW-22	Each	1



PBDW-HFFS

BEVERAGE DISPENSER



Fill marks



Hands-free dispensing



PBDW-22

PBDW-SERIES



DOUGH BOXES & COVER

- ◆ Boxes stack tight to maintain freshness of contents
- ◆ Great for storing and proofing dough
- ◆ Reinforced structure resists breakage/bending over time
- ◆ Made of durable polypropylene

ITEM	DESCRIPTION	UOM	CASE
PL-3N	25-5/8"L x 18"W x 3-1/4"H	Each	6
PL-6N	25-1/2"L x 17-1/2"W x 6"H	Each	3
PL-36NC	Cover	Each	12



Stackable



Reinforced edges & corners

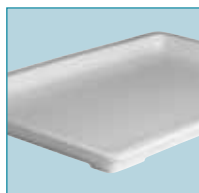

Lid can be used as tray



Seamless fit for fresh storage

DOUGH BOXES & DOLLY

PL-36NC

PL-3N

PL-6N



PL-SERIES



WIRE DOUGH BOX DOLLY

Transport multiple dough boxes with ease using this wire dolly, currently the only one on the market.

- ◆ Capacity up to 400 lbs
- ◆ Winco® exclusive
- ◆ 3-3/4" casters

ITEM	DESCRIPTION	UOM	CASE
DWR-2617	27"L x 18-1/4"W x 2-1/2"H	Each	1
DWR-CT	Caster for DWR-2617	Each	4/24
DWR-CTB	Caster w/ Brake for DWR-2617	Each	4/24



Transport dough boxes



DWR-2617



STAINLESS STEEL SHEET PANS

Dishwasher Safe

Safe, non-reactive solution for roasting and baking salty or acidic foods



SXP-1826

NSF SXP-SERIES



Open bead

18/8 STAINLESS STEEL SHEET PANS - OPEN BEAD

S/S sheet pans resist warping at high temperatures, retain heat longer, and are non-reactive, making them ideal for safely cooking salty or acidic foods.

◆ Open bead for easy, thorough clean

ITEM	DESCRIPTION	SIZE	GAUGE	UOM	CASE
SXP-1318	1/2-Size	13" x 18"	20	Each	6/12
SXP-1622	2/3-Size	16" x 22"	20	Each	6
SXP-1826	Full Size	18" x 26"	20	Each	6

Refer to Bussing & Transport for sheet pan racks



ALUMINUM SHEET PANS

Hand Wash



NSF ALXP-1200



Open bead

HEAVY-DUTY ALUMINUM SHEET PANS - OPEN BEAD

◆ Open bead for easy, thorough clean

ITEM	DESCRIPTION	SIZE	GAUGE	UOM	CASE
ALXP-0609	1/8-Size, NSF	6-1/2" x 9-1/2"	16	Each	24
ALXP-1204	1/4 Size, NSF	9-1/2" x 13"	16	Each	24
ALXP-1200	Full-Size, NSF	18" x 26"	12	Each	12



NSF ALXP-1204



NSF ALXP-0609



ALXP-2216H



Closed bead

ALUMINUM SHEET PANS - CLOSED BEAD

◆ Rust-resistant wire-in reinforced closed bead

ITEM	DESCRIPTION	SIZE	GAUGE	UOM	CASE
ALXP-1013	1/4-Size	9-1/2" x 13"	20	Each	24
ALXP-1310H	1/4-Size	10" x 13"	18	Each	24
ALXP-1318	1/2-Size	13" x 18"	20	Each	12
ALXP-1813H	1/2-Size	13" x 18"	18	Each	12
ALXP-1622	2/3-Size	16" x 22"	19	Each	12
ALXP-2216H	2/3-Size	16" x 22"	18	Each	12
ALXP-1826	Full-Size	18" x 26"	18	Each	12
ALXP-2618H	Full-Size	18" x 26"	16	Each	12



Glazed

ALXN-1826P

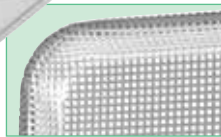

Full edge-to-edge perforation

FULLY PERFORATED NON-STICK ALUMINUM SHEET PANS - CLOSED-BEAD

- ◆ Edge-to-edge perforations for maximum air circulation
- ◆ Glazed non-stick coating
- ◆ Rust-resistant wire-in reinforced closed bead
- ◆ 3/32" (2.38mm) square perforations

ITEM	DESCRIPTION	SIZE	GAUGE	UOM	CASE
ALXN-1318P	1/2-Size	13" x 18"	16	Each	12
ALXN-1826P	Full-Size	18" x 26"	16	Each	12



ALXP-1318P



Perforated

PERFORATED ALUMINUM SHEET PANS - CLOSED-BEAD

- ◆ Dense 1/8" (3.18mm) diameter perforations maximize air circulation and heat conductivity
- ◆ Rust-resistant wire-in reinforced closed bead

ITEM	DESCRIPTION	SIZE	GAUGE	UOM	CASE
ALXP-1318P	1/2-Size	13" x 18"	18	Each	12
ALXP-1826P	Full-Size	18" x 26"	18	Each	12
ALXP-2618P	Full-Size	18" x 26"	16	Each	12

POLYPROPYLENE SHEET PAN COVERS

- ◆ Protect food products during transport and storage
- ◆ Snap-on, reusable alternative to film or foil
- ◆ Dishwasher safe

ITEM	DESCRIPTION	SIZE	UOM	CASE
CXP-1826	Full-Size	18" x 26"	Each	24
CXP-1318	Half-Size	13" x 18"	Each	24
CXP-1013	Quarter-size	10" x 13"	Each	24

SHEET PAN COVERS, EXTENDERS & GRATES



(sheet pan sold separately)



CXP-SERIES

NSF

BPA FREE

2" HIGH ALUMINUM SHEET PAN EXTENDERS

- ◆ Great for making sheet cakes without using a cake pan
- ◆ Flat top edges for easy gripping, and allows pans to stack while cooking or cooling
- ◆ Hand wash

ITEM	DESCRIPTION	SIZE	UOM	CASE
AXPE-1	Full-Size	18" x 26"	Each	12
AXPE-2	Half-Size	13" x 18"	Each	12
AXPE-4	Quarter-Size	9-1/2" x 13"	Each	12



Make sheet cakes without cake pan



AXPE-2

STAINLESS STEEL WIRE SHEET PAN GRATES

- ◆ Feet elevate food off pan and allows for air circulation
- ◆ Also useful as a cooling or icing rack

ITEM	DESCRIPTION	SHEET PAN SIZE	UOM	CASE
PGWS-2416	For Full-Size	16" x 24"	Each	12/24
PGWS-1216	For Half-Size	12" x 16-1/2"	Each	12/48



Raised Feet



PGWS-1216

CHROME-PLATED WIRE SHEET PAN GRATE

ITEM	DESCRIPTION	SHEET PAN SIZE	UOM	CASE
PGW-2416	For Full-Size	16" x 24"	Each	12/24
PGW-1420	For 2/3-Size	14" x 20"	Each	12/24
PGW-1216	For Half-Size	12" x 16-1/2"	Each	12/48



PGW-1420

- ◆ Reusable up to 2,000 times, use both sides
- ◆ Provides consistent & even heat distribution
- ◆ Woven fiberglass coated with food grade silicone
- ◆ Temperature tolerance from -40°F (-40°C) to 480°F (248°C)

SILICONE BAKING MATS

ALLERGEN-FREE PURPLE SILICONE BAKING MATS

ITEM	DESCRIPTION	SIZE	UOM	CASE
SBS-11PP	1/4-Size	8-1/4" x 11-3/4"	Each	20/100
SBS-16PP	1/2-Size	11-5/8" x 16-1/2"	Each	10/50
SBS-21PP	2/3-Size	14-7/16" x 20-1/2"	Each	10/50
SBS-24PP	Full-Size	16-3/8" x 24-1/2"	Each	10/50

Refer to Allergen-Free Utensils for purple handle collection



SBS-21PP

SILICONE BAKING MATS

ITEM	DESCRIPTION	SIZE	UOM	CASE
SBS-11	1/4-Size	8-1/4" x 11-3/4"	Each	20/100
SBS-16	1/2-Size	11-5/8" x 16-1/2"	Each	10/50
SBS-21	2/3-Size	14-7/16" x 20-1/2"	Each	10/50
SBS-24	Full-Size	16-3/8" x 24-1/2"	Each	10/50

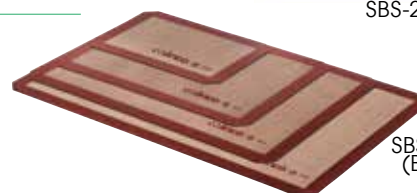

SBS-SERIES (BROWN)

NSF

PLASTIC SHEET TRAYS

- ◆ Can also be used as a sheet pan

ITEM	DESCRIPTION	COLOR	UOM	CASE
FFT-1826	Full-Size, 18" x 26"	White	Each	12
FFT-1826YL	Full-Size, 18" x 26"	Yellow	Each	6

PLASTIC SHEET TRAYS



FFT-1826

FFT-1826YL

FFT-SERIES

NSF



RECTANGULAR PANS



GLAZED ALUMINIZED STEEL PULLMAN PANS

- ◆ Non-stick coating, aluminized steel
- ◆ Durable, straight-sided folded construction
- ◆ Flat sliding lid holds in steam while baking for the perfect classic crust, great for slicing
- ◆ Hand wash only

ITEM	DESCRIPTION	SIZE	UOM	CASE
HPP-15	1-1/2 Lb	13" x 4" x 4"	Each	12
HPP-20	2 Lb	16" x 4" x 4"	Each	12
HPP-15L	Cover for HPP-15		Each	12
HPP-20L	Cover for HPP-20		Each	12



PFOA FREE

HSCP-0808



HRCP-1812

PFOA FREE

HRCP-SERIES



ALUMINIZED STEEL CAKE PANS

- ◆ Withstands temperatures to 500°F (260°C)
- ◆ 24 gauge non-stick aluminized steel
- ◆ Wire-in reinforced rim with folded body construction
- ◆ Dishwasher safe

ITEM	DESCRIPTION	SIZE	UOM	CASE
HRCP-1309	Rectangular	13" x 9" x 2-1/4"	Each	6
HRCP-1812	Rectangular	18" x 12" x 3"	Each	6
HSCP-0808	Square	8" x 8" x 2-1/4"	Each	6



ACP-0913

ACP-1212



HEAVYWEIGHT ALUMINUM CAKE PANS

- ◆ Straight sided, perfect for commercial baking
- ◆ Extended 1/2" flange for easy and safe handling
- ◆ 1.6mm thickness, 16 gauge
- ◆ Hand wash only

ITEM	DESCRIPTION	SIZE	UOM	CASE
ACP-0913	Rectangular	9" x 13" x 2"	Each	6
ACP-1212	Square	12" x 12" x 2"	Each	6



HLF-100



PFOA FREE

HLF-SERIES



ALUMINIZED STEEL LOAF PANS

- ◆ Withstands temperatures up to 500°F (260°C)
- ◆ 24 gauge non-stick aluminized steel
- ◆ Wire-in reinforced rim with folded body construction
- ◆ Dishwasher safe

ITEM	DESCRIPTION	SIZE	UOM	CASE
HLF-100	1 lb Loaf	8-1/2" x 4-1/2" x 2-3/4"	Each	6
HLF-150	1-1/2 lb Loaf	10" x 5" x 3"	Each	6

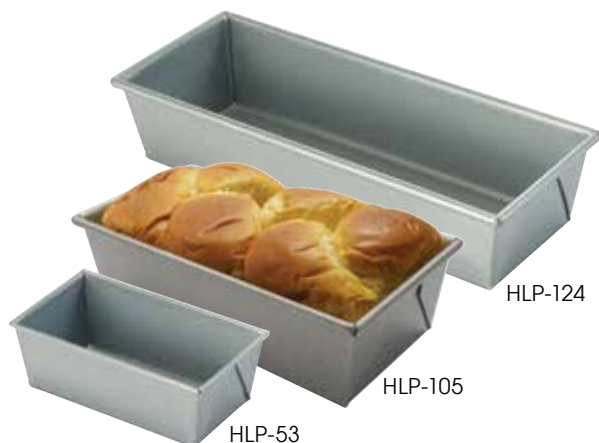

HLP-53

HLP-105

HLP-124

PFOA FREE

HLP-SERIES

ALUMINIZED STEEL LOAF PANS WITH SILICONE GLAZE

- ◆ Non-stick silicone coating
- ◆ Rolled top edge resists warping

ITEM	DESCRIPTION	SIZE	UOM	CASE
HLP-53	3/8 lb Loaf	5-5/8" x 3-1/8" x 2-1/4"	Each	24
HLP-84	1 lb Loaf	8-1/2" x 4-1/2" x 2-3/4"	Each	12
HLP-94	1 lb Loaf	9" x 4-1/2" x 2-3/4"	Each	12
HLP-105	1-1/2 lb Loaf	10" x 5" x 3"	Each	12
HLP-124	1-1/2 lb Loaf	12-1/4" x 4-1/2" x 2-3/4"	Each	12

GLAZED PERFORATED ALUMINUM BAGUETTE PANS

- ◆ 18" x 26" x 1"
- ◆ 16 gauge aluminum
- ◆ Non-stick silicone coating

ITEM	DESCRIPTION	UOM	CASE
ABPN-4	4 Slots	Each	6
ABPN-5	5 Slots	Each	6
ABPN-6	6 Slots	Each	6

Replaces ABP-Series



ABPN-6

BREAD PANS

Glazed



Perforations



ABPN-4

GLAZED ALUMINUM LONG ROLL PAN

- ◆ 13" x 18" x 1"
- ◆ 16 gauge aluminum
- ◆ Non-stick silicone coating

ITEM	DESCRIPTION	UOM	CASE
ABPN-5H	5 Slots, 13" x 18" x 1"	Each	6

Replaces ABP-5W

Glazed



ABPN-5H

SILICONE BREAD FORM

- ◆ Non-stick silicone surface requires no oils or sprays
- ◆ Heats quickly and bakes evenly
- ◆ Ideal size for 12" long sandwich bread
- ◆ Heat resistant up to 475°F (246°C)
- ◆ Dishwasher, oven, microwave and freezer safe

ITEM	DESCRIPTION	SIZE	UOM	CASE
SBF-5K	5 Roll	18" x 13"	Each	12/144



SBF-5K

STAINLESS STEEL SHEET-CAKE MARKERS

A must-have for consistent size square cuts.

- ◆ Full-size: 24-3/4"L x 16-3/4"W x 1"H

ITEM	DESCRIPTION	UOM	CASE
CKM-68	6 x 8, Marks (48) 3" x 3" Pieces	Each	24
CKM-69	6 x 9, Marks (56) 2-1/2" x 2-1/2" Pieces	Each	24
CKM-610	6 x 10, Marks (60) 2-1/4" x 2-1/2" Pieces	Each	24

SHEET CAKE MARKERS

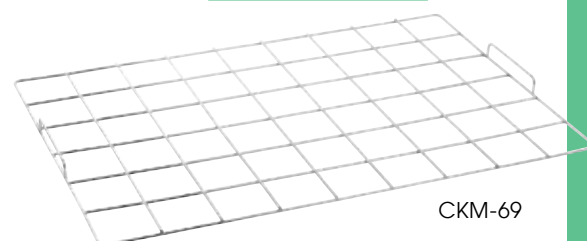

CKM-69

SPRINGFORM PANS



HSP-042

HSP-123



HSP-SERIES



ALUMINIZED STEEL SPRINGFORM PANS

- ◆ Quantum2® non-stick coating (double-coated)
- ◆ Withstands temperatures up to 500°F (260°C)
- ◆ 24 gauge
- ◆ Dishwasher safe

ITEM	DESCRIPTION	UOM	CASE
HSP-042	4"Dia x 1-1/2"H	Set	1/12
HSP-063	6"Dia x 2-3/4"H	Set	1/6
HSP-083	8"Dia x 2-3/4"H	Set	1/6
HSP-093	9"Dia x 2-3/4"H	Set	1/6
HSP-103	10"Dia x 2-3/4"H	Set	1/6
HSP-123	12"Dia x 2-3/4"H	Set	1/6



AASP-093



HARD ANODIZED ALUMINUM SPRINGFORM PANS

- ◆ Bakes evenly, releases cleanly
- ◆ Oven safe up to 450°F (232°C)
- ◆ Hand wash

ITEM	DESCRIPTION	UOM	CASE
AASP-063	6"Dia x 3"H	Each	1/36
AASP-093	9"Dia x 3"H	Each	1/24



CPSF-9

TIN SPRINGFORM PANS

- ◆ Withstands temperatures up to 482°F (250°C)

ITEM	DESCRIPTION	UOM	CASE
CPSF-8	8"Dia x 3"H	Each	12/36
CPSF-9	9-1/2"Dia x 3"H	Each	12/24
CPSF-10	10"Dia x 3"H	Each	12/24

SPECIALTY CAKE PANS



CCP-10F



FLUTED CAKE PAN

- ◆ Quantum2® non-stick aluminized carbon steel
- ◆ Dishwasher safe

ITEM	DESCRIPTION	UOM	CASE
CCP-10F	10"Dia x 3-1/4"H	Each	1/6



CCP-10A



NON-STICK CARBON STEEL ANGEL-FOOD CAKE PANS

- ◆ Dishwasher safe

ITEM	DESCRIPTION	UOM	CASE
CCP-10A	10"Dia x 5"H, Removable Bottom, Quantum2® Non-Stick, Aluminized Carbon Steel	Each	1/6
NACP-10	10"Dia x 4"H, Non-Stick Carbon Steel	Each	12/24



NACP-10



NTHM-8



NON-STICK CARBON STEEL TURK HEAD MOLD

ITEM	DESCRIPTION	UOM	CASE
NTHM-8	8-1/2"Dia x 4"H	Each	12/24

DELUXE HARD ANODIZED ALUMINUM CAKE PANS

◆ 1.0mm thickness, 18 gauge

ITEM	DESCRIPTION	UOM	CASE
HAC-042	4"Dia x 2"H	Each	6/24
HAC-062	6"Dia x 2"H	Each	6/24
HAC-082	8"Dia x 2"H	Each	6/24
HAC-102	10"Dia x 2"H	Each	6/24
HAC-122	12"Dia x 2"H	Each	6/24
HAC-142	14"Dia x 2"H	Each	6/24
HAC-162	16"Dia x 2"H	Each	6/12

ROUND CAKE PANS



HAC-062



HAC-042
HAC-SERIES



ALUMINUM LAYER-CAKE PANS

ITEM	DESCRIPTION	UOM	CASE
ACP-032	3"Dia x 2"H	Each	12/48
ACP-042	4"Dia x 2"H	Each	12/48
ACP-062	6"Dia x 2"H	Each	6/36
ACP-063	6"Dia x 3"H	Each	6/36
ACP-082	8"Dia x 2"H	Each	6/36
ACP-083	8"Dia x 3"H	Each	6/36
ACP-092	9"Dia x 2"H	Each	6/36
ACP-093	9"Dia x 3"H	Each	6/36
ACP-102	10"Dia x 2"H	Each	6/36
ACP-103	10"Dia x 3"H	Each	6/36
ACP-122	12"Dia x 2"H	Each	6/36
ACP-123	12"Dia x 3"H	Each	6/24



ACP-032



ACP-063



ACP-042

ALUMINUM PIE PLATES

ITEM	DESCRIPTION	UOM	CASE
APPL-8	8"Dia	Each	12/72
APPL-9	9"Dia	Each	12/72
APPL-10	10"Dia	Each	12/72
APPL-11	11"Dia	Each	12/72



APPL-11



APPL-8

ALUMINIZED CARBON STEEL QUICHE/TART PANS

◆ Removable bottom eliminates damaging the crust by allowing for easy extraction of delicate molds

◆ Dishwasher safe

ITEM	DESCRIPTION	UOM	CASE
FQP-4	4"Dia x 3/4"H, 2-Pcs/Set	Set	1/6
FQP-8	8"Dia x 1-1/2"H	Each	1/6
FQP-10	10"Dia x 1-1/4"H	Each	1/6
FQP-12	12"Dia x 1-3/8"H	Each	1/6



FQP-10



FQP-SERIES



CAST ALUMINUM PIE/CAKE MARKERS

ITEM	DESCRIPTION	UOM	CASE
APM-06	6-Cut	Each	12/48
APM-07	7-Cut	Each	12/48
APM-08	8-Cut	Each	12/48
APM-10	10-Cut	Each	12/48
APM-12	12-Cut	Each	12/48

STAINLESS STEEL PIE CUTTERS

ITEM	DESCRIPTION	UOM	CASE
SCU-6	6-Cut	Each	6/12
SCU-7	7-Cut	Each	6/12
SCU-8	8-Cut	Each	6/12

MARKERS & CUTTERS

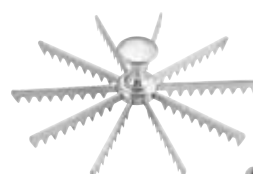

APM-10



SCU-6



PCM-1012

PCM-SERIES



DOUBLE-SIDED POLYPROPYLENE CAKE MARKERS

◆ Scores cakes up to 10" round for even slices

ITEM	DESCRIPTION	UOM	CASE
PCM-1012	10 & 12 Slice Marks	Each	12/24
PCM-1416	14 & 16 Slice Marks	Each	12/24

WIRE CAKE LEVELER

A must-have to make thin layered cakes and tortes.

◆ Adjustable stainless steel cutting wire with 10 notches

◆ Accommodates 10" diameter cakes that are 2" high

ITEM	DESCRIPTION	UOM	CASE
WLC-12	12" Bow	Each	24/144



WLC-12



MUFFIN PANS



HMF-20E
20 CUPS
LARGE 8.2OZ



HMF-24F
24 CUPS
TEXAS 5.6OZ



HMF-24S
24 CUPS
JUMBO 7OZ



HMF-35T
35 CUPS
CUPCAKE 3.8OZ



HMF-48O
48 CUPS
MINI 1.1OZ



HMF-48T
48 CUPS
MINI 2.1OZ



PFOA
FREE

HMF-SERIES

PTFE
FREE

GLAZED ALUMINIZED STEEL MUFFIN PANS

These non-stick muffin pans are designed for use in commercial ovens and on speed racks. The cups are properly spaced for achieving ideal muffin tops.

- ◆ Heavy-duty 26-gauge aluminized steel
- ◆ Premium non-stick coating for clean release
- ◆ Closed bead, wire-in reinforced rim
- ◆ All pans are 17-7/8" x 25-7/8", ideal for sheet pan racks

ITEM	DESCRIPTION	SIZE	CAPACITY	UOM	CASE
HMF-20E	20 Cups Large		8.2 Oz	Each	4
HMF-24F	24 Cups Texas		5.6 Oz	Each	4
HMF-24S	24 Cups Jumbo	All pans measure	7 Oz	Each	4
HMF-35T	35 Cups Cupcake	17-7/8" x 25-7/8"	3.8 Oz	Each	4
HMF-48O	48 Cups Mini		1.1 Oz	Each	4
HMF-48T	48 Cups Mini		2.1 Oz	Each	4



Refer to
Bussing &
Transport for
sheet pan racks



STANDARD 3 OUNCE CUP MUFFIN PANS

ITEM	DESCRIPTION	SIZE	CAPACITY	UOM	CASE
AMF-12	12 Cups, Alu	14" x 11"	3 Oz	Each	12/24
AMF-24	24 Cups, Alu	20-1/2" x 14"	3 Oz	Each	12
AMF-12NS	12 Cups, Non-stick Carbon Steel	15-1/2" x 11"	3 Oz	Each	24
AMF-24NS	24 Cups, Non-stick Heavy Alu	20-1/2" x 14"	3 Oz	Each	12



PFOA
FREE

AMF-24NS



PFOA
FREE

AMF-12NS



AMF-12

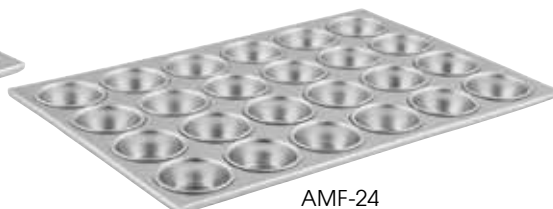

AMF-24

NON-STICK CARBON STEEL JUMBO MUFFIN PAN

- ◆ Makes 6 jumbo muffins or cupcakes

ITEM	DESCRIPTION	SIZE	CAPACITY	UOM	CASE
AMF-6NS	6 Cups	13" x 8-1/2"	7 Oz	Each	24



PFOA
FREE

AMF-6NS

New Item

NON-STICK CARBON STEEL MINI MUFFIN PANS

ITEM	DESCRIPTION	SIZE	CAPACITY	UOM	CASE
CMF-12M	12 Cups, Quantum2® Non-Stick	10" x 7-3/4"	3/4 Oz	Each	1/6
AMF-24MNS	24 Cups	13-3/4" x 10-1/2"	1-1/2 Oz	Each	12

MINI MUFFIN PANS

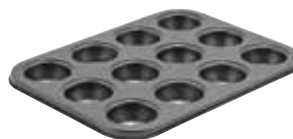

CMF-12M **PFOA FREE**



AMF-24MNS **PFOA FREE**

NON-STICK CARBON STEEL MINI LOAF PAN

Bake up 8 mini bread loaves. Also perfect for mini meat loaves, lasagnas, quiche, or pastries.

- ◆ Heavy-duty carbon steel with premium non-stick coating
- ◆ Makes 8 mini loaves
- ◆ Withstands temperatures up to 410°F (210°C)
- ◆ Dishwasher safe

ITEM	DESCRIPTION	SIZE	CAPACITY	UOM	CASE
HLF-8MN	8 Cups	14" x 10-5/8"	5 Oz	Each	6

MINI LOAF PAN



HLF-8MN **PFOA FREE**

DELUXE HARD-ANODIZED ALUMINUM COOKIE SHEET

- ◆ Excellent heat distribution for perfect cookies every time
- ◆ Non-stick for easy, quick release
- ◆ Withstands temperatures up to 450°F (232°C)
- ◆ Hand wash

ITEM	DESCRIPTION	SIZE	UOM	CASE
CS-2014	15 Gauge	20" x 14"	Each	4/16

COOKIE SHEET



CS-2014 **PFOA FREE**

ICING / COOLING WIRE RACK

- ◆ Built-in feet elevate the rack to allow air circulation

ITEM	DESCRIPTION	SIZE	UOM	CASE
ICR-1725	Rectangular	16-1/4" x 25"	Each	6/12



COOLING RACK

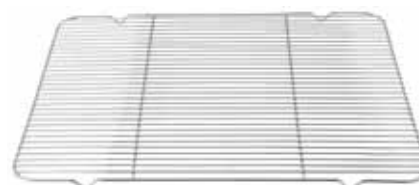

ICR-1725

NICKEL-PLATED WIRE DOUGHNUT BASKET

ITEM	DESCRIPTION	SIZE	UOM	CASE
DB-1218	Wire Basket	12" x 18" x 2"	Each	24

DOUGHNUT BASKET



DB-1218

CAKE DECORATING

Smooth rotation, one-motion stop



CKSR-12



NSF CKS-13C



CKS-13

NSF SDC-6



REVOLVING CAKE DECORATING STAND

- ◆ Aluminum alloy with precise ball-bearing for smooth rotation
- ◆ Sturdy cast iron base stands on a non-slip silicone bottom
- ◆ Shallow etched guides on plate for centering

ITEM	DESCRIPTION	UOM	CASE
CKSR-12	12"Dia	Each	6

CAKE STAND & COVER

- ◆ Stand: 13" diameter x 6" high
- ◆ Cover: 12" diameter x 7-1/2" high
- ◆ Cover available for full case purchase only

ITEM	DESCRIPTION	SIZE	UOM	CASE
CKS-13	Cake Stand, S/S	13" Dia	Set	6/12
CKS-13C	Cover for CKS-13, Plastic, NSF	12" Dia	Each	6



STAINLESS STEEL TRIANGLE DECORATING COMB

- ◆ 1.0mm thickness
- ◆ 3 different jagged teeth edges on each piece
- ◆ Each pack contains six (6) pieces

ITEM	DESCRIPTION	UOM	CASE
SDC-6	Fine, Medium, and Coarse	Pack	12/48

SPATULAS



TWPO-7



TWPS-7

NSF TWPO & TWPS-SERIES



WHITE ERGO HANDLE SPATULAS

- ◆ Stainless steel satin finish blade
- ◆ Dishwasher safe

ITEM	DESCRIPTION	BLADE	UOM	CASE
TWPO-4	Offset Spatula*	3-1/2" x 3/4"	Each	24/288
TWPO-7	Offset Spatula*	6-1/2" x 1-5/16"	Each	12/144
TWPO-9	Offset Spatula*	8-1/2" x 1-1/2"	Each	12/72
TWPS-4	Bakery Spatula	4" x 3/4"	Each	24/288
TWPS-7	Bakery Spatula	7-15/16" x 1-1/4"	Each	12/144
TWPS-9	Bakery Spatula	10" x 1-3/8"	Each	12/72

*Measurement reflects blade size not including offset



TKPO-7



TKPS-7

NSF TKPO & TKPS-SERIES



BLACK ERGO HANDLE SPATULAS

- ◆ Stainless steel satin finish blade
- ◆ Dishwasher safe

ITEM	DESCRIPTION	BLADE	UOM	CASE
TKPO-4	Offset Spatula*	3-1/2" x 3/4"	Each	24/288
TKPO-7	Offset Spatula*	6-1/2" x 1-5/16"	Each	12/144
TKPO-9	Offset Spatula*	8-1/2" x 1-1/2"	Each	12/144
TKPS-4	Bakery Spatula	4" x 3/4"	Each	24/288
TKPS-7	Bakery Spatula	7-15/16" x 1-1/4"	Each	12/144
TKPS-9	Bakery Spatula	10" x 1-3/8"	Each	12/144

*Measurement reflects blade size not including offset



TOS-7



TNS-7

WOODEN HANDLE SPATULAS

- ◆ Stainless steel satin finish blade

ITEM	DESCRIPTION	BLADE	UOM	CASE
TNS-4	Bakery Spatula	4" x 3/4"	Each	24/288
TNS-7	Bakery Spatula	7-15/16" x 1-1/4"	Each	12/144
TNS-9	Bakery Spatula	10" x 1-3/8"	Each	12/72
TOS-4	Spatula Offset	3-1/2" x 3/4"	Each	24/288
TOS-7	Spatula Offset	6-1/2" x 1-5/16"	Each	12/144
TOS-9	Spatula Offset	8-1/2" x 1-1/2"	Each	12/72

*Measurement reflects blade size not including offset

STAINLESS STEEL CAKE DECORATING TIP SETS

- ◆ Each set comes in a storage box
- ◆ CDT-26 & CDT-52 include standard coupler and metal flower nail

ITEM	DESCRIPTION	UOM	CASE
CDT-24	24-Pc Set	Set	60
CDT-26	26-Pc Set	Set	12/48
CDT-52	52-Pc Set	Set	6/24

DECORATING TIPS & PASTRY BAGS



CDT-26



CDT-24



CDT-26 & -52 storage box



CDT-52

CANVAS PASTRY BAGS

- ◆ Polyurethane plastic-coated interior

ITEM	DESCRIPTION	UOM	CASE
PBC-12	12"	Each	12/576
PBC-14	14"	Each	12/576
PBC-16	16"	Each	12/576
PBC-18	18"	Each	12/576
PBC-21	21"	Each	12/576
PBC-24	24"	Each	12/288



CDTC-2



PBC-16

PLASTIC COUPLINGS

ITEM	DESCRIPTION	UOM	CASE
CDTC-2	2-Pc Set	Set	12/360

HOBBY KNIFE & BLADES

- ◆ Detail cut/trim marzipan, fondant, gum paste
- ◆ Textured grip aluminum, #11 fine-point blade, & safety cap
- ◆ Wipe clean

ITEM	DESCRIPTION	UOM	CASE
KH-6	5-3/4"L, with 5 Bonus Blades	Each	12/144
KH-5R	Replacement Blades 5pcs/pk	Pack	100/1000

HOBBY KNIFE



KH-5R



KH-6



WHIPPED CREAM DISPENSER

- ◆ Includes 3 decorating tips to create unique dessert and beverage presentations, and a brush to clean them
- ◆ Capacity: 1 Pint (0.5L)
- ◆ Fits standard 8gm N2O cartridge (not included); compatible with all brands of whipped cream cartridges
- ◆ Durable aluminum bottle with stainless steel handle
- ◆ Hand-wash only

ITEM	DESCRIPTION	SIZE	UOM	CASE
CW-A05	Whipped Cream Dispenser with 3 Decorating Tips	3" Dia x 12"H	Each	1/12
CW-P	3 Tips With 1 Cleaning Brush		Set	1
CW-PG	Replacement Gasket, 3-Pcs/Pk		Pack	1

WHIPPED CREAM DISPENSER



Cartridge not included



CW-A05

3 DECORATING TIPS

BPA FREE

COOKIE & PASTRY CUTTERS

Create sweet, delicate confections with these cookie and pastry cutters. Made of rust-resistant stainless steel and available solid or fluted, in assorted shapes and sizes from 1" to 3" dia.



CST-1



STAINLESS STEEL COOKIE CUTTERS

ITEM	DESCRIPTION	SHAPE	UOM	CASE
CST-1	11-Pc Set, 1"H	Fluted Round	Set	12/48
CST-2	11-Pc Set, 1"H	Plain Round	Set	12/48
CST-12	11-Pc Set, 2"H	Fluted Round	Set	1/24
CST-22	11-Pc Set, 2"H	Plain Round	Set	1/24



CST-2



CST-12



CST-22



CST-31



STAINLESS STEEL PASTRY CUTTERS

ITEM	DESCRIPTION	SHAPE	UOM	CASE
CST-31	8-Pc Pastry Set	Butterflies	Set	12/60
CST-32	12-Pc Pastry Set	Shapes	Set	12/60
CST-33	6-Pc Pastry Set	Holiday	Set	12/60
CST-34	26-Pc Pastry Set	Letters	Set	12/48



CST-32



CST-33



CST-34



CC-1



CC-2

STAINLESS STEEL DEEP COOKIE CUTTER

- ◆ Ideal for cutting dough for biscuits
- ◆ 3" diameter x 2-1/2" deep cut

ITEM	DESCRIPTION	UOM	CASE
CC-1	Deep Cookie Cutter	Each	12/120

STAINLESS STEEL DOUGHNUT CUTTER

- ◆ 3" diameter x 2-1/2" deep cut

ITEM	DESCRIPTION	UOM	CASE
CC-2	Doughnut Cutter	Each	12/120



STAINLESS STEEL CULINARY PASTRY MOLDS

Perfect for baking, freezing, cutting and forming, these ring molds are extremely versatile kitchen tools. Create attractive plate presentations by layering salads and grains, or bake individual cake and pastry portions without waste.

- ◆ Polished smooth to a brilliant mirror finish
- ◆ Dishwasher safe

ITEM	DESCRIPTION	UOM	CASE
SPM-21R	Round, 2" Dia x 1-3/4"H	Each	12/72
SPM-23R	Round, 2" Dia x 3"H	Each	12/72
SPM-31R	Round, 3" Dia x 1-3/4"H	Each	12/72
SPM-31O	Oval, 3"L x 1-3/8"H	Each	12/72
SPM-41O	Oval, 4"L x 1-3/8"H	Each	12/72
SPM-22S	Square, 2"L x 2"W x 2"H	Each	12/72
SPM-275S	Square, 2-3/4"L x 2-3/4"W x 1-3/4"H	Each	12/72
SPM-211T	Rectangular, 2-1/2"L x 1-3/4"W x 1-3/4"H	Each	12/72



PASTRY MOLDS



SPM-23R



SPM-31R



SPM-21R



SPM-31O



SPM-41O



SPM-211T



SPM-275S



SPM-22S



DOUGH PREPARATION



ALDP-SERIES

ALUMINUM DOUGH RETARDING/PROOFING PANS & COVERS

◆ Stackable for easy storage

ITEM	DESCRIPTION	UOM	CASE
ALDP-48	48 Oz, 7-7/8"Dia x 3"H	Each	12/24
ALDP-48C	Cover for ALDP-48	Each	120
ALDP-96	96 Oz, 8-3/4"Dia x 3"H	Each	12/24
ALDP-96C	Cover for ALDP-96	Each	120

DOUGH BOXES & COVER



PL-36NC

PL-3N

PL-6N

PL-SERIES



BPA FREE

POLYPROPYLENE DOUGH BOXES & COVER

◆ Boxes stack tight to maintain freshness of contents

◆ Reinforced structure resists breakage/bending over time

ITEM	DESCRIPTION	UOM	CASE
PL-3N	25-5/8"L x 18"W x 3-1/4"H	Each	6
PL-6N	25-1/2"L x 17-1/2"W x 6"H	Each	3
PL-36NC	Cover	Each	12



Stackable



Reinforced edges & corners

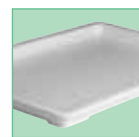

Lid can be used as tray



Seamless fit for fresh storage

DOUGH SCRAPERS

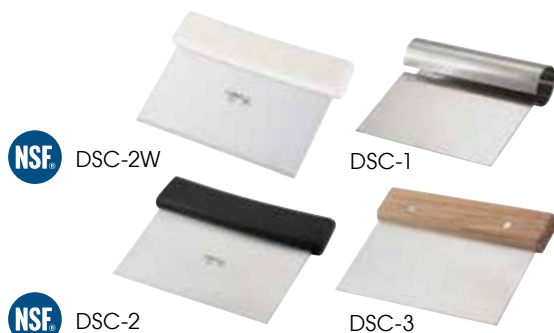

DSC-2W

DSC-1



DSC-2

DSC-3

DOUGH SCRAPERS

◆ Stainless steel blade

ITEM	DESCRIPTION	BLADE	UOM	CASE
DSC-1	Steel Handle	5-1/4" x 4-1/4"	Each	12/48
DSC-2	Plastic Handle, NSF	6" x 3"	Each	12/72
DSC-2W	Plastic Handle, NSF	6" x 3"	Each	12/72
DSC-3	Wooden Handle	6" x 3"	Each	12/72



Refer to Allergen-Free Utensils for purple handle collection



PDS-7P

DSC-2P

ALLERGEN-FREE DOUGH SCRAPERS

Whether it's gluten, nuts or more, use this stand-out purple color to designate these dough scrapers as allergen-free.

ITEM	DESCRIPTION	SIZE	UOM	CASE
DSC-2P	Dough Scraper, S/S Blade	6" x 3"	Each	12/72
PDS-7P	Plastic Dough Scrapers, 6-Pcs/Pk	7-1/2" x 4-3/4"	Pack	24/48



CR-899

BAR MAID® WHITE PLASTIC BOWL SCRAPER

ITEM	DESCRIPTION	SIZE	UOM	CASE
CR-899	Small, 250-Pcs/Pk	5-1/2" x 3-3/4"	Case	1

WHITE PLASTIC DOUGH SCRAPERS

ITEM	DESCRIPTION	SIZE	UOM	CASE
PDS-7	Large, 6-Pcs/Pk	7-1/2" x 4-3/4"	Pack	24/48
PDS-5	Small, 12-Pcs/Pk	5-1/2" x 3-3/4"	Doz	21/42



PDS-7



PDS-5

ADJUSTABLE DOUGH DIVIDERS

- ◆ Stainless steel wheels adjust width from 3/4" to about 4-3/8" apart for ADD-5 & to about 4-3/4" for ADD-6

ITEM	DESCRIPTION	UOM	CASE
ADD-5	5-Wheel	Each	36
ADD-6	6-Wheel	Each	36

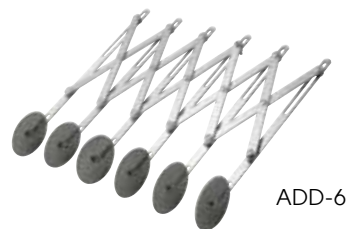
DOUGH WHEELS/DOCKERS

ADD-6

DOUGH ROLLER DOCKERS

- ◆ Stainless steel handle
- ◆ 8" Overall Length

ITEM	DESCRIPTION	UOM	CASE
RD-2	2-5/8"W Head	Each	1/24
RD-5	5"W Head	Each	1/24
RD-8	5"W Head, 8-Wheel	Each	1/24

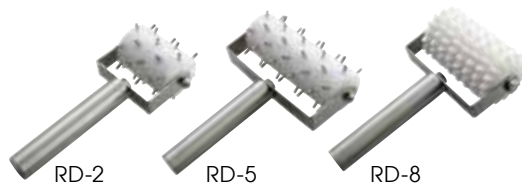

RD-2

RD-5

RD-8

PLASTIC ROLLER DOCKERS

- ◆ Prevent dough bubbles from forming
- ◆ RD-4P features 6 wheels spin independently

ITEM	DESCRIPTION	UOM	CASE
RD-4P	4"W Head, 6 Wheels, Molded Ergonomic Handle	Each	1/24
RD-5P	5"W Head, Plastic Handle	Each	12/72



RD-4P

RD-5P

ALUMINUM ROLLING PINS

- ◆ 3-1/2" diameter; Hand wash only, do not submerge

ITEM	DESCRIPTION	UOM	CASE
ARP-13	13"L x 3-1/2"Dia	Each	1/6
ARP-15	15"L x 3-1/2"Dia	Each	1/6
ARP-18	18"L x 3-1/2"Dia	Each	1/6

ROLLING PINS

ARP-15

WOODEN ROLLING PINS

- ◆ 2-3/4" diameter; Hand wash only, do not submerge

ITEM	DESCRIPTION	UOM	CASE
WRP-13	13"L x 2-3/4" Dia	Each	12
WRP-15	15"L x 2-3/4" Dia	Each	12
WRP-18	18"L x 2-3/4" Dia	Each	12



WRP-18

FRENCH WOODEN ROLLING PIN

- ◆ 1-3/16" diameter; Hand wash only, do not submerge

ITEM	DESCRIPTION	UOM	CASE
WRP-20F	20"L x 1-3/16"Dia, Tapered	Each	12/48



WRP-20F

**DOUBLE PASTRY WHEEL**

- ◆ Features 2 separate stainless steel blades, straight & fluted
- ◆ Ideal for ravioli, strudel, pastry dough
- ◆ Sturdy stainless steel blades with ergonomic plastic handle
- ◆ Safety guard for hand protection
- ◆ Hole in handle for convenient hanging
- ◆ Dishwasher safe

ITEM	DESCRIPTION	UOM	CASE
PPC-1D	Double Pastry Wheel	Each	12/144

PASTRY TOOLS

PPC-1D

ECONOMY PASTRY BLENDER

ITEM	DESCRIPTION	UOM	CASE
PST-5B	5 Blades, S/S	Each	12/72



PST-5B



BATTER DISPENSERS



APCD-6



88oz capacity
8 portion settings
from 1oz to 3oz



APCD-6R

ALUMINUM PANCAKE BATTER DISPENSER

- ◆ Dispense a consistent amount of batter
- ◆ 88oz (11 cups) overall capacity
- ◆ 8 portion-control settings range from 1oz to 3oz
- ◆ 10-gauge high-grade aluminum body
- ◆ Long lasting parts prevent clogging and leaking

ITEM	DESCRIPTION	UOM	CASE
APCD-6	Pancake Dispenser, Alu	Each	1/6
APCD-6R	Rack for APCD-6	Each	12/48



APCD-6 & APCD-6R



SF-7



SF-7 & SF-7R



SF-7R

CONFECTIONERY FUNNEL

- ◆ Use to dispense a smooth flow of fondant, syrup, or prepared creams
- ◆ Spring valve feature allows for easy control with single-handed operation
- ◆ Comes with 3 nozzles: 4mm, 5mm, 6mm
- ◆ Rack sold separately

ITEM	DESCRIPTION	UOM	CASE
SF-7	Funnel, S/S	Each	1/8
SF-7R	Rack for SF-7, S/S	Each	1/24

SIFTERS

RFS-8



STAINLESS STEEL ROTARY SIFTER

- ◆ 8 cup capacity

ITEM	DESCRIPTION	UOM	CASE
RFS-8	8 Cup Rotary Sifter	Each	1/12



SIV-14

STAINLESS STEEL SIEVES

- ◆ #20 mesh

ITEM	DESCRIPTION (DIA X H)	UOM	CASE
SIV-10	10" x 3"	Each	1/6
SIV-12	12" x 3"	Each	1/6
SIV-14	14" x 3"	Each	1/6
SIV-16	16" x 3"	Each	1/6

FUNNELS



SF-6



SF-6S

WIDE-MOUTH FUNNELS & REMOVABLE STRAINERS

- ◆ Stainless steel, mirror finish

ITEM	DESCRIPTION	UOM	CASE
SF-5	5" Funnel	Each	12/72
SF-6	5-3/4" Funnel	Each	12/72
SF-6S	Strainer for SF-5 and SF-6	Each	120/480



PF-32

PLASTIC FUNNELS

ITEM	DESCRIPTION	UOM	CASE
PF-8	8 Oz, 4"Dia	Each	6/324
PF-16	16 Oz, 5-1/4"Dia	Each	6/324
PF-32	32 Oz 6-1/4"Dia	Each	6/216

STAINLESS STEEL 3" ROUND STRAINER/SIFTER

- ◆ Craft a light sprinkle of powdered sugar, cocoa, nutmeg

ITEM	DESCRIPTION	UOM	CASE
MS2K-3S	8"L x 1"H O.L., 3"Dia Bowl	Each	24/144

STRAINER/SIFTER



MS2K-3S



STAINLESS STEEL POWDERED SUGAR DISPENSER

- ◆ Also ideal for cocoa, nutmeg or cinnamon
- ◆ Includes plastic cap

ITEM	DESCRIPTION	UOM	CASE
SSD-10	10 Oz	Each	12/60

DREDGES



Includes plastic cap



SSD-10

ADJUSTABLE 18/8 STAINLESS STEEL SHAKER DREDGE

- ◆ Mirror finish
- ◆ Features a three-way adjustable top with small, medium and large holes

ITEM	DESCRIPTION	UOM	CASE
DRG-8P	8 Oz	Each	12/96



DRG-8P



DRG-8P adjustable top

STAINLESS STEEL DREDGES

ITEM	DESCRIPTION	UOM	CASE
DRG-10	10 Oz w/Handle	Each	12/144
DRG-10H	10 Oz w/o Handle	Each	12/144
DRG-22H	22 Oz w/o Handle	Each	12/48



DRG-10



DRG-10H



DRG-22H

ALUMINUM DREDGES

ITEM	DESCRIPTION	UOM	CASE
ADRG-10	10 Oz w/ Handle	Each	12/144
ADRG-10H	10 Oz w/o Handle	Each	12/144



ADRG-10



ADRG-10H

CLEAR PLASTIC DREDGE SETS

- ◆ 10oz capacity with snap-on lids

ITEM	DESCRIPTION	UOM	CASE
PDG-10	10 Oz w/3 Clear Lids (S, M, L)	Set	1/48
PDG-10AC	10 Oz w/4 Colored Lids	Set	1/48
PDG-10CS	10 Oz w/Clear S Lid	Set	12/48
PDG-10CM	10 Oz w/Clear M Lid	Set	12/48
PDG-10CL	10 Oz w/Clear L Lid	Set	12/48
PDG-10CXL	10 Oz w/Clear XL Lid	Set	12/48
PDG-10B	10 Oz w/Beige Lid	Set	12/48
PDG-10G	10 Oz w/Green Lid	Set	12/48
PDG-10R	10 Oz w/Rose Lid	Set	12/48
PDG-10Y	10 Oz w/Yellow Lid	Set	12/48



PDG-10AC



PDG-10

PDG-SERIES 

COLORED PLASTIC DREDGE LIDS

- ◆ Fits both PDG-10 and PDG-10AC dredges

ITEM	DESCRIPTION	UOM	CASE
PDG-BL	Beige Lids, 6-Pcs/Pk	Pack	72/144
PDG-GL	Green Lids, 6-Pcs/Pk	Pack	72/144
PDG-RL	Rose Lids, 6-Pcs/Pk	Pack	72/144
PDG-YL	Yellow Lids, 6-Pcs/Pk	Pack	72/144



PDG-SERIES COLORED LIDS

PASTRY BRUSHES

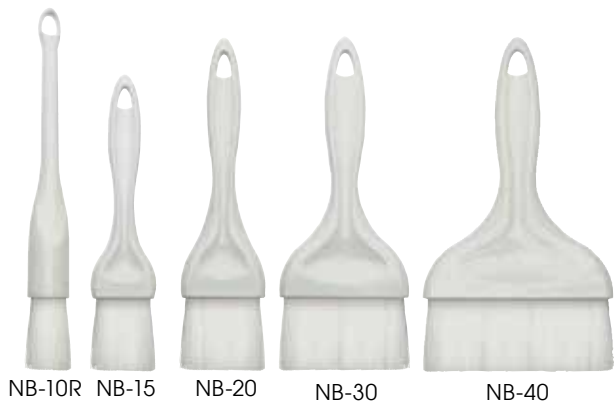

NB-10R NB-15 NB-20 NB-30 NB-40



Brushes with hook can stay on side of prep containers in between applications



NB-20HK



NB-30HK



WBRP-20H



WBRP-30H

NYLON BRISTLE PASTRY BRUSHES

Made for long lasting use, nylon bristle pastry brushes are versatile enough to use for basting meats or glazing pastries. Available in a variety of sizes to suit every need.

- ◆ Bristles are epoxy-set to ferrules which prevent bacteria from collecting
- ◆ Bristles are heat-resistant up to 300°F (150°C)
- ◆ Easy clean one-piece smooth-finish plastic handle
- ◆ Dishwasher safe

ITEM	DESCRIPTION	SIZE	UOM	CASE
NB-10R	Round Brush	1" Dia	Each	12/240
NB-15	Flat Brush	1-1/2"	Each	12/240
NB-20	Flat Brush	2"	Each	12/240
NB-20HK	Concave w/Hook	2"	Each	12/120
NB-30	Flat Brush	3"	Each	12/120
NB-30HK	Concave w/Hook	3"	Each	12/72
NB-40	Flat Brush	4"	Each	12/72

BOAR BRISTLE PASTRY BRUSHES

Made for heavy or thick sauces, boar bristle pastry brushes are ideal for basting meat and poultry.

- ◆ Bristles are heat-resistant up to 500°F (260°C)
- ◆ Concave head lifts bristles off counter surface
- ◆ Hook allows brushes to rest on the edge of prep containers

ITEM	DESCRIPTION	SIZE	UOM	CASE
WBRP-20H	Concave w/Hook	2"	Each	12/72
WBRP-30H	Concave w/Hook	3"	Each	12/72



WFB-SERIES



WBR-SERIES

PASTRY/BASTING BRUSHES

- ◆ Natural boar hair bristles
- ◆ WFB: wooden handle with plastic ferrules
- ◆ WBR: wooden handle with metal ferrules

ITEM	DESCRIPTION	SIZE	UOM	CASE
WFB-10	Flat Brush	1"	Each	12/144
WFB-10R	Round Brush	1" Dia	Each	12/144
WFB-15	Flat Brush	1-1/2"	Each	12/144
WFB-20	Flat Brush	2"	Each	12/144
WFB-30	Flat Brush	3"	Each	12/72
WFB-40	Flat Brush	4"	Each	12/72
WBR-10	Flat Pastry Brush	1"	Each	12/600
WBR-15	Flat Pastry Brush	1-1/2"	Each	12/600
WBR-20	Flat Pastry Brush	2"	Each	12/240
WBR-25	Flat Pastry Brush	2-1/2"	Each	12/240
WBR-30	Flat Pastry Brush	3"	Each	12/240
WBR-40	Flat Pastry Brush	4"	Each	12/240

PLASTIC BASTER

- ◆ 1.5 oz capacity with rubber bulb

ITEM	DESCRIPTION	UOM	CASE
PBST-1.5	7-1/2" Tube, 11" O.L.	Each	12/72

BPA FREE

PBST-1.5



OM-13

OIL MOP

ITEM	DESCRIPTION	UOM	CASE
OM-13	13" O.L., Cotton	Each	12/96

SILICONE BRUSH

The perfect tool for brushing on marinades, oil or butter onto meats, fish or breads. This silicone brush won't scratch foods and is non-stick friendly.

- ◆ 100% silicone exterior, stainless steel interior
- ◆ Heat-resistant up to 428°F (220°C)
- ◆ Dishwasher safe

ITEM	DESCRIPTION	UOM	CASE
SB-175R	1-3/4" W	Each	24/144

SILICONE BRUSH



SB-175R

BPA FREE

NEOPRENE NON-SLIP OVEN MITTS

- ◆ 100% neoprene shell, 100% cotton fill and lining
- ◆ Heat resistant up to 500°F (260°C)
- ◆ Stain and water resistant
- ◆ Hand wash, wipe clean

ITEM	DESCRIPTION	UOM	CASE
OMNP-15	15"	Each	12/48
OMNP-17	17"	Each	12/48

OVEN MITTS & POT HOLDERS



OMNP-SERIES

FLAME RETARDANT OVEN MITTS

- ◆ Offers protection up to 400°F (205°C)
- ◆ OMF-24 is extra-long for full arm-length protection
- ◆ 100% cotton
- ◆ Spot clean only

ITEM	DESCRIPTION	UOM	CASE
OMF-13	13"	Each	12/72
OMF-15	15"	Each	12/72
OMF-17	17"	Each	12/72
OMF-24	24"	Each	12/72



OMF-SERIES

SILICONE COATED OVEN MITTS

- ◆ Offers protection in (cold) freezer or (hot) oven
- ◆ Temperature range of 0°F (17°C) up to 200°F (93°C)
- ◆ 100% cotton with non-stick silicone outer coating
- ◆ Spot clean only

ITEM	DESCRIPTION	UOM	CASE
OMS-13	13"	Each	12/72
OMS-15	15"	Each	12/72
OMS-17	17"	Each	12/72



OMS-SERIES

TERRY CLOTH OVEN MITTS

- ◆ Withstands intermittent temperatures up to 600°F (315°C)
- ◆ 100% cotton, silicone lining, and sewn-in hanging loop
- ◆ Machine washable

ITEM	DESCRIPTION	UOM	CASE
OMT-13	13"	Each	12/72
OMT-17	17"	Each	12/72



OMT-SERIES

POT HOLDERS

ITEM	DESCRIPTION	SIZE	UOM	CASE
PH-8B	Green Side Fire Retardant, Other Side Terrycloth	8" x 8"	Doz	1/25
PH-8N	Black Neoprene, Stain & Water Resistant	8" x 8"	Each	12/72
PH-8S	Gray Cotton	8" x 8"	Doz	1/25
PH-9W	White Terrycloth w/ Pocket	8-1/2" x 9-1/2"	Doz	1/15

Heat-resistant up to 500°F for 15 seconds



PH-8N



PH-9W



PH-8S



PH-8B



SCRAPERS

Non-stick friendly

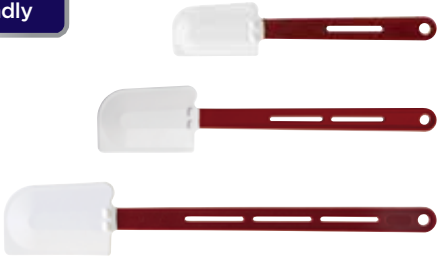

NSF

BPA FREE

PSH-SERIES

SILICONE SCRAPERS

- ◆ Features raised ridges to rest on, preventing messy counters
- ◆ Heat-resistant up to 600°F (315°C)

ITEM	DESCRIPTION	UOM	CASE
PSH-10	10-1/2"	Each	24/144
PSH-14	14"	Each	24/144
PSH-16	16-1/4"	Each	24/144



PSH-series features silicone ridges to elevate the blade from surfaces



BPA FREE

PSG-SERIES

BOWL-SHAPED SILICONE SCRAPERS

- ◆ Heat-resistant up to 500°F (260°C)

ITEM	DESCRIPTION	UOM	CASE
PSG-10	10"	Each	12/120
PSG-14	14"	Each	12/120
PSG-16	16"	Each	12/120

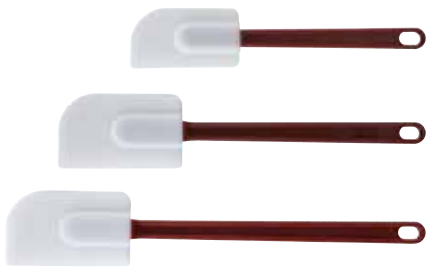

BPA FREE

PSD-SERIES

ECONOMY SILICONE SCRAPERS

- ◆ Heat-resistant up to 500°F (260°C)

ITEM	DESCRIPTION	UOM	CASE
PSD-10	10"	Each	12/120
PSD-14	14"	Each	12/120
PSD-16	16"	Each	12/120



BPA FREE

PSGE-SERIES

BOWL-SHAPED PLASTIC SCRAPERS

ITEM	DESCRIPTION	UOM	CASE
PSGE-10	10"	Each	12/120
PSGE-14	14"	Each	12/72
PSGE-16	16"	Each	12/36



NSF

BPA FREE

PSC-SERIES

PLASTIC SCRAPERS

ITEM	DESCRIPTION	UOM	CASE
PSC-10	10"	Each	24/360
PSC-14	14"	Each	12/288
PSC-16	16"	Each	12/288

TIMERS

ITEM	DESCRIPTION	TIME	UOM	CASE
TIM-78	Mechanical Timer	60 min	Each	12/36
TIM-85D	Digital Timer, (1) AAA Battery Included	20 hrs	Each	12/144

TIMERS



TIM-85D



TIM-78

STAINLESS STEEL MIXING PADDLES

ITEM	DESCRIPTION	UOM	CASE
MPD-24	24"	Each	12
MPD-36	36"	Each	12
MPD-48	48"	Each	12
MPD-60	60"	Each	12

PADDLES & SPOONS



MPD-24

WOODEN STIRRING PADDLES

ITEM	DESCRIPTION	UOM	CASE
WSP-18	18"	Each	12/36
WSP-24	24"	Each	12/36
WSP-36	36"	Each	12/36
WSP-48	48"	Each	12/36



WSP-24

BAR MAID™ NYLON SPREADERS

ITEM	DESCRIPTION	UOM	CASE
CR-925	7-3/4", 12-pcs/pk	Pack	1/12
CR-926	11-1/2", 12-pcs/pk	Pack	1/12



CR-925

CR-926



HIGH-HEAT NYLON MIXING PADDLES

Mix, fold or spread with this stain-resistant, sturdy one-piece paddle.

◆ High temperature nylon is heat-resistant up to 400°F (204°C)

ITEM	DESCRIPTION	UOM	CASE
NSP-10W	10"	Each	12/120
NSP-14W	14"	Each	12/120
NSP-20W	20"	Each	12/120



NSP-10W

NSP-SERIES



HIGH HEAT NYLON MIXING SPOONS

◆ One-piece construction, ideal for non-stick cookware
◆ Stain resistant; heat-resistant up to 400°F (204°C)

ITEM	DESCRIPTION	UOM	CASE
NS-12B	12", Blue	Each	24/144
NS-12R	12", Red	Each	24/144
NS-12T	12", Tan	Each	24/144
NS-12W	12", Off-white	Each	24/144
NS-15B	15", Blue	Each	24/72
NS-15R	15", Red	Each	24/72
NS-15T	15", Tan	Each	24/72
NS-15W	15", Off-white	Each	24/72



NS-15B

NS-15R

NS-15T

NS-15W

NS-SERIES



WOODEN MIXING SPOONS

ITEM	DESCRIPTION	UOM	CASE
WWP-12	12"	Doz	1/8
WWP-14	14"	Doz	1/8
WWP-16	16"	Doz	1/8
WWP-18	18"	Doz	1/8



WWP-SERIES



MEASURING CUPS & SPOONS

NSF PMCP-SERIES



DELUXE POLYCARBONATE MEASURING CUPS

- ◆ Molded one-piece break-resistant polycarbonate; heat-resistant up to 210°F (98°C)
- ◆ Raised markings in both quarts (red letters) and liters (blue letters)
- ◆ Tapered open handle for a secure grip; stackable
- ◆ Dishwasher safe

ITEM	DESCRIPTION	UOM	CASE
PMCP-25	1 Cup	Each	6/72
PMCP-50	1 Pint	Each	6/72
PMCP-100	1 Qt	Each	6/36
PMCP-200	2 Qt	Each	6/36
PMCP-400	4 Qt	Each	6/24
PMCP-5SET	Complete 5-Pc Set	Set	1/6

NSF PMU-SERIES



POLYCARBONATE MEASURING CUPS

- ◆ Raised graduation markings

ITEM	DESCRIPTION	UOM	CASE
PMU-25	1 Cup	Each	36
PMU-50	1 Pint	Each	36
PMU-100	1 Qt	Each	36
PMU-200	2 Qt	Each	36
PMU-400	4 Qt	Each	12



MSL-5S

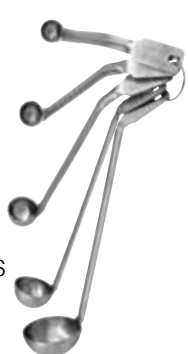

MSL-11



1 8/8 STAINLESS STEEL MINI MEASURING LADLES

- ◆ Ideal for either measuring or serving small quantities
- ◆ Capacity stamped on each handle

ITEM	DESCRIPTION	UOM	CASE
MSL-5S	5-Pc Set: 1/8 Tsp, 1/4 Tsp, 1/2 Tsp, 1 Tsp, 1 Tbsp	Set	12/72
MSL-11	3/4 Tbsp	Each	60/300



MSP-4P



MSPD-4X

STAINLESS STEEL MEASURING SPOON SETS

- ◆ Sets includes: 1/4 Tsp, 1/2 Tsp, 1 Tsp, 1 Tbsp

ITEM	DESCRIPTION	UOM	CASE
MSP-4P	4-Pc Set	Set	12/288
MSPD-4X	Deluxe 4-Pc Set	Set	24/240



BPA FREE

MSPP-4



BPA FREE

MCP-4

PLASTIC MEASURING SPOONS & CUPS SETS

- ◆ Spoons set includes: 1/4 Tsp, 1/2 Tsp, 1 Tsp, 1 Tbsp
- ◆ Cups set includes: 1/4 Cup, 1/3 Cup, 1/2 Cup, 1 Cup

ITEM	DESCRIPTION	UOM	CASE
MSPP-4	4-Pc Spoons Set	Set	12/216
MCP-4	4-Pc Cups Set	Set	12/72



MCP-4P



AM-2

STAINLESS STEEL MEASURING CUP SET

- ◆ Set includes: 1/4 Cup, 1/3 Cup, 1/2 Cup, 1 Cup

ITEM	DESCRIPTION	UOM	CASE
MCP-4P	4-Pc Set	Set	12/48

ALUMINUM MEASURING CUPS - QUARTS

ITEM	DESCRIPTION	UOM	CASE
AM-05	1/2 Qt	Each	1/48
AM-1	1 Qt	Each	1/36
AM-2	2 Qt	Each	1/36
AM-4	4 Qt	Each	1/24

ALUMINUM PIZZA PANS

Hand Wash

WIDE-RIM ALUMINUM PIZZA PANS

- ◆ All-purpose wide-rim pan allows for baking and serving straight out of the oven

ITEM	DESCRIPTION	UOM	CASE
APZT-7	7"	Each	36/72
APZT-8	8"	Each	36/144
APZT-9	9"	Each	36/72
APZT-10	10"	Each	36/72
APZT-11	11"	Each	36/72
APZT-12	12"	Each	36/72
APZT-13	13"	Each	36/72
APZT-14	14"	Each	24/48
APZT-15	15"	Each	24/48
APZT-16	16"	Each	24/48
APZT-17	17"	Each	12/36
APZT-18	18"	Each	12/36
APZT-19	19"	Each	12/24
APZT-20	20"	Each	12/24



APZT-SERIES



COUPE-STYLE ALUMINUM PIZZA PANS

- ◆ Ideal for baking and serving thin-crust pizzas

ITEM	DESCRIPTION	UOM	CASE
APZC-8	8"	Each	36/144
APZC-9	9"	Each	36/144
APZC-10	10"	Each	36/72
APZC-11	11"	Each	36/72
APZC-12	12"	Each	36/72
APZC-13	13"	Each	36/72
APZC-14	14"	Each	24/48
APZC-15	15"	Each	24/48
APZC-16	16"	Each	24/48
APZC-18	18"	Each	12/36



APZC-SERIES

STACKABLE ALUMINUM PIZZA PANS

- ◆ 1-1/2" pan depth
- ◆ 1" clearance between pans when stacked

ITEM	DESCRIPTION	UOM	CASE
APZK-0615	6"	Each	6/24
APZK-0815	8"	Each	6/24
APZK-1015	10"	Each	6/24
APZK-1215	12"	Each	6/12
APZK-1415	14"	Each	6/12
APZK-1615	16"	Each	6/12



APZK-1615



Stackable

PIZZA PANS



SPP-1218

SPP-1616

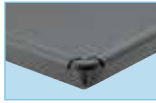

Durable
heavyweight
cold-rolled
steel



COLD-ROLLED STEEL SICILIAN PIZZA PANS

A must-have for making traditional thick-and-chewy Sicilian pizzas.

- ◆ Tapered design and fully nesting
- ◆ Non-stick coating provides an even-heat transfer
- ◆ Withstands temperatures up to 500°F (260°C)

ITEM	DESCRIPTION	UOM	CASE
SPP-1218	12"L x 18"W x 1"H	Each	12
SPP-1616	16"L x 16"W x 1"H	Each	12



HAC-162



HARD ANODIZED ALUMINUM DEEP DISH PANS

- ◆ 1.0mm, 18 gauge

ITEM	DESCRIPTION	UOM	CASE
HAC-082	8"Dia x 2"H	Each	6/24
HAC-102	10"Dia x 2"H	Each	6/24
HAC-122	12"Dia x 2"H	Each	6/24
HAC-142	14"Dia x 2"H	Each	6/24
HAC-162	16"Dia x 2"H	Each	6/12



HAC-SERIES

PIZZA SCREENS

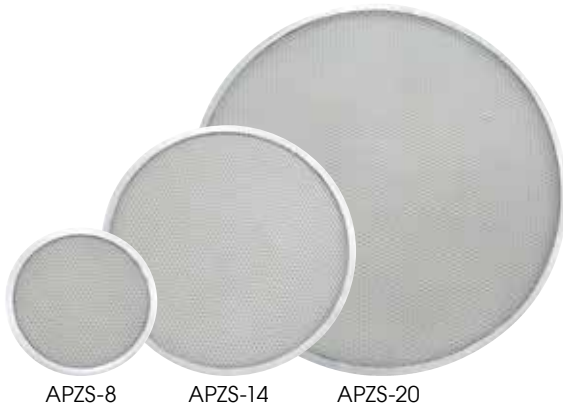

APZS-8

APZS-14

APZS-20

ALUMINUM PIZZA SCREENS

- ◆ Mesh bottom helps transfer heat to create a crispier crust

ITEM	DESCRIPTION	UOM	CASE
APZS-7	7"	Each	12/120
APZS-8	8"	Each	12/120
APZS-9	9"	Each	12/120
APZS-10	10"	Each	12/120
APZS-11	11"	Each	12/120
APZS-12	12"	Each	12/120
APZS-13	13"	Each	12/120
APZS-14	14"	Each	12/120
APZS-15	15"	Each	12/120
APZS-16	16"	Each	12/120
APZS-17	17"	Each	12/120
APZS-18	18"	Each	12/60
APZS-19	19"	Each	12/60
APZS-20	20"	Each	12/60

PIZZA PAN STAND & RACK



APZT-789



APZT-1015

PIZZA PAN TABLETOP STAND

- ◆ Simple, attractive stand raises 6-1/2" above surface
- ◆ Ideal for tabletop with limited space

ITEM	DESCRIPTION	UOM	CASE
APZT-789	Chrome Plated Steel	Each	20

PIZZA PAN TABLETOP 15-TIER RACK

- ◆ 1-5/8" spacing between each level
- ◆ Overall height: 27" tall
- ◆ Base measures 12" x 12"

ITEM	DESCRIPTION	UOM	CASE
APZT-1015	Chrome Plated Steel, Welded	Each	2

PIZZA PAN GRIPPERS

ITEM	DESCRIPTION	UOM	CASE
PPG-8	Gripper for Deep Pizza Pans	Each	12/60
PPG-8A	Heavy-duty Cast Aluminum Gripper	Each	12/48
PPG-8S	Gripper for Shallow Pizza Pans	Each	6/60

PIZZA PAN GRIPPERS



PIZZA DOUGH BUBBLE POPPERS

- ◆ Long-reach handles deflate dough bubbles while pizza is cooking in the oven

DOUGH BUBBLE POPPERS

ITEM	DESCRIPTION	O.L.	UOM	CASE
PZP-32	Aluminum	32"	Each	24/48
PZP-38WH	Wooden Handle	38"	Each	12/24



26-TIER MOBILE PIZZA PAN RACK WITH BRAKES

Each tier features an extended ledge to accommodate round or square pizza pans.

- ◆ 26-tier sturdy aluminum construction
- ◆ Designed to hold and transport 17" & 19" dia round pizza pans and 16" & 17" square Sicilian pizza pans
- ◆ 5" dia, full-swivel casters; two (2) with brake
- ◆ Capacity: up to 650 Lbs
- ◆ 2" spacing between each tier
- ◆ 4-1/8" wide ledge design
- ◆ Ships either welded or knocked down
- ◆ Fully assembled dimensions: 22"L x 20"D x 62-1/2"H

ALUMINUM 26-TIER PIZZA PAN RACK



ITEM	DESCRIPTION	UOM	CASE
AWPR-26BK	26-Tier, Welded	Each	1
ALPR-26BK	26-Tier, Knocked Down	Each	1
ALRC-5ST	Caster for ALZK & AWZK-series	Each	12
ALRC-5STK	Caster w/Brake for ALZK & AWZK-series	Each	12



ALRC-5STK
5" caster with brake

ALPR-26BK NSF
AWPR-26BK



PIZZA PEELS

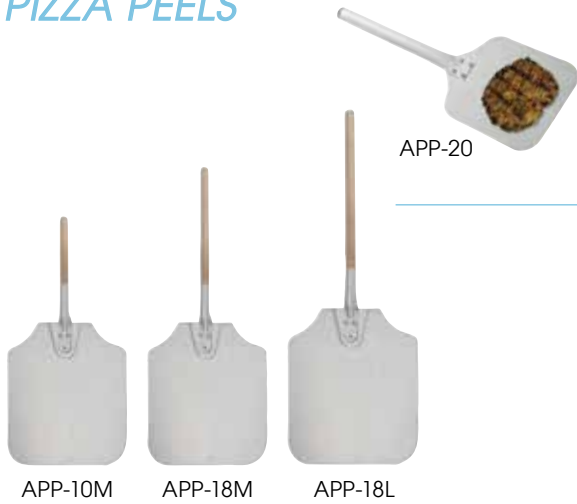

ALUMINUM PIZZA/BURGER PEEL

- ◆ 14 gauge, 1.6mm thick
- ◆ 11"L handle

ITEM	DESCRIPTION	O.L	UOM	CASE
APP-20	6-3/4" x 9" Blade	20"	Each	12/48

ALUMINUM PIZZA PEELS

- ◆ Wooden handle

ITEM	DESCRIPTION	O.L	UOM	CASE
APP-26	12" x 14" Blade	26"	Each	6/12
APP-36	12" x 14" Blade	36"	Each	6/12
APP-52	12" x 14" Blade	52"	Each	6/12
APP-10M	14" x 16" Blade	26"	Each	6/12
APP-18M	14" x 16" Blade	34"	Each	6/12
APP-18L	16" x 18" Blade	36"	Each	6/12

WOODEN PIZZA PEELS



ITEM	DESCRIPTION	O.L	UOM	CASE
WPP-1222	12" x 13" Blade	22"	Each	12
WPP-1236	12" x 13" Blade	36"	Each	12
WPP-1242	12" x 13" Blade	42"	Each	12
WPP-1424	14" x 15" Blade	24"	Each	12
WPP-1436	14" x 15" Blade	36"	Each	12
WPP-1442	14" x 15" Blade	42"	Each	12
WPP-1642	16" x 17-1/2" Blade	42"	Each	6
WPP-1842	18" x 19" Blade	42"	Each	6
WPP-2042	20" x 20" Blade	42"	Each	6

PIZZA KNIVES & CUTTERS



SOFT-TEK™ PIZZA CUTTER

The specially designed soft-touch, non-slip handle of the Sof-Tek line is also available as a pizza cutter.

- ◆ Razor sharp 4" diameter blade
- ◆ Protective finger guard

ITEM	DESCRIPTION	BLADE	UOM	CASE
KSTK-40	Sof-Tek Handle	4" Dia	Each	6/36



PIZZA CUTTERS

ITEM	DESCRIPTION	BLADE	UOM	CASE
PWC-4	Wooden Handle	4" Dia	Each	12/72
PPC-2	Black PP Hdl	2-1/2" Dia	Each	12/72
PPC-4	Black PP Hdl	4" Dia	Each	12/72
PPC-2W	White PP Hdl	2-1/2" Dia	Each	12/72
PPC-4W	White PP Hdl	4" Dia	Each	12/72
VP-315	Small, Soft Grip Handle	2-1/2" Dia	Each	12/72
VP-316	Large, Soft Grip Handle	4" Dia	Each	12/72

PIZZA KNIVES



ITEM	DESCRIPTION	UOM	CASE
KPP-18	18" Pizza Knife	Each	6/24
KPP-20	20" Pizza Rocker Knife	Each	6/24

NSF KPP-SERIES

New Item

PIZZA SERVER

- ◆ Stainless steel blade
- ◆ Reinforced ergonomic PP handle

ITEM	DESCRIPTION	UOM	CASE
TKP-62	6-7/8" x 5-7/8"	Each	6/24

PIZZA SERVERS



TKP-62 NSF

18/8 STAINLESS STEEL PIZZA SERVING TONGS

- ◆ Dishwasher Safe

ITEM	DESCRIPTION	UOM	CASE
PZG-6	5-1/2" x 4-1/2" Blade	Each	12/48



ADJUSTABLE 18/8 STAINLESS STEEL SHAKER DREDGE

- ◆ Mirror finish
- ◆ Features a three-way adjustable top with small, medium and large holes

ITEM	DESCRIPTION	UOM	CASE
DRG-8P	8 Oz	Each	12/96

DREDGES



DRG-8P adjustable top



DRG-8P

STAINLESS STEEL DREDGES

ITEM	DESCRIPTION	UOM	CASE
DRG-10	10 Oz w/ Handle	Each	12/144
DRG-10H	10 Oz w/o Handle	Each	12/144
DRG-22H	22 Oz w/o Handle	Each	12/48



DRG-10



DRG-10H



DRG-22H

ALUMINUM DREDGES

ITEM	DESCRIPTION	UOM	CASE
ADRG-10	10 Oz w/ Handle	Each	12/144
ADRG-10H	10 Oz w/o Handle	Each	12/144



ADRG-10



ADRG-10H

PLASTIC DREDGE SETS

- ◆ 10 oz capacity with snap-on lids

ITEM	DESCRIPTION	UOM	CASE
PDG-10	10 Oz w/3 Clear Lids (S,M,L)	Set	1/48
PDG-10AC	10 Oz w/4 Colored Lids	Set	1/48
PDG-10CS	10 Oz w/Clear S Lid	Set	12/48
PDG-10CM	10 Oz w/Clear M Lid	Set	12/48
PDG-10CL	10 Oz w/Clear L Lid	Set	12/48
PDG-10CXL	10 Oz w/Clear XL Lid	Set	12/48
PDG-10B	10 Oz w/Beige Lid	Set	12/48
PDG-10G	10 Oz w/Green Lid	Set	12/48
PDG-10R	10 Oz w/Rose Lid	Set	12/48
PDG-10Y	10 Oz w/Yellow Lid	Set	12/48



PDG-10AC



PDG-10

PDG-SERIES NSF

COLORLED PLASTIC DREDGE LIDS

- ◆ Fits both PDG-10 and PDG-10AC dredges
- ◆ 6 pieces per pack

ITEM	DESCRIPTION	UOM	CASE
PDG-BL	Beige Lids, 6-Pcs/Pk	Pack	72/144
PDG-GL	Green Lids, 6-Pcs/Pk	Pack	72/144
PDG-RL	Rose Lids, 6-Pcs/Pk	Pack	72/144
PDG-YL	Yellow Lids, 6-Pcs/Pk	Pack	72/144



PDG-SERIES COLORED LIDS

DOUGH PREPARATION



ALDP-SERIES

ALUMINUM DOUGH RETARDING/PROOFING PANS & COVERS

◆ Stackable for easy storage

ITEM	DESCRIPTION	UOM	CASE
ALDP-48	48 Oz, 7-7/8"Dia x 3"H	Each	12/24
ALDP-48C	Cover for ALDP-48	Each	120
ALDP-96	96 Oz, 8-3/4"Dia x 3"H	Each	12/24
ALDP-96C	Cover for ALDP-96	Each	120

PL-36NC



PL-3N

PL-6N

POLYPROPYLENE DOUGH BOXES & COVER

◆ Boxes stack tight to maintain freshness of contents

◆ Reinforced structure resists breakage or bending over time

ITEM	DESCRIPTION	UOM	CASE
PL-3N	25-5/8"L x 18"W x 3-1/4"H	Each	6
PL-6N	25-1/2"L x 17-1/2"W x 6"H	Each	3
PL-36NC	Cover	Each	12



PL-SERIES



Stackable



Reinforced edges & corners

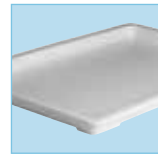

Lid can be used as a tray



Seamless fit for extra fresh storage needs

DOUGH BOX DOLLY



DWR-2617



Transport dough boxes

WIRE DOUGH BOX DOLLY

Transport multiple dough boxes with ease using this wire dolly, currently the only one on the market!

- ◆ Capacity up to 400 Lbs
- ◆ Winco® exclusive
- ◆ 3-3/4" diameter wheels

ITEM	DESCRIPTION	UOM	CASE
DWR-2617	27"L x 18-1/4"W x 2-1/2"H	Each	1
DWR-CT	Caster for DWR-2617	Each	4/24
DWR-CTB	Caster w/ Brake for DWR-2617	Each	4/24

STAINLESS STEEL MIXING PADDLES

ITEM	DESCRIPTION	UOM	CASE
MPD-24	24"	Each	12
MPD-36	36"	Each	12
MPD-48	48"	Each	12
MPD-60	60"	Each	12

MIXING PADDLES

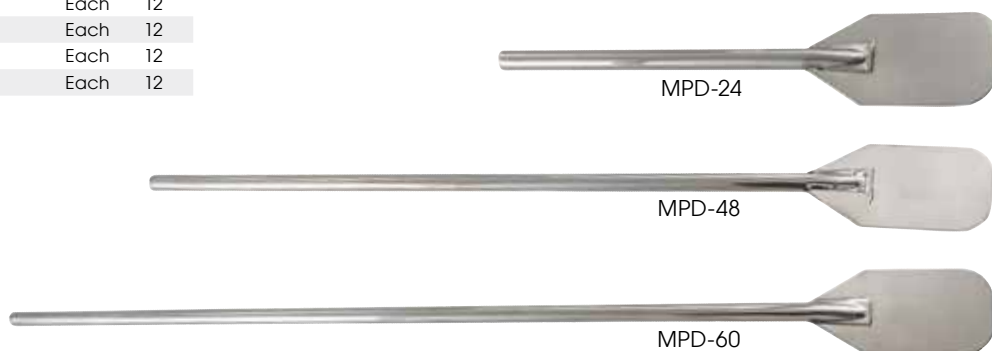

DOUGH SCRAPERS

◆ Stainless steel blade

ITEM	DESCRIPTION	SIZE (L X W)	UOM	CASE
DSC-1	Steel Handle	5-1/4" x 4-1/4"	Each	12/48
DSC-2	Plastic Handle, NSF	6" x 3"	Each	12/72
DSC-2W	Plastic Handle, NSF	6" x 3"	Each	12/72
DSC-3	Wooden Handle	6" x 3"	Each	12/72



DOUGH SCRAPERS



BAR MAID® WHITE PLASTIC BOWL SCRAPER

ITEM	DESCRIPTION	SIZE	UOM	CASE
CR-899	Small, 250-Pcs/Pk	5-1/2" x 3-3/4"	Case	1



CR-899

WHITE PLASTIC DOUGH SCRAPERS

ITEM	DESCRIPTION	SIZE (L X W)	UOM	CASE
PDS-7	Large, 6-Pcs/Pk	7-1/2" x 4-3/4"	Pack	24/48
PDS-5	Small, 12-Pcs/Pk	5-1/2" x 3-3/4"	Doz	21/42



PDS-7 NSF

PDS-5 NSF

ALLERGEN-FREE DOUGH SCRAPERS

Whether it's gluten, nuts or more, use this stand-out purple color to designate these dough scrapers as allergen-free.

Refer to Allergen-Free Utensils for purple handle collection



ITEM	DESCRIPTION	SIZE (L X W)	UOM	CASE
DSC-2P	Dough Scraper, Plstc Hdl, S/S Blade	6" x 3"	Each	12/72
PDS-7P	Plastic Dough Scrapers, 6-Pcs/Pk	7-1/2" x 4-3/4"	Pack	24/48



DSC-2P



PDS-7P NSF



ROLLING PINS



ARP-15



WRP-18



WRP-20F

ALUMINUM ROLLING PINS

◆ 3-1/2" diameter; Hand wash only, do not submerge

ITEM	DESCRIPTION	UOM	CASE
ARP-13	13"L	Each	1/6
ARP-15	15"L	Each	1/6
ARP-18	18"L	Each	1/6

WOODEN ROLLING PINS

◆ 2-3/4" diameter; Hand wash only, do not submerge

ITEM	DESCRIPTION	UOM	CASE
WRP-13	13"L	Each	12
WRP-15	15"L	Each	12
WRP-18	18"L	Each	12

FRENCH WOODEN ROLLING PIN

◆ 1-3/16" diameter; Hand wash only, do not submerge

ITEM	DESCRIPTION	UOM	CASE
WRP-20F	20" Tapered	Each	12/48

DOUGH WHEELS/DOCKERS

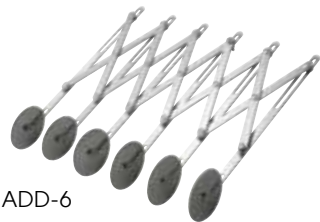

ADD-6

ADJUSTABLE DOUGH DIVIDERS

◆ Stainless steel wheels adjust width from 3/4" to about 4-3/8" apart for ADD-5 & to about 4-3/4" for ADD-6

ITEM	DESCRIPTION	UOM	CASE
ADD-5	5-Wheel	Each	36
ADD-6	6-Wheel	Each	36

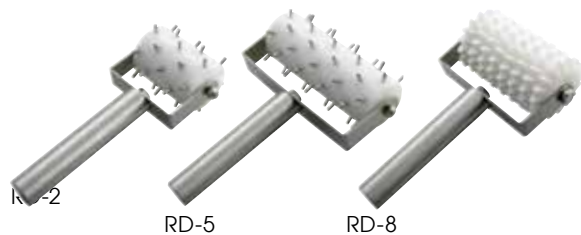

RD-2

RD-5

RD-8

DOUGH ROLLER DOCKERS

◆ Stainless steel handle

◆ 8" Overall Length

ITEM	DESCRIPTION	UOM	CASE
RD-2	2-5/8"W Head	Each	1/24
RD-5	5"W Head	Each	1/24
RD-8	5"W Head, 8-Wheel	Each	1/24

PLASTIC ROLLER DOCKERS

◆ Prevent bubbles from forming

◆ RD-4P: 6 wheels spin independently

ITEM	DESCRIPTION	UOM	CASE
RD-4P	4"W Head, 6 Wheels, Molded Ergonomic Handle	Each	1/24
RD-5P	5"W Head, Plastic Handle	Each	12/72



RD-4P

RD-5P

ROTARY SIFTER



RFS-8

STAINLESS STEEL ROTARY SIFTER

ITEM	DESCRIPTION	UOM	CASE
RFS-8	8 Cup, S/S	Each	1/12



DUAL-HEAD WIRE BRISTLE BRUSH

- ◆ Thin steel bristle brush side with 1-1/2" L wire
- ◆ Thick steel bristle brush side with 1-1/4" L flat wire
- ◆ Wire scrubbing head measures 7-3/4" wide x 2-5/8" deep x 7" high (wire to wire)
- ◆ Stainless steel handle with 20" long reach; 6" long bent end provides leverage to reach and scrub

ITEM	DESCRIPTION	UOM	CASE
BR-21	Dual Wire Brush with S/S Handle	Each	6

PIZZA OVEN CLEANING BRUSHES



BR-21

PIZZA OVEN/BROILER DUAL-SIDE WIRE BRUSH

- ◆ Stiff stainless steel wire bristles effortlessly clean heavy carbon deposits and oven residue

ITEM	DESCRIPTION	UOM	CASE
BR-30	Dbl-Side Wire Brush w/30" Hdl	Each	8/32

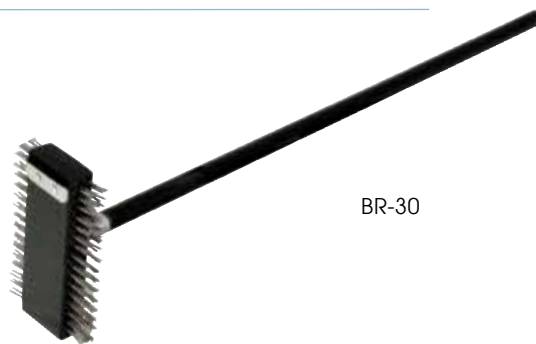

BR-30

PIZZA OVEN WIRE BRUSH WITH SCRAPER

- ◆ Carbon wire bristles with attached metal scraper
- ◆ Sturdy wooden handle

ITEM	DESCRIPTION	UOM	CASE
BR-27	Brush & Scraper w/27" Hdl	Each	12



BR-27

PIZZA OVEN WIRE BRUSH HEAD & HANDLES

- ◆ Brass wire bristles and metal scraper

ITEM	DESCRIPTION	UOM	CASE
BR-10	Brush & Scraper, 10-1/4" x 1-3/8" x 1-3/4"	Each	12/48
BR-36W	36" Wooden Hdl for BR-10	Each	48
BR-60W	55" Wooden Hdl for BR-10	Each	6/24



BR-10



BR-36W



BR-60W



DELIVERY BAGS



Premium Food Delivery Bags

"The delivery solution engineered for savings and functionality."



BGCB-1212 worn cross-body



BGCB-1212 (S)



(M) Includes divider



BGCB-1709 (M)

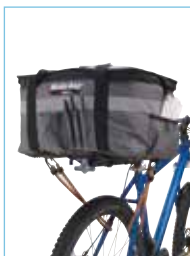

BGCB-1709 using anchor straps



WINGO BAG™ PREMIUM CATERING BAGS

The delivery solution engineered for savings and functionality.

- ◆ High-performance insulation retains temperature
- ◆ Waterproof liner prevents leaking and is easy to clean
- ◆ Integrated reinforced bottom for stability
- ◆ Built-in rubber feet reduce wear and tear over time
- ◆ Moisture-resistant exterior prevents bacteria, mold, odors
- ◆ Clear pockets positioned for storing slips, menus, or to add custom branding
- ◆ Anchor strap to secure bag - ideal for bike and scooter delivery (*cord not included*)
- ◆ Reflector strip for safety
- ◆ Removable 12 compartment divider to keep beverages, soups and other liquids upright and organized (*divider comes with BGCB-1709 only*)

ITEM	DESCRIPTION	UOM	CASE
BGCB-1212	12"W x 12"D x 12"H (S)	Each	1/6
BGCB-1709	17"W x 13"D x 9"H (M), Beverage Divider	Each	1/6
BGCB-2314	23"W x 15"D x 14"H (L)	Each	1/4
BGCB-2212	22"W x 22"D x 12"H (XL)	Each	1/4



BGCB-2314 (L)



BGCB-2212 (XL)



WINGO BAG™ PREMIUM BACKPACK

Delivery on the GO with ease and comfort.

- ◆ High-performance insulation retains temperature
- ◆ Adjustable contoured straps and padded back, ideal for bike and scooter delivery
- ◆ Waterproof liner prevents leaking and is easy to clean
- ◆ Integrated reinforcements for lightweight bag stability
- ◆ Dual close zipper and buckle to keep contents secure
- ◆ Clear pocket with zipper closure for storing slips, menus, or to add custom branding
- ◆ Built-in rubber feet reduce wear and tear over time
- ◆ Moisture-resistant exterior prevents bacteria, mold, odors
- ◆ Reflector strip for safety
- ◆ Holds up to (8) medium-size containers



BGDB-1616



ITEM	DESCRIPTION	UOM	CASE
BGDB-1616	16"W x 13"D x 16"H	Each	1/4

Restaurant



Catering



Delivery



WINGO BAG™ PREMIUM PIZZA BAGS

Constructed from sturdy 3-layer fabric, maintains food temperature for longer without condensation buildup.

- ◆ Breathable liner reduces condensation
- ◆ Insulated flaps help retain temperature
- ◆ Dual closure velcro and buckle to keep contents secure
- ◆ Multiple straps for secure hold and stability
- ◆ Hanging loop for storage/drying
- ◆ Clear pockets positioned for storing slips, menus, or to add custom branding
- ◆ Reflector strip for safety
- ◆ Pizza box capacities: (M) holds (4) 16" / (L) holds (3) 18"

ITEM	DESCRIPTION	UOM	CASE
BGPZ-1909	19"W x 19"D x 9"H (M)	Each	1/6
BGPZ-2109	21-1/2"W x 21-1/2"D x 9"H (L)	Each	1/6



Restaurant



Catering



Delivery



Strap on bottom, top and sides for easy transport

DELIVERY BAGS



Premium Pizza Delivery Bags

"The delivery solution engineered for savings and functionality."



BGPZ-1909 (M)

BGPZ-2109 (L)

PIZZA & MORE DELIVERY BAGS

From kitchen to table, our insulated delivery bags maintain temperature over standard delivery range.

- ◆ Outer shell / liner: polyester, Filling: EPE
- ◆ Insulated liner retains heat for 2 hours @ 167°F / for 4 hours @ 131° / for 6 hours @ 95°F

ITEM	DESCRIPTION	UOM	CASE
BGDV-12	12" x 12" x 12"	Each	6
BGDV-22	22" x 22" x 12"	Each	6
BGPZ-18	18" x 18" x 5" Pizza Bag	Each	6
BGPZ-20	20" x 20" x 5" Pizza Bag	Each	6
BGPZ-24	24" x 24" x 5" Pizza Bag	Each	6



BGPZ-SERIES



BGDV-22



BGDV-12

FOOD SCALES



NSF SCAL-D22

DIGITAL PORTION-CONTROL SCALE

- ◆ 6" x 6" stainless steel platform can be used as a tray
- ◆ Piece count, unit and tare functions
- ◆ Measures in five different units - lb:oz, lb, oz, kg, g
- ◆ Includes three AAA batteries and AC adapter
- ◆ 2-1/2"L x 1"W backlight LCD screen

ITEM	DESCRIPTION	CAPACITY	UOM	CASE
SCAL-D22	Digital Scale	22 Lb / 10 kg	Set	1/36

Large platform



Shatter-proof lens

SCAL-840

MECHANICAL STAINLESS STEEL RECEIVING SCALES

- ◆ Large, stable platform
- ◆ Shatter-proof lens protects dial
- ◆ Default calibration is pounds

ITEM	DESCRIPTION	CAPACITY	GRADATIONS	UOM	CASE
SCAL-62	6.5" Dial	2 Lb / 1 kg	1/4 Oz / 5 g	Each	8
SCAL-66	6.5" Dial	6 Lb / 3 kg	1/2 Oz / 10 g	Each	8
SCAL-810	8" Dial	10 Lb / 4.55 kg	1 Oz / 25 g	Each	6
SCAL-820	8" Dial	20 Lb / 9.09 kg	1 Oz / 50 g	Each	6
SCAL-840	8" Dial	40 Lb / 18.18 kg	2 Oz / 100 g	Each	6
SCAL-960	9" Dial	60 Lb / 27.27 kg	4 Oz / 100 g	Each	2
SCAL-9100	9" Dial	100 Lb / 45.45 kg	4 Oz / 100 g	Each	2
SCAL-9130	9" Dial	130 Lb / 59.09 kg	8 Oz / 200 g	Each	2

FOOD MILLS



SVM-12

LARGE 5QT FOOD MILL

- ◆ Comes with five interchangeable cutting plates with varying perforations for a variety of textures
- ◆ Four with round perforations of 8mm, 4mm, 3mm or 2mm diameter, and one with rectangular 3 x 8.5mm
- ◆ Output is approximately 3 lbs per minute and fits on a 7" or larger receptacle

ITEM	DESCRIPTION	SIZE	UOM	CASE
SVM-12	5 Qt	12-3/4"Dia	Set	1/4



SVM-3

MEDIUM 2QT FOOD MILLS

- ◆ Stainless steel

ITEM	DESCRIPTION	SIZE	UOM	CASE
SVM-3	2 Qt w/4 Graters	8"Dia	Set	1/8
SVM-9	2 Qt w/3 Graters	9"Dia	Set	1/6



SVM-9

PREMIUM MANDOLINE SLICERS

- ◆ **MDL-18** features rubberized handle for a non-slip grip and rotary side dial for precise thickness control.
- ◆ Includes three (3) built-in blade styles at varying thicknesses:
 - ◆ SLICE – 1/8", 1/4", 3/8"
 - ◆ SERRATED/WAFFLE – 1/8", 1/4", 3/8"
 - ◆ JULIENNE – 1/8", 3/8"
- ◆ **MDL-15** includes five (5) interchangeable blades
- ◆ Non-skid stand for stability, folds for compact storage
- ◆ Easy-clean stainless steel body
- ◆ Each set includes an easy-grip stainless steel hand guard

ITEM	DESCRIPTION	UOM	CASE
MDL-18	Mandoline Slicer Set, 3 Built-in Blade Styles	Set	1/8
MDL-15	Mandoline Slicer Set, 5 Interchangeable Blades	Set	1/8
MDL-BLD	5-Blade Set for MDL-15	Set	12/48
MDL-HD	Hand Guard for MDL-15	Each	12/36

MANDOLINE SLICERS



MANDOLINE SLICER SET

- ◆ Built-in julienne, and reversible slicing & serrated blades at varying thicknesses
- ◆ Non-skid, folding stand for compact storage
- ◆ Rotary adjustment dial
- ◆ Plastic body with rubberized; easy-grip hand guard

ITEM	DESCRIPTION	UOM	CASE
MDL-4P	Mandoline Slicer Set	Set	1/8

JAPANESE MANDOLINE SLICER SET

- ◆ Sharp blades cut clean, uniform slices
- ◆ Built-in blade adjusts to desired thickness
- ◆ Great for carrots, onions, cucumbers and more
- ◆ Hand guard included

ITEM	DESCRIPTION	UOM	CASE
MDL-5P	Japanese Mandoline Slicer Set	Set	1/36
MDL-5PBS	3-Blade Set for MDL-5P	Set	1

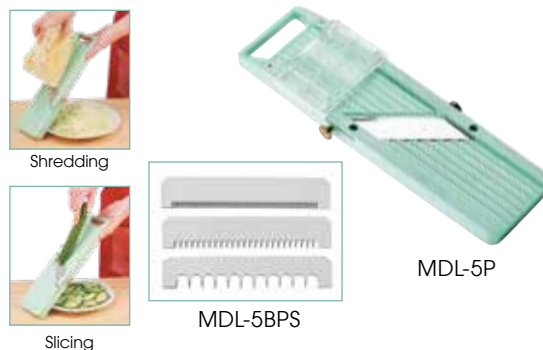

STAINLESS STEEL UTILITY PAIL

- ◆ Durable, versatile, with sturdy handle for easy transport
- ◆ Transport ice, merchandise cold beverages, catch clamshells and more

ITEM	DESCRIPTION	UOM	CASE
UP-13	13 Qt	Each	12

13QT UTILITY PAIL



CAST ALUMINUM PAIL OPENER

- ◆ Open large bucket/pail lids with the wide pry hook
- ◆ Close lids with built-in hammer for a tight seal

ITEM	DESCRIPTION	UOM	CASE
POA-8	Pail Opener, 8-1/2"L	Each	6/72

BUCKET / PAIL OPENER



SLICERS & CHOPPER



5"W x 2-1/4"D slot

NSF BGS-1

PLASTIC BAGEL SLICER WITH SERRATED BLADE

- ◆ High-carbon, non-stick blade with serrated edge provides precise cuts with every slice
- ◆ Clear guard allows visibility & protects hands/fingers from injury
- ◆ Wide base helps maintain stability while in use
- ◆ Dishwasher safe

ITEM	DESCRIPTION	UOM	CASE
BGS-1	7"L x 3-1/2"W x 9"H	Set	1/12
BGS-1B	Replacement Blade with Guard	Each	1/12



VTS-3G

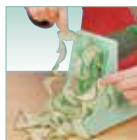

TURNING SLICER

- ◆ Produce beautiful vegetable strands and curly ribbons in minutes with a turn of the handle
- ◆ Includes plastic turner, built-in straight blade, and 3 interchangeable fine, medium, coarse blades

ITEM	DESCRIPTION	UOM	CASE
VTS-3G	11"L x 5"W x 7-3/8"H	Each	1/12
VTS-3GBS	Serrated Blade Set for VTS-3G, 3-Pc: Coarse, Medium, Fine	Set	30



AP-12



TRIPLE-FUNCTION APPLE PEELER

Peel, slice, and core in one motion.

- ◆ Cast aluminum body with sharp stainless steel blade
- ◆ Suction base holds peeler securely to any smooth surface
- ◆ Disassembles for cleaning
- ◆ Also ideal for sturdy fruits and root vegetables

ITEM	DESCRIPTION	UOM	CASE
AP-12	10"L x 6"W x 4-1/4"H	Set	1/12



FCS-3



FOOD CHOPPER

- ◆ 18/8 stainless steel construction with plastic base
- ◆ Zigzag-shaped blade rotates for dicing
- ◆ 0.5mm blade thickness

ITEM	DESCRIPTION	UOM	CASE
FCS-3	3" Dia	Each	6/24



SRT-7

STAINLESS STEEL 7" SERRATOR

- ◆ Corrugated blade perfect for crinkle cuts

ITEM	DESCRIPTION	UOM	CASE
SRT-7	7" Blade, Wood Grip	Each	12/72

MORTAR & PESTLE



MPS-42W

MARBLE MORTAR & PESTLE SET

- ◆ Grind, crush, blend
- ◆ 4-1/2" diameter bowl

ITEM	DESCRIPTION	UOM	CASE
MPS-42W	Mortar & Pestle	Set	1/12

CHROME-PLATED STAINLESS STEEL PASTA MAKER

Roll out 7" wide, uniform dough sheets for building lasagnas and raviolis. Cut thin strands of spaghetti or wide fettuccine noodles with the dual-width cutting attachment.

- ◆ 7" long roller - dial adjusts for 9 thicknesses
- ◆ Cuts either 2mm or 8mm widths
- ◆ Clamps to work surface for secure operation
- ◆ Also ideal for rolling gum paste or fondant sheets

ITEM	DESCRIPTION	UOM	CASE
NPM-7	Pasta Maker	Set	1/6

PASTA MAKER



NPM-7

TORTILLA PRESSES

- ◆ Traditional press with excellent leverage
- ◆ Integrated handle allows for easy open and removal of corn and flour tortillas
- ◆ Great for making burritos, enchiladas and quesadillas

ITEM	DESCRIPTION	WEIGHT	UOM	CASE
TPC-8A	8"Dia, Aluminum, Non-Stick	1.52Lbs	Each	6/12
TPC-8C	8"Dia, Cast Iron	7.94Lbs	Each	1/4



TORTILLA PRESSES

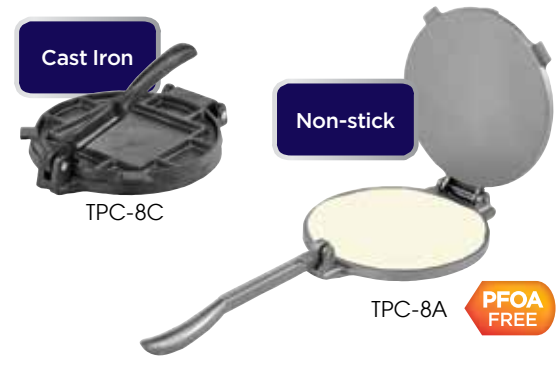

TPC-8A

PFOA FREE

EMPANADA FORK PASTRY PRESSES

Ideal for high-volume prep, this patented design significantly speeds up production and saves on time and labor costs.

- ◆ Time and labor saving
- ◆ Sturdy, long-lasting stainless steel
- ◆ 3.25" x 5" or 7" press area
- ◆ Anti-slip handle with finger grooves for comfortable grip
- ◆ Ideal for empanadas, turnovers, mini calzones, and more

ITEM	DESCRIPTION	UOM	CASE
EF-05	5"L Empanada Fork	Each	1/72
EF-07	7"L Empanada Fork	Each	48

EMPANADA FORKS

NEW



EF-07

EF-05

PREMIUM HAND-PRESS CITRUS JUICER

Extract juice from fresh fruits with ease, maximizing yield by squeezing out every last drop. The strainer catches seeds and pulp, while fresh-squeezed juice pours out.

- ◆ Sturdy, reinforced base with rubber feet prevent sliding
- ◆ Strong steel post support and smooth lever action
- ◆ Ideal for medium to small citrus fruits
- ◆ Base accommodates standard glass/cup (not included)

ITEM	DESCRIPTION	UOM	CASE
JC-19	Premium 19"H Juicer	Each	1/2

JUICER



JC-19



Base fits a standard glass/cup

STAINLESS STEEL MIXING BOWLS



MXHV-500



MXBH-500



MXBT-500Q



MXB-950Q



MXRU-SERIES



MXBS-30

HEAVY-DUTY MIXING BOWLS

ITEM	DESCRIPTION	SIZE (DIA X DEPTH)	UOM	CASE
MXHV-75	3/4 Qt	6-1/4" x 1-3/4"	Each	12/72
MXHV-150	1-1/2 Qt	7-3/4" x 2-1/4"	Each	12/36
MXHV-300	3 Qt	9-7/8" x 3"	Each	12/24
MXHV-400	4 Qt	10-5/8" x 3-1/4"	Each	12/24
MXHV-500	5 Qt	11-5/8" x 3-3/8"	Each	6/12
MXHV-800	8 Qt	13-3/4" x 5"	Each	6/12
MXHV-1300	13 Qt	16-1/4" x 4-1/2"	Each	12
MXHV-1600	16 Qt	17-3/4" x 5-1/2"	Each	12
MXHV-2000	20 Qt	18-3/4" x 5"	Each	12

DEEP MIXING BOWLS

ITEM	DESCRIPTION	SIZE (DIA X DEPTH)	UOM	CASE
MXBH-300	3 Qt	9" x 3-1/2"	Each	12/48
MXBH-500	5 Qt	10-1/4" x 4-1/2"	Each	12/36
MXBH-800	8 Qt	12" x 5"	Each	12/24
MXBH-1300	13 Qt	15" x 5-3/4"	Each	12

ALL-PURPOSE MIXING BOWLS

◆ True capacity for all-purpose kitchen prep work

ITEM	DESCRIPTION	SIZE (DIA X DEPTH)	UOM	CASE
MXBT-75Q	3/4 Qt	6-3/8" x 2-3/8"	Each	12/144
MXBT-150Q	1-1/2 Qt	7-7/8" x 2-7/8"	Each	12/144
MXBT-300Q	3 Qt	10-1/4" x 3-5/8"	Each	12/72
MXBT-400Q	4 Qt	11" x 3-3/4"	Each	12/72
MXBT-500Q	5 Qt	11-7/8" x 4"	Each	12/72
MXBT-800Q	8 Qt	13-3/4" x 5"	Each	12/36
MXBT-1300Q	13 Qt	16-3/8" x 5-7/8"	Each	12/24
MXBT-1600Q	16 Qt	17-7/8" x 6"	Each	12
MXBT-2000Q	20 Qt	19" x 6-5/8"	Each	12

ECONOMY MIXING BOWLS

ITEM	DESCRIPTION	SIZE (DIA X DEPTH)	UOM	CASE
MXB-75Q	3/4 Qt	6-1/4" x 1-3/4"	Each	12/144
MXB-150Q	1-1/2 Qt	7-3/4" x 2-1/2"	Each	12/144
MXB-300Q	3 Qt	9-1/2" x 3-1/2"	Each	12/72
MXB-400Q	4 Qt	10-5/8" x 3-1/2"	Each	12/72
MXB-500Q	5 Qt	11-1/2" x 3-1/2"	Each	12/72
MXB-800Q	8 Qt	13-1/4" x 4-1/8"	Each	12/36
MXB-950Q	9-1/2 Qt	15-3/8" x 4-1/4"	Each	24
MXB-1300Q	13 Qt	16" x 4-1/2"	Each	24
MXB-1600Q	16 Qt	17-3/4" x 5"	Each	12
MXB-2000Q	20 Qt	18-5/8" x 5-1/2"	Each	12
MXB-3000Q	30 Qt	22-1/2" x 7-1/2"	Each	12

SILICONE BASE MIXING BOWLS

◆ Non-skid silicone base helps to keep bowl in place while mixing and prepping

ITEM	DESCRIPTION	SIZE (DIA X DEPTH)	UOM	CASE
MXRU-150	1-1/2 Qt	6-3/4" x 3-3/4"	Each	48
MXRU-300	3 Qt	8-1/2" x 4-3/8"	Each	24
MXRU-500	5 Qt	10-1/4" x 5-5/8"	Each	24
MXRU-800	8 Qt	11-3/4" x 6-1/2"	Each	6/12

MIXING BOWL STAND

ITEM	DESCRIPTION	UOM	CASE
MXBS-30	Stand for MXB-3000Q	Set	1
MXBS-30-C	Caster for MXBS-30	Each	4/24

HEAVY-DUTY STAINLESS STEEL COLANDERS WITH HANDLES AND BASE

- ◆ Ideal for rinsing large fruits/vegetables, straining potatoes, or draining pastas or meats
- ◆ Tapered, high-wall cone shape
- ◆ Holes sized to keep food in but allow water to flow freely
- ◆ Durable, sturdy, easy to transport between prep stations

ITEM	DESCRIPTION	SIZE (DIA X DEPTH)	UOM	CASE
SLO-11	11 Qt	15" x 7-1/2"	Each	1
SLO-16	16 Qt	16-1/2" x 7-1/2"	Each	1

COLANDERS



SLO-16

STAINLESS STEEL ALL-PURPOSE COLANDERS WITH HANDLES AND BASE

- ◆ Tapered sides, sturdy rounded handles, footed base

ITEM	DESCRIPTION	SIZE (DIA X DEPTH)	UOM	CASE
COD-3	3 Qt	10" x 4"	Each	12/48
COD-5	5 Qt	11-5/8" x 4"	Each	24
COD-8	8 Qt	13-1/4" x 5-1/8"	Each	12
COD-14	14 Qt	16-1/4" x 5-7/8"	Each	12



COD-3

STAINLESS STEEL CHINESE-STYLE COLANDERS

- ◆ Wide, smooth-edge rim for safe and secure grip
- ◆ Coarse = 5mm diameter drain holes
- ◆ Fine = 2-1/2mm diameter drain holes

ITEM	DESCRIPTION	SIZE (DIA X DEPTH)	UOM	CASE
CCOD-11L	5-1/4 Qt, Coarse	11-3/4" x 4"	Each	24
CCOD-13L	9 Qt, Coarse	14-1/8" x 4-3/4"	Each	24
CCOD-15L	13-3/4 Qt, Coarse	16-3/8" x 5-1/8"	Each	12
CCOD-11S	5-1/4 Qt, Fine	12" x 4"	Each	24
CCOD-13S	9 Qt, Fine	15" x 4-1/2"	Each	24
CCOD-15S	13-3/4 Qt, Fine	16-3/8" x 5-1/2"	Each	12



CCOD-11S



CCOD-15L

ALUMINUM COLANDERS WITH HANDLES AND BASE

- ◆ Riveted handles for added strength and easy transport
- ◆ Flat and sturdy footed base for raised draining

ITEM	DESCRIPTION	SIZE (DIA X DEPTH)	UOM	CASE
ALO-8BH	8 Qt	12" x 5"	Each	6
ALO-11BH	11 Qt	15" x 5-3/4"	Each	6
ALO-16BH	16 Qt	16-1/2" x 7-1/8"	Each	4



ALO-16BH

ALUMINUM COLANDERS WITHOUT BASE

- ◆ Traditional tapered sides

ITEM	DESCRIPTION	SIZE (DIA X DEPTH)	UOM	CASE
ALO-12	12 Qt	13-1/2" x 5-1/2"	Each	12
ALO-16	16 Qt	16" x 8"	Each	12
ALO-16H	16 Qt	16-1/8" x 8"	Each	6



ALO-16H



ALO-12

BATTER DISPENSERS



ALUMINUM PANCAKE BATTER DISPENSER

- ◆ Dispense a consistent amount of batter
- ◆ 88oz (11 cups) overall capacity
- ◆ 8 portion-control settings range from 1oz to 3oz
- ◆ 10-gauge high-grade aluminum body
- ◆ Long lasting parts prevent clogging and leaking

ITEM	DESCRIPTION	UOM	CASE
APCD-6	Batter Dispenser, Alu	Each	1/6
APCD-6R	Rack for APCD-6	Each	12/48



APCD-6 & APCD-6R



CONFECTIONERY FUNNEL

- ◆ Use to dispense a smooth flow of fondant, syrup or prepared creams
- ◆ Spring valve feature allows for easy control with single-handed operation
- ◆ Comes with 3 nozzles: 4mm, 5mm, 6mm
- ◆ Rack sold separately

ITEM	DESCRIPTION	UOM	CASE
SF-7	Confectionery Funnel, S/S	Each	1/8
SF-7R	Rack for SF-7, S/S	Each	1/24

BUTTER ROLLER



18/8 STAINLESS STEEL 1/6 SIZE BUTTER ROLLER

- ◆ Fits into 7"L x 6-3/8"W size opening
- ◆ Spreads butter evenly, reducing butter/dressing waste
- ◆ Roller is removable for easy cleaning
- ◆ Safe, sanitary, quick prep

ITEM	DESCRIPTION	UOM	CASE
SPBR-604	7"L x 6-3/8"W	Each	1/6

CONDIMENT DISPENSERS



18/8 STAINLESS STEEL CONDIMENT DISPENSER

- ◆ Ideal for high-volume food service environments
- ◆ Two (2) 3-1/2 Qt plastic fountain jars included (7 Qt total) - remove for easy cleaning & refilling
- ◆ Each pump dispenses between 1 oz and 1-1/4 oz portions
- ◆ Overall dimensions: 11"L x 8-3/4"W x 16"H (with pump)

ITEM	DESCRIPTION	UOM	CASE
PKTS-2D	Condiment Dispenser with 2 Standard Pumps	Set	1
PKTS-PT01	Individual Pump with Lid	Each	20
PKTS-PT02	Replacement Plastic Fountain Jar	Each	6
PKTS-PT03	Stainless Steel Casing	Each	1

BPA FREE

PUMP DISPENSER WITH 3 RESTRICTORS SET

- ◆ Perfect for condiments, hand sanitizer and hand soap
- ◆ 1-1/2" dia cap fits most 1 gallon jug
- ◆ Restricts 1 oz, 3/4 oz, 1/2 oz, 1/4 oz capacities

ITEM	DESCRIPTION	UOM	CASE
PKT-1	17" O.L. Fits 1-1/2" Dia Opening	Set	12/72

8" tube can be trimmed to custom length



TMT-SERIES
as indicated 

DIGITAL THERMOMETERS

**KEEP
FOOD
SAFE**





**KEEP ON
PACE**



Winco digital thermometers are compliant with FDA standards



DIGITAL

- ◆ Easy-read LCD display and excellent, quick response times for fast temperature readings
- ◆ Step-down probe models ideal for delicate foods to avoid breaking skin

ITEM	NSF	TEMPERATURE RANGE	LCD	PROBE	GUIDELINE ON DIAL	MOUNTING / OTHER FEATURES	UOM	CASE
TMT-DG1		-40° - 302°F; -40° - 150°C	1"	4-3/4"L	Meat Cooking Temperature Guide	• Tapered Tip Probe • Protective Sleeve	Each	12/144
TMT-DG2	N/A	-49° - 392°F; -45° - 200°C	1-3/16"	4-3/4"L	Meat Cooking Temperature Guide	• Step-Down Probe • Easy-Read LCD Swivels 180°	Each	12/72
TMT-DG4		-40° - 450°F; -40° - 230°C	1-1/4"	3-1/8"L	HACCP	• Tapered Tip Probe • Hold Function	Each	3/144
TMT-DG5	N/A	-49° - 392°F; -45° - 200°C	1-3/8" Back-Lit	2-7/8"L	Meat Cooking Temperature Guide	• Min. & Max. Feature • Hold Function • Lanyard	Each	12/72
TMT-DG6	N/A	-58 - 572°F; -50 - 300°C	1-7/8"	6"L		• Step-Down Probe • Flip-Down Stand • Magnet Included	Set	24/96
TMT-DG7		-40° - 572°F; -40° - 300°C	1-1/2"	4"L		• Thermocouple • 1.5mm Step-Down Folding Probe • Hold & Auto-Off Functions • Calibratable	Each	12/72
TMT-WD2		-40° - 450°F; -40° - 232°C	1-3/8"W	2-3/4"L		• 1.5mm Step-Down Folding Probe • Auto-Off Function • Lanyard Included	Each	12/96

WATERPROOF DIGITAL THERMOMETERS

- ◆ Compact thermometers provide fast temperature readings for liquids or solids
- ◆ Protective sleeve included
- ◆ Step-down probe models ideal for delicate skinned foods

ITEM	NSF	TEMPERATURE RANGE	LCD	PROBE	MOUNTING / OTHER FEATURES	UOM	CASE
TMT-WD1		-58° - 392°F; -50° - 200°C	7/8"	2-3/4"L	• Tapered Tip Probe • Hold Function	Each	24/96
TMT-WD3		-40° - 500°F; -40° - 260°C	1"W	5"L	• 1.5mm Step-Down Probe • Min./Max. and Hold Functions • Antimicrobial Sleeve • Calibratable	Each	24/72

INFRARED THERMOMETER

- ◆ Point at surface to get an accurate temperature reading, with no risk of cross-contamination.
- ◆ Distance to spot ratio 12:1

ITEM	NSF	TEMPERATURE RANGE	LCD	PROBE	MOUNTING / OTHER FEATURES	UOM	CASE
TMT-IF1	N/A	-26° - 608°F; -32° - 320°C	1" Back-Lit	N/A	• Auto Temp. Hold • Auto Off When Idle 20 Seconds • Laser ON/OFF	Each	12/48

THERMOMETERS

NSF TMT-SERIES
as indicated

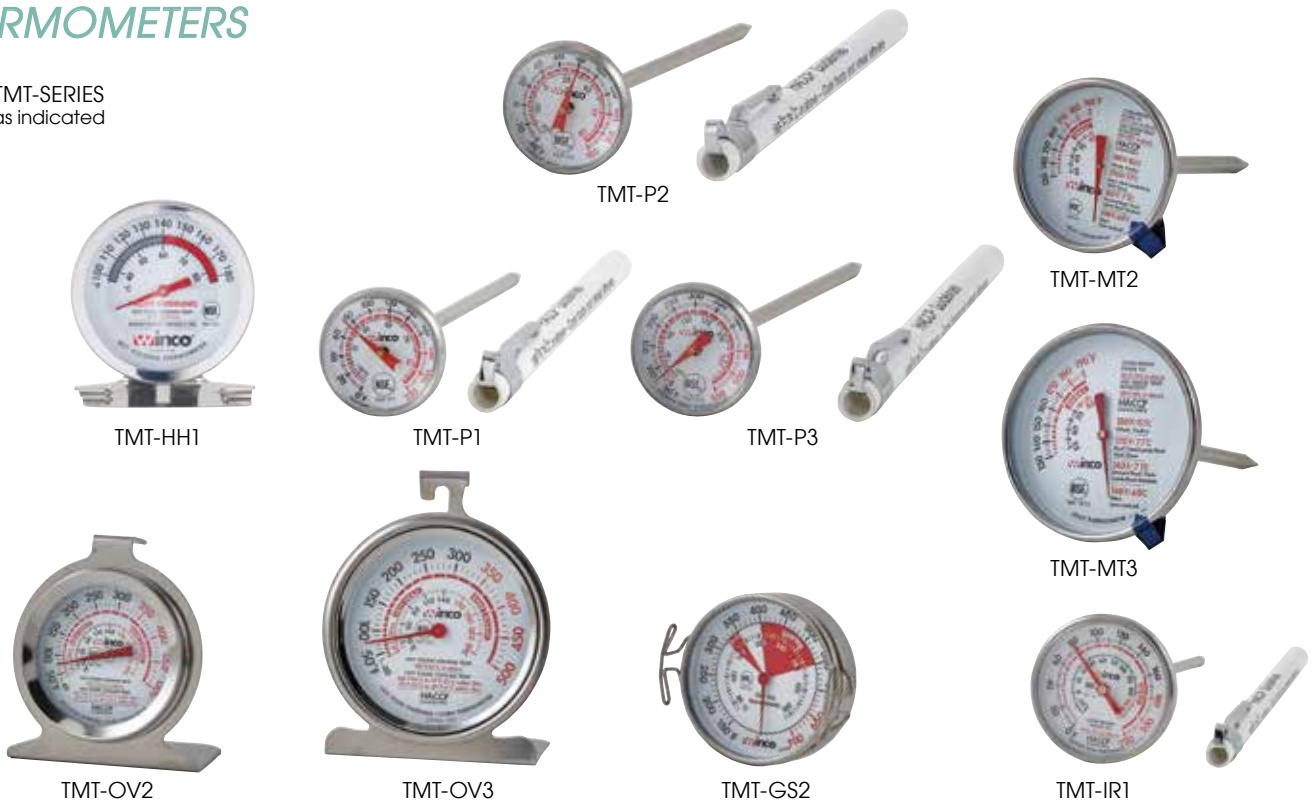

TMT-HH1



TMT-P2



TMT-MT2



TMT-P1



TMT-P3



TMT-MT3



TMT-OV2



TMT-OV3



TMT-GS2



TMT-IR1

HOT HOLDING

◆ Hang or stand-alone

ITEM	NSF	TEMPERATURE RANGE	DIAL FACE	GUIDELINE ON DIAL	UOM	CASE
TMT-HH1		100° - 180°F; 38° - 82°C	2" Dia	HACCP	Each	12/96

POCKET TEST

◆ Includes protective sleeve with built-in clip
◆ Calibrate for accuracy

ITEM	NSF	TEMPERATURE RANGE	DIAL FACE	PROBE	GUIDELINE ON DIAL	UOM	CASE
TMT-P1		0 - 220°F; -18 - 104°C	1" Dia	5"L	HACCP	Each	12/72
TMT-P2		-40 - 180°F; -40 - 80°C	1" Dia	5"L	HACCP	Each	12/72
TMT-P3		50 - 550°F; 10 - 288°C	1" Dia	5"L	HACCP	Each	12/144

MEAT

◆ Hand held with adjustable indicator

ITEM	NSF	TEMPERATURE RANGE	DIAL FACE	PROBE	GUIDELINE ON DIAL	UOM	CASE
TMT-MT2		130 - 190°F; 55 - 85°C	2" Dia	5"L	HACCP	Each	12/144
TMT-MT3		130 - 190°F; 55 - 85°C	3" Dia	5"L	HACCP	Each	12/72

OVEN

◆ Hanging hook and standing panel are built-in

ITEM	NSF	TEMPERATURE RANGE	DIAL FACE	GUIDELINE ON DIAL	UOM	CASE
TMT-OV2		40 - 500°F; 10 - 260°C	2" Dia	HACCP	Each	12/144
TMT-OV3		40 - 500°F; 10 - 260°C	3" Dia	HACCP	Each	12/144

GRILL FACE

◆ Flat surface for grill-top

ITEM	NSF	TEMPERATURE RANGE	DIAL FACE	UOM	CASE
TMT-GS2		150 - 700°F; 70 - 370°C	2" Dia	Each	3/144

INSTANT READ

◆ Includes protective sleeve with built-in clip
◆ Calibratable for accuracy

ITEM	NSF	TEMPERATURE RANGE	DIAL FACE	PROBE	GUIDELINE ON DIAL	UOM	CASE
TMT-IR1		0 - 220°F; -18 - 104°C	1-3/4" Dia	5"L	HACCP	Each	12/72

THERMOMETERS

TMT-SERIES
as indicated



TMT-CDF4



TMT-FT1



TMT-IO1



TMT-CDF5



TMT-CDF3



TMT-CDF2



TMT-RF4



TMT-RF3



TMT-RF2



TMT-RF1

FROTHING

- ◆ Includes pot clip
- ◆ Calibrate for accuracy

ITEM	NSF	TEMPERATURE RANGE	DIAL FACE	PROBE	OC AVAILABLE	UOM	CASE
TMT-FT1		0-220°F -18-104°C	1" Dia	5"L	Optional	Each	12/144

CANDY/DEEP FRYER

- ◆ Includes pot clip
- ◆ Calibrate for accuracy

ITEM	NSF	TEMPERATURE RANGE	DIAL FACE	PROBE	GUIDELINE ON DIAL	OTHER FEATURES	UOM	CASE
TMT-CDF2		100-400°F; 40-200°C	2" Dia	6"L	HACCP	• Adjustable Indicator • Calibratable	Each	12/144
TMT-CDF3		100-400°F; 40-200°C	2" Dia	12"L	HACCP	• Adjustable Indicator • Calibratable	Each	12/144
TMT-CDF4	N/A	100-400°F; 40-200°C	2" x 11-3/4"	N/A	N/A	• Top Hanging • Vertical Read	Each	12/72
TMT-CDF5		100-500°F; 40-260°C	3" Dia	12"L	HACCP	• Adjustable Indicator • Calibratable	Each	6/36

REFRIGERATOR/FREEZER

ITEM	NSF	TEMPERATURE RANGE	DIAL FACE	GUIDELINE ON DIAL	MOUNTING	UOM	CASE
TMT-RF1		-26-86°F; -30-30°C	2-7/8" x 5/8"	N/A	Suction Cup Included	Pack	12/144
TMT-RF2		-20-70°F; -30-21°C	2" Dia	HACCP	Built-in Hanging Hook & Standing Panel	Each	12/72
TMT-RF3		-20-70°F; -30-21°C	3" Dia	HACCP	Built-in Hanging Hook & Standing Panel	Each	12/72
TMT-RF4		-20-80°F; -28-26°C	3-1/2" x 1-1/8"	HACCP	Suction Cup Included	Each	12/72

INDOOR / OUTDOOR

- ◆ Weather resistant, rust proof
- ◆ Install with hanging hook or double-sided adhesive (included)

ITEM	NSF	TEMPERATURE RANGE	DIAL FACE	UOM	CASE
TMT-IO1	N/A	-40° - 120°F; -40° - 50°C	1-3/4" Dia	Each	12/144



STATIK BOARD™ CUTTING BOARDS

STATIKboard™



Original design



Edges of the non-slip feet help prevent boards from sliding when stored upright without racks



CBN-SERIES



STATIK BOARD™ CUTTING BOARDS

The patented original design of STATIK BOARD™ puts safety first with molded-through, non-slip feet that prevent slipping & sliding, even on wet countertops. Rubberized sides of the board help maintain an upright storage position without sliding. They hold firm, are sturdy, and the fully-rubberized hook makes them easy to store and transport.

- ◆ Built-in hook for easy transport and hygienic storage
- ◆ Rubberized feet grip flat surfaces; rubberized sides keep the board upright without sliding
- ◆ Available in three (3) popular sizes
- ◆ HACCP color-coding system to minimize cross-contact
- ◆ Tough board surface reduces knife dulling; durable co-polymer prevents warping
- ◆ Dishwasher safe

ITEM	DESCRIPTION	COLOR	UOM	CASE
CBN-1218BN	12" x 18" x 1/2"	Brown	Each	6
CBN-1218BU	12" x 18" x 1/2"	Blue	Each	6
CBN-1218GR	12" x 18" x 1/2"	Green	Each	6
CBN-1218PP	12" x 18" x 1/2"	Purple	Each	6
CBN-1218RD	12" x 18" x 1/2"	Red	Each	6
CBN-1218WT	12" x 18" x 1/2"	White	Each	6
CBN-1218YL	12" x 18" x 1/2"	Yellow	Each	6
CBN-1520BN	15" x 20" x 1/2"	Brown	Each	6
CBN-1520BU	15" x 20" x 1/2"	Blue	Each	6
CBN-1520GR	15" x 20" x 1/2"	Green	Each	6
CBN-1520PP	15" x 20" x 1/2"	Purple	Each	6
CBN-1520RD	15" x 20" x 1/2"	Red	Each	6
CBN-1520WT	15" x 20" x 1/2"	White	Each	6
CBN-1520YL	15" x 20" x 1/2"	Yellow	Each	6
CBN-1824BN	18" x 24" x 1/2"	Brown	Each	6
CBN-1824BU	18" x 24" x 1/2"	Blue	Each	6
CBN-1824GR	18" x 24" x 1/2"	Green	Each	6
CBN-1824PP	18" x 24" x 1/2"	Purple	Each	6
CBN-1824RD	18" x 24" x 1/2"	Red	Each	6
CBN-1824WT	18" x 24" x 1/2"	White	Each	6
CBN-1824YL	18" x 24" x 1/2"	Yellow	Each	6



STATIK BOARD™ GARNISH CUTTING BOARD

Same great board in small size.

- ◆ Built-in hook
- ◆ Molded through non-slip feet
- ◆ Reduces knife dulling and resists warping
- ◆ Dishwasher safe

ITEM	DESCRIPTION	COLOR	UOM	CASE
CBN-610WT	6" x 10" x 1/2"	White	Each	20

STATIK BOARD™ CUTTING BOARDS

Same great board in full color.

- ◆ Built-in hook for easy transport and hygienic storage
- ◆ Rubberized feet grip flat surfaces; rubberized sides keep the board upright without sliding
- ◆ Available in three (3) popular sizes
- ◆ HACCP color-coding system to minimize cross-contact
- ◆ Tough board surface reduces knife dulling; durable co-polymer prevents warping
- ◆ Dishwasher safe

ITEM	DESCRIPTION	COLOR	UOM	CASE
CBK-1218BN	12" x 18" x 1/2"	Brown	Each	6
CBK-1218BU	12" x 18" x 1/2"	Blue	Each	6
CBK-1218GR	12" x 18" x 1/2"	Green	Each	6
CBK-1218RD	12" x 18" x 1/2"	Red	Each	6
CBK-1218YL	12" x 18" x 1/2"	Yellow	Each	6
CBK-1520BN	15" x 20" x 1/2"	Brown	Each	6
CBK-1520BU	15" x 20" x 1/2"	Blue	Each	6
CBK-1520GR	15" x 20" x 1/2"	Green	Each	6
CBK-1520RD	15" x 20" x 1/2"	Red	Each	6
CBK-1520YL	15" x 20" x 1/2"	Yellow	Each	6
CBK-1824BN	18" x 24" x 1/2"	Brown	Each	6
CBK-1824BU	18" x 24" x 1/2"	Blue	Each	6
CBK-1824GR	18" x 24" x 1/2"	Green	Each	6
CBK-1824RD	18" x 24" x 1/2"	Red	Each	6
CBK-1824YL	18" x 24" x 1/2"	Yellow	Each	6

Edges of the non-slip feet help prevent boards from sliding when stored upright without racks

STATIK BOARD™ CUTTING BOARDS

STATIKboard™

Original design



CBK-SERIES

NSF

BPA FREE



CUTTING BOARDS



NSF

BPA FREE

CBWT-SERIES
CBH-SERIES
CBXH-SERIES



WHITE RECTANGULAR CUTTING BOARDS

ITEM	DESCRIPTION	UOM	CASE
CBWT-610	6" x 10" x 1/2"	Each	20
CBWT-1218	12" x 18" x 1/2"	Each	6
CBWT-1520	15" x 20" x 1/2"	Each	6
CBWT-1824	18" x 24" x 1/2"	Each	6
CBWT-1830	18" x 30" x 1/2"	Each	6
CBH-1218	12" x 18" x 3/4"	Each	6
CBH-1520	15" x 20" x 3/4"	Each	6
CBH-1824	18" x 24" x 3/4"	Each	6
CBXH-1218	12" x 18" x 1"	Each	4
CBXH-1520	15" x 20" x 1"	Each	4
CBXH-1824	18" x 24" x 1"	Each	4



CBI-1520

NSF

BPA FREE

CBI-SERIES



WHITE CUTTING BOARDS WITH CHANNEL

◆ Full-perimeter channel catches juices reduces mess and increases efficiency

ITEM	DESCRIPTION	UOM	CASE
CBI-1218	12" x 18" x 1/2"	Each	6
CBI-1520	15" x 20" x 1/2"	Each	6
CBI-1824	18" x 24" x 1/2"	Each	6
CBI-1824H	18" x 24" x 3/4"	Each	6

CUTTING BOARD RACKS

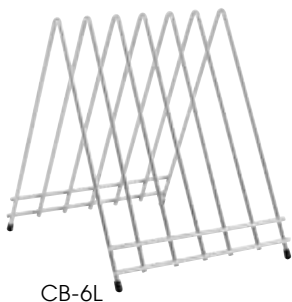

CB-6L



CB-6K

Non-slip feet



CUTTING BOARD RACKS

- ◆ Fits cutting boards up to 1" thick
- ◆ 9" x 12" rack footprint
- ◆ Horizontal bar at bottom elevates boards off surface

ITEM	DESCRIPTION	UOM	CASE
CB-6L	6 Slots, Chrome Plated	Each	6/12
CB-6K	6 Slots, Vinyl Coated	Each	10



Boards shown with CB-6L rack



Accessory hooks

Boards & brush shown with CB-6K rack

CLEANING BRUSHES



Thorough, all-around cleaning

BPA FREE

BRV-10



VEGETABLE CLEANING BRUSH

- ◆ Rigid polyester bristles effectively remove dirt and impurities from vegetable skins
- ◆ Comfortable, easy-grip ergonomic handle
- ◆ Built-in hole for convenient hanging storage

ITEM	DESCRIPTION	COLOR	UOM	CASE
BRV-10	9-1/4"L x 4-3/4"W, Plastic Handle	White	Each	12/48



Reaches into narrow bottle necks

BPA FREE

BRB-12



BOTTLE CLEANING BRUSH

- ◆ Ergonomic handle helps to reduce strain when washing bottles, glasses, pitchers or carafes
- ◆ Soft, durable polyester bristles effectively remove residue without scratching
- ◆ Built-in hole for convenient hanging storage

ITEM	DESCRIPTION	COLOR	UOM	CASE
BRB-12	12"L x 2-3/4" Dia, Plastic Handle	White	Each	12/48

HACCP COLOR-CODED CUTTING BOARDS

ITEM	DESCRIPTION	COLOR	UOM	CASE
CBBN-1218	12" x 18" x 1/2"	Brown	Each	6
CBBU-1218	12" x 18" x 1/2"	Blue	Each	6
CBGR-1218	12" x 18" x 1/2"	Green	Each	6
CBRD-1218	12" x 18" x 1/2"	Red	Each	6
CBYL-1218	12" x 18" x 1/2"	Yellow	Each	6
CBBN-1520	15" x 20" x 1/2"	Brown	Each	6
CBBU-1520	15" x 20" x 1/2"	Blue	Each	6
CBGR-1520	15" x 20" x 1/2"	Green	Each	6
CBRD-1520	15" x 20" x 1/2"	Red	Each	6
CBYL-1520	15" x 20" x 1/2"	Yellow	Each	6
CBBN-1824	18" x 24" x 1/2"	Brown	Each	6
CBBU-1824	18" x 24" x 1/2"	Blue	Each	6
CBGR-1824	18" x 24" x 1/2"	Green	Each	6
CBRD-1824	18" x 24" x 1/2"	Red	Each	6
CBYL-1824	18" x 24" x 1/2"	Yellow	Each	6

HACCP COLOR-CODED CUTTING BOARDS & MATS



COLORED CUTTING BOARDS

NSF

BPA FREE

HACCP COLOR-CODED FLEXIBLE CUTTING MATS

- ◆ Mat flexes to easily transport food to cookware or storage
- ◆ Safe, easy to clean and complies with color-coding standards for food preparation hygiene
- ◆ Made of 1/16" thick polyethylene; will not crack or chip
- ◆ Six assorted colors included in set

ITEM	DESCRIPTION	COLOR	UOM	CASE
CBF-1218	12" x 18"	Assorted	Set	12
CBF-1520	15" x 20"	Assorted	Set	12
CBF-1824	18" x 24"	Assorted	Set	6

Keep away from open flame. Do not put hot pans on top of mats.



CBF-SERIES

NSF

BPA FREE

HACCP COLOR-CODED CUTTING BOARD SETS

- ◆ Six assorted colors included in set

ITEM	DESCRIPTION	COLOR	UOM	CASE
CBST-1218	12" x 18" x 1/2"	Assorted	Set	1
CBST-1520	15" x 20" x 1/2"	Assorted	Set	1
CBST-1824	18" x 24" x 1/2"	Assorted	Set	1

STANDARD COLOR CODING SYSTEM		
Raw Meats	Raw Poultry	Vegetable & Fruit
Bakery & Dairy	Cooked Meats	Seafood



CBST-SERIES

NSF

BPA FREE

HACCP COLOR-CODED BRUSHES

- ◆ Easy-grip contoured plastic will not rust or crack
- ◆ Firm bristles stay rooted while scrubbing

ITEM	DESCRIPTION	COLOR	UOM	CASE
CBR-WT	6-1/2"L x 2-1/2"W	White	Each	24/96
CBR-BN	6-1/2"L x 2-1/2"W	Brown	Each	24/96
CBR-BU	6-1/2"L x 2-1/2"W	Blue	Each	24/96
CBR-GR	6-1/2"L x 2-1/2"W	Green	Each	24/96
CBR-RD	6-1/2"L x 2-1/2"W	Red	Each	24/96
CBR-YL	6-1/2"L x 2-1/2"W	Yellow	Each	24/96

CUTTING BOARD CLEANING BRUSHES



CBR-SERIES

WOODEN CUTTING BOARDS



WCB-1824

WOODEN CUTTING BOARDS

- ◆ 1-3/4" thick durable hardwood
- ◆ Cut-out handles on sides for easy handling
- ◆ Hand wash only

ITEM	DESCRIPTION	UOM	CASE
WCB-1218	12" x 18"	Each	1/2
WCB-1520	15" x 20"	Each	1/2
WCB-1824	18" x 24"	Each	1
WCB-1830	18" x 30"	Each	1



WCB-1218



WCB-2016



WOODEN CARVING BOARD WITH CHANNEL

This solid, natural birch wood carving board ideal for back of house prep as well as front of house carving stations and presentations.

- ◆ Wider channel on one side catches larger scraps
- ◆ Non-skid rubber feet elevate and hold board steady
- ◆ Hand wash only

ITEM	DESCRIPTION	UOM	CASE
WCB-2016	20" x 16" x 1"	Each	4



Non-skid elevated feet



Wider channel on one side to catch larger scraps



WCB-125

WOODEN CUTTING/SERVING BOARDS

- ◆ Hand wash only

ITEM	DESCRIPTION	UOM	CASE
WCB-125	12" x 5" x 3/4"	Each	24
WCB-225	22-1/2"L x 5-1/2"W x 3/4"H	Each	12



WCB-225



Shown with
cheese knife
set #KCS-6

Avoiding Cross-Contact

Equip your kitchen for allergen safety & prevent cross-contact, with our **purple Allergen-Free tools**.



Winco offers a complete line of tools to implement an allergen-free or gluten-free program in your establishment.

All items are **purple** in color, which easily identifies them for "**allergen-free**" use in the kitchen, preventing cross-contamination and enabling you to honor guests' dietary requirements.

ALLERGEN-FREE KITCHEN TOOLS



SBS-11PP

ALLERGEN-FREE PURPLE SILICONE BAKING MATS

- ◆ Double-sided and reusable up to 2,000 times
- ◆ Provides consistent and even heat distribution
- ◆ Woven fiberglass coated with food-grade silicone
- ◆ Temperature tolerance from -40°F to 480°F

ITEM	DESCRIPTION	SIZE	UOM	CASE
SBS-11PP	1/4-Size	8-1/4" x 11-3/4"	Each	20/100
SBS-16PP	1/2-Size	11-5/8" x 16-1/2"	Each	10/50
SBS-21PP	2/3-Size	14-7/16" x 20-1/2"	Each	10/50
SBS-24PP	Full-Size	16-3/8" x 24-1/2"	Each	10/50

6-Pcs/Pk



NSF PDS-7P



DSC-2P

ALLERGEN-FREE DOUGH SCRAPERS

- ◆ Designate purple for allergen-free food prep

ITEM	DESCRIPTION	SIZE	UOM	CASE
DSC-2P	Dough Scraper, Plstc Hdl, S/S Blade	6" x 3"	Each	12/72
PDS-7P	Plastic Dough Scrapers, 6-Pcs/Pk	7-1/2" x 4-3/4"	Pack	24/48



UTPH-9P



BFM-A100

ALLERGEN-FREE STAINLESS STEEL UTILITY TONGS

- ◆ Non-slip PP handle, heat resistant up to 220°F

ITEM	DESCRIPTION	SIZE	UOM	CASE
UTPH-9P	S/S Utility Tongs	9"	Each	6/72
UTPH-12P	S/S Utility Tongs	12"	Each	6/72
UTPH-16P	S/S Utility Tongs	16"	Each	6/72

ALLERGEN-FREE BAMBOO FOOD MARKERS

- ◆ Clearly identify allergen-free foods
- ◆ 100 pieces per pack

ITEM	DESCRIPTION	UOM	CASE
BFM-A100	Food Allergen I.D. Picks	Pack	20/200



AFP-10HP



ALLERGEN-FREE SILICONE SLEEVE

- ◆ Designate purple for allergen-free food prep

ITEM	DESCRIPTION	UOM	CASE
AFP-10HP	Fits AFP-10, ASFP-11, ASP-3, -4	Each	1/120



PECC-SERIES

NSF

BPA FREE

ALLERGEN-FREE CONTAINER COVERS

- ◆ Compatible with Winco® PCSC, PTSC, and PESC Series

ITEM	DESCRIPTION	UOM	CASE
PECC-24P	Fits 2 Qt & 4 Qt	Each	12
PECC-68P	Fits 6 Qt & 8 Qt	Each	12
PECC-128P	Fits 12 Qt, 18 Qt, 22 Qt	Each	6

STATIKboard™



CBN-1824PP

CUTTING BOARDS

CBPP-1218

ALLERGEN-FREE CUTTING BOARDS

- ◆ Reduces knife dulling and resists warping
- ◆ Dishwasher safe

ITEM	DESCRIPTION	UOM	CASE
CBN-1218PP	12" x 18" x 1/2"	Each	6
CBN-1520PP	15" x 20" x 1/2"	Each	6
CBN-1824PP	18" x 24" x 1/2"	Each	6
CBPP-1218	12" x 18" x 1/2"	Each	6

NSF

BPA FREE

ALLERGEN-FREE STAINLESS STEEL DISHERS
 ♦ Designate purple for allergen-free food prep

ITEM	DESCRIPTION	SIZE	UOM	CASE
ICD-10P	3-3/4 Oz, 2-5/8"Dia	10	Each	1/36
ICD-12P	3-1/4 Oz, 2-1/2"Dia	12	Each	1/36
ICD-16P	2-3/4 Oz, 2-1/4"Dia	16	Each	1/36
ICD-20P	2 Oz, 2-1/8"Dia	20	Each	1/36

ALLERGEN-FREE KITCHEN TOOLS



ICD-16P

ICD-SERIES



ALLERGEN-FREE STAINLESS STEEL ONE-PIECE PORTIONERS

ITEM	DESCRIPTION	UOM	CASE
FPS-2P	2 Oz, Solid	Each	12/72
FPS-4P	4 Oz, Solid	Each	12/72
FPS-6P	6 Oz, Solid	Each	12/72
FPP-2P	2 Oz, Perforated	Each	12/72
FPP-4P	4 Oz, Perforated	Each	12/72
FPP-6P	6 Oz, Perforated	Each	12/72



FPS-4P

FPP-4P

ALLERGEN-FREE STAINLESS STEEL ONE-PIECE LADLES

ITEM	DESCRIPTION	HANDLE	UOM	CASE
LDC-2P	2 Oz	12-1/2"	Each	12/120
LDC-4P	4 Oz	15-1/2"	Each	12/120
LDC-6P	6 Oz	15-1/2"	Each	12/120

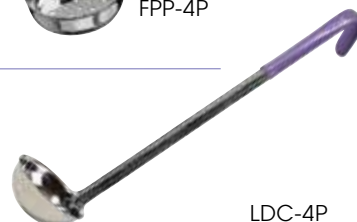

LDC-4P

ALLERGEN-FREE STAINLESS STEEL TURNERS & SPATULAS

- ♦ Ergonomic slip-free grip handle reduces hand fatigue
- ♦ Satin finish

ITEM	DESCRIPTION	BLADE	UOM	CASE
TWP-31P	Sandwich Spreader	3-5/8" x 1-1/4"	Each	12/144
TWP-42P	Turner, Offset	8" x 4"	Each	12/48
TWP-51P	Pie Server, Offset*	4-5/8" x 2-3/8"	Each	12/72
TWP-60P	Fish Spatula	6-3/4" x 3-1/4"	Each	12/144
TWP-61P	Hamburger Turner, Offset*	5-1/8" x 2-7/8"	Each	12/72
TWP-90P	Flexible Turner, Offset*	8-1/4" x 2-7/8"	Each	12/48
TWP-91P	Perf Flex Turner, Offset*	8-1/4" x 2-7/8"	Each	12/48
TWPO-9P	Spatula, Offset*	8-1/2" x 1-1/2"	Each	12/72
TWPS-9P	Bakery Spatula	10" x 1-3/8"	Each	12/72

*Measurement reflects blade size not including offset

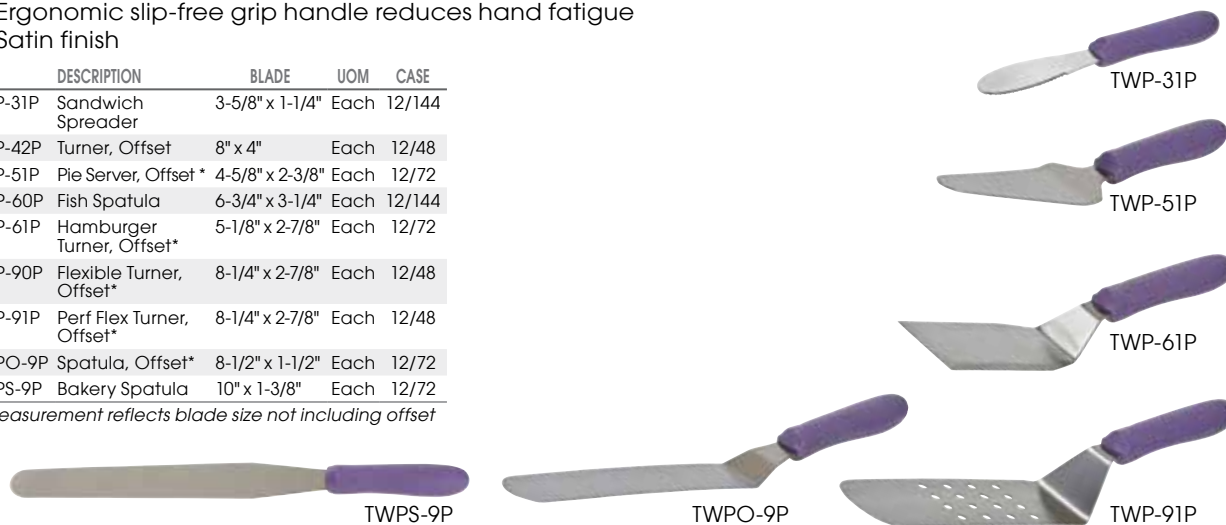

TWPS-9P

TWPO-9P

TWP-91P

TWP, TWPO & TWPS-SERIES



ALLERGEN-FREE KNIVES

- ♦ Razor-sharp X50 Cr MoV15 German steel blade
- ♦ Slip-free grip ergonomic PP handle reduces hand fatigue
- ♦ Protective finger guard
- ♦ Easy edge maintenance and rapid sharpening

ITEM	DESCRIPTION	BLADE	UOM	CASE
KWP-30P	Paring Knife, 2-Pcs/Pk	3-1/4" L	Pack	6/36
KWP-80P	Chef's Knife	8" L	Each	6/36
KWP-91P	Bread Knife, Curved	9-1/2" L	Each	6/36
KWP-100P	Chef's Knife	10" L	Each	6/36
KWP-121P	Slicer, Wavy Edge	12" L	Each	6/36



KWP-30P



KWP-80P



KWP-91P



KWP-121P



KWP-100P

KWP-SERIES



WHIPPED CREAM DISPENSER



CW-A05



Cartridge
not
included

BPA
FREE

3 DECORATING TIPS



WHIPPED CREAM DISPENSER

- ◆ Includes 3 decorating tips to create unique dessert and beverage presentations, and a brush to clean them
- ◆ Capacity: 1 Pint (0.5L)
- ◆ Fits standard 8gm N2O cartridge (*not included*) compatible with all brands of whipped cream cartridges
- ◆ Durable aluminum bottle with stainless steel handle
- ◆ Hand wash only

ITEM	DESCRIPTION	SIZE	UOM	CASE
CW-A05	Whipped Cream Dispenser with 3 Decorating Tips	3" Dia x 12"H	Each	1/12
CW-P	3 Tips With 1 Cleaning Brush		Set	1
CW-PG	Replacement Gasket, 3-Pcs/Pk		Pack	1



PLATING MOLDS



SPM-23R



SPM-21R



SPM-31R



SPM-31O



SPM-41O



SPM-211T



SPM-22S



SPM-275S



STAINLESS STEEL CULINARY PLATING MOLDS

Perfect for baking, freezing, cutting and forming, these ring molds are extremely versatile kitchen tools. Create attractive plate presentations by layering salads and grains, or bake individual cake and pastry portions without waste.

- ◆ Polished smooth to a brilliant mirror finish
- ◆ Dishwasher safe

ITEM	DESCRIPTION	UOM	CASE
SPM-21R	Round, 2"Dia x 1-3/4"H	Each	12/72
SPM-23R	Round, 2"Dia x 3"H	Each	12/72
SPM-31R	Round, 3"Dia x 1-3/4"H	Each	12/72
SPM-31O	Oval, 3"L x 1-3/8"H	Each	12/72
SPM-41O	Oval, 4"L x 1-3/8"H	Each	12/72
SPM-22S	Square, 2"L x 2"W x 2"H	Each	12/72
SPM-275S	Square, 2-3/4"L x 2-3/4"W x 2-3/4"H	Each	12/72
SPM-211T	Rectangular, 2-1/2"L x 1-3/4"W x 1-3/4"H	Each	12/72



18/8 STAINLESS STEEL PLATING TOOLS SET

All-in-one set includes five (5) plating tools and a case to protect and carry the set.

- ◆ Dishwasher safe (utensils only)

ITEM	DESCRIPTION	UOM	CASE
PTK-6SET	Plating Tools, 6-Pc/Set	Set	12/36

Set Includes:

- ◆ 8" Drizzling Spoon (SPS-TS8)
- ◆ 8" Solid Slanted Spoon (SPS-S8)
- ◆ 8" Perforated Slanted Spoon (SPS-P8)
- ◆ 8" Curved Tongs (TTG-8C)
- ◆ 8" Straight Tongs (TTG-8S)
- ◆ Carry Bag



PLATING TOOLS SET



PTK-6SET

18/8 STAINLESS STEEL DRIZZLING SPOON

Ideal for precise plating, the tapered spout allows for drizzle control and the deep bowl reduces refilling.

- ◆ Tapered spout
- ◆ Comfortable satin-finish handle
- ◆ Dishwasher safe

ITEM	DESCRIPTION	UOM	CASE
SPS-TS8	8" Drizzling w/ Tapered Spout	Each	6/72

PLATING SPOONS



SPS-TS8



18/8 STAINLESS STEEL PLATING SPOONS

Plate stylish presentations.

- ◆ Flat front solid or perforated bowl
- ◆ Comfortable satin-finish handle
- ◆ Dishwasher safe

ITEM	DESCRIPTION	UOM	CASE
SPS-S8	8" Slanted, Solid	Each	6/72
SPS-S10	10" Slanted, Solid	Each	6/72
SPS-P8	8" Slanted, Perforated	Each	6/72
SPS-P10	10" Slanted, Perforated	Each	6/72



SPS-S8



SPS-P8

18/8 STAINLESS STEEL PLATING TONGS

Plating tongs are the discerning chef's ideal tool, providing a controlled, gentle grasp of delicate garnishes for masterful placement and presentation.

- ◆ Dishwasher safe

ITEM	DESCRIPTION	UOM	CASE
TTG-8C	8" Curved	Each	24/144
TTG-10C	10" Curved	Each	24/144
TTG-8S	8" Straight	Each	24/144
TTG-10S	10" Straight	Each	24/144

PLATING TONGS



TTG-8C



TTG-10C



TTG-8S



TTG-10S





Step up to Winco® Prime – A Cut Above

Made to endure the most demanding food service environments, Winco Prime products are constructed with quality materials that comply with and exceed accepted industry standards. Winco Prime products are National Sanitation Foundation (NSF) listed, an assurance of the best food-safe materials and ease of cleaning combined with the famous Winco price/value you expect.

NSF® BAIN-MARIES



BAMN-6



BAMN-6C

WINCO® PRIME BAIN-MARIES

◆ Stainless steel satin finish

ITEM	DESCRIPTION	SIZE	UOM	CASE
BAMN-1.25	1.25 Qt	5" x 6"	Each	6/48
BAMN-1.5	1.5 Qt	5-1/2" x 5-1/4"	Each	6/48
BAMN-2	2 Qt	5-3/4" x 7"	Each	6/48
BAMN-3.5	3.5 Qt	7-1/4" x 7"	Each	6/36
BAMN-4.25	4.25 Qt	7-1/4" x 7-3/4"	Each	6/36
BAMN-6	6 Qt	8" x 8-3/4"	Each	6/24
BAMN-8.25	8.25 Qt	9" x 9-3/4"	Each	6/24
BAMN-12	12 Qt	10" x 10-1/2"	Each	6/12

BAIN-MARIE COVERS

◆ Stainless steel satin finish

ITEM	DESCRIPTION	UOM	CASE
BAMN-1.25C	Cover for BAMN-1.25	Each	12/144
BAMN-1.5C	Cover for BAMN-1.5	Each	12/144
BAMN-2C	Cover for BAMN-2	Each	12/144
BAMN-3.5C	Cover for BAMN-3.5	Each	12/144
BAMN-4.25C	Cover for BAMN-4.25	Each	12/72
BAMN-6C	Cover for BAMN-6	Each	12/72
BAMN-8.25C	Cover for BAMN-8.25	Each	12/48
BAMN-12C	Cover for BAMN-12	Each	12/24

NSF® INSETS



INSN-7



INSC-7M

WINCO® PRIME INSET PANS

◆ Stainless steel satin finish

ITEM	DESCRIPTION	SIZE	UOM	CASE
INSN-2.5	2.5 Qt	6" x 7-1/2"	Each	6/36
INSN-4	4 Qt	7-1/2" x 7-1/2"	Each	6/36
INSN-7	7 Qt	9-1/2" x 8"	Each	6/24
INSN-11	11 Qt	11-1/2" x 9"	Each	6/12

INSET COVERS (NON-NSF)

◆ Stainless steel mirror finish

ITEM	DESCRIPTION	UOM	CASE
INSC-2.5	Cover for INSN-2.5	Each	6/72
INSC-4	Cover for INSN-4	Each	6/36
INSC-7M	Cover for INSN-7	Each	6/48
INSC-11M	Cover for INSN-11	Each	6/36



Count on Winco Prime for best materials and best value



LADLES 



LDCN-SERIES



LDCN-SERIES



LDIN-SERIES



 **ONE-PIECE COLOR-CODED HANDLE LADLES**

- ◆ Color-coded for portion control
- ◆ Color matched with Winco Prime™ portioners
- ◆ 1.2mm thick stainless steel

ITEM	DESCRIPTION	COLOR	UOM	CASE
LDCN-1	1 Oz	Black	Each	12/72
LDCN-2	2 Oz	Blue	Each	12/72
LDCN-3	3 Oz	Tan	Each	12/72
LDCN-4	4 Oz	Gray	Each	12/72
LDCN-6	6 Oz	Green	Each	12/72
LDCN-8	8 Oz	Orange	Each	12/60

 **ONE-PIECE BLACK HANDLE LADLES**

- ◆ 1.2mm thick stainless steel

ITEM	DESCRIPTION	UOM	CASE
LDCN-1	1 Oz	Each	12/72
LDCN-2K	2 Oz	Each	12/72
LDCN-3K	3 Oz	Each	12/72
LDCN-4K	4 Oz	Each	12/72
LDCN-6K	6 Oz	Each	12/72
LDCN-8K	8 Oz	Each	12/60

 **ONE-PIECE STAINLESS STEEL LADLES**

- ◆ 1.0mm thick stainless steel

ITEM	DESCRIPTION	UOM	CASE
LDIN-0.5	0.5 Oz	Each	12/72
LDIN-0.75	0.75 Oz	Each	12/72
LDIN-1	1 Oz	Each	12/72
LDIN-1.5	1.5 Oz	Each	12/72
LDIN-2	2 Oz	Each	12/72
LDIN-3	3 Oz	Each	12/72
LDIN-4	4 Oz	Each	12/72
LDIN-5	5 Oz	Each	12/72
LDIN-6	6 Oz	Each	12/72
LDIN-8	8 Oz	Each	12/72
LDIN-12	12 Oz	Each	12/72



NSF[®] PORTIONERS



FPSN-SERIES

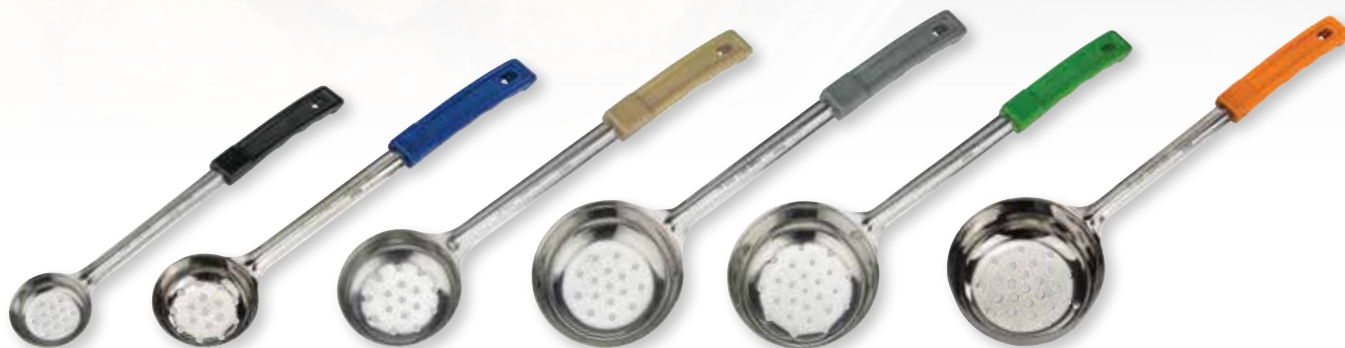

FPPN-SERIES

The Winco[®] Prime family of products are NSF[®] listed, an assurance that every effort has been made to provide a safe and durable product at an affordable price.

Count on Winco Prime, products made to endure in the most demanding food service environment!

ONE-PIECE STAINLESS STEEL PORTION CONTROLLERS

◆ 1.2mm thick stainless steel

ITEM	DESCRIPTION	STYLE	COLOR	UOM	CASE
FPSN-1	1 Oz	Solid	Black	Each	12/72
FPSN-2	2 Oz	Solid	Blue	Each	12/72
FPSN-3	3 Oz	Solid	Tan	Each	12/72
FPSN-4	4 Oz	Solid	Gray	Each	12/72
FPSN-6	6 Oz	Solid	Green	Each	12/72
FPSN-8	8 Oz	Solid	Orange	Each	12/72
FPPN-1	1 Oz	Perforated	Black	Each	12/72
FPPN-2	2 Oz	Perforated	Blue	Each	12/72
FPPN-3	3 Oz	Perforated	Tan	Each	12/72
FPPN-4	4 Oz	Perforated	Gray	Each	12/72
FPPN-6	6 Oz	Perforated	Green	Each	12/72
FPPN-8	8 Oz	Perforated	Orange	Each	12/72



Count on Winco Prime for best materials and best value



WINCO® PRIME

BASTING SPOONS



BSON



BHON



BSPN



BHPN



BSSN



BHSN

BSON, BSPN, BSSN-SERIES

BHON, BHPN, BHSN-SERIES

ONE-PIECE HEAVY-DUTY BASTING SPOONS

- ◆ 1.2mm thick stainless steel
- ◆ 18" and 21" spoons are 2.0mm stainless steel

ITEM	DESCRIPTION	HANDLE	UOM	CASE
BSON-11	11" Solid	11"	Each	12/72
BSON-13	13" Solid	13"	Each	12/72
BSON-15	15" Solid	15"	Each	12/72
BSON-18	18" Solid	18"	Each	12/72
BSON-21	21" Solid	21"	Each	12/72
BSPN-11	11" Perf'd	11"	Each	12/72
BSPN-13	13" Perf'd	13"	Each	12/72
BSPN-15	15" Perf'd	15"	Each	12/72
BSPN-18	18" Perf'd	18"	Each	12/72
BSSN-11	11" Slotted	11"	Each	12/72
BSSN-13	13" Slotted	13"	Each	12/72
BSSN-15	15" Slotted	15"	Each	12/72
BSSN-18	18" Slotted	18"	Each	12/72

BASTING SPOONS WITH STOP-HOOK ABS HANDLE

- ◆ 1.2mm thick stainless steel

ITEM	DESCRIPTION	HANDLE	UOM	CASE
BHON-11	11" Solid	11"	Each	12/72
BHON-13	13" Solid	13"	Each	12/72
BHON-15	15" Solid	15"	Each	12/72
BHPN-11	11" Perf'd	11"	Each	12/72
BHPN-13	13" Perf'd	13"	Each	12/72
BHPN-15	15" Perf'd	15"	Each	12/72
BHSN-11	11" Slotted	11"	Each	12/72
BHSN-13	13" Slotted	13"	Each	12/72
BHSN-15	15" Slotted	15"	Each	12/72





Step up to Winco® Prime – A Cut Above

NSF® **SILICONE TONGS**



From grill to freezer, these tongs handle the swing in temperature.

In HEAT
Silicone handles for superior burn protection and melt-resistance

In COLD
Silicone handles offer insulated handling and resist cracking

WINCO® PRIME SILICONE TONGS

- ◆ Stainless steel one-piece construction
- ◆ Wide range: -40°F to 500°F (-40°C to 260°C)

ITEM	DESCRIPTION	COLOR	UOM	CASE
UTSH-9K	9"	Black	Each	6/72
UTSH-9B	9"	Blue	Each	6/72
UTSH-9R	9"	Red	Each	6/72
UTSH-12K	12"	Black	Each	6/72
UTSH-12B	12"	Blue	Each	6/72
UTSH-12R	12"	Red	Each	6/72

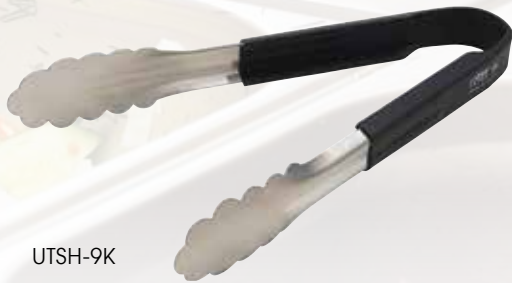

UTSH-9K



UTSH-12K

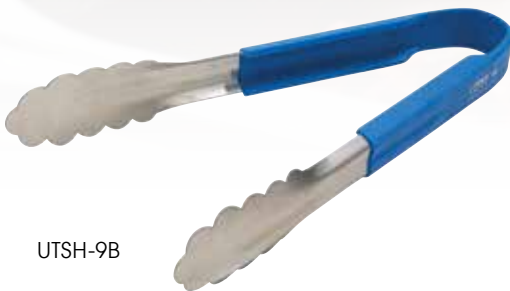

UTSH-9B



UTSH-12B



UTSH-9R



UTSH-12R



Count on Winco Prime for best materials and best value



WINCO® PRIME



18/8 STAINLESS STEEL ONE-PIECE THUMB PRESS DISHERS

- ◆ Serve consistent portions of soft foods, like rice or mashed potatoes, and ideal for portion controlled food prep of ground meat, cookie dough, and more
- ◆ Stainless steel rod reinforcement
- ◆ Smooth-action thumb press for quick release
- ◆ Handle color indicates size of scoop

ITEM	DESCRIPTION	DIA	SIZE	COLOR	UOM	CASE
ICOP-6	5-1/3 Oz	3-3/16"	6	White	Each	1/36
ICOP-8	4 Oz	2-3/4"	8	Gray	Each	1/36
ICOP-10	3-1/4 Oz	2-11/16"	10	Ivory	Each	1/36
ICOP-12	2-2/3 Oz	2-1/2"	12	Green	Each	1/36
ICOP-16	2 Oz	2-1/4"	16	Blue	Each	1/36
ICOP-20	1-5/8 Oz	2-1/8"	20	Yellow	Each	1/36
ICOP-24	1-1/3 Oz	1-7/8"	24	Red	Each	1/36
ICOP-30	1 Oz	1-3/4"	30	Black	Each	1/36
ICOP-40	3/4 Oz	1-5/8"	40	Purple	Each	1/36

DISHERS



ICOP-6



ICOP-8



ICOP-10



ICOP-12



ICOP-16



ICOP-20



ICOP-24



ICOP-30



ICOP-40



DISHERS & PORTION SERVICE



NSF ICD-SERIES

- ◆ Serve consistent portions of soft foods, like rice or mashed potatoes, and ideal for portion controlled food prep of ground meat, cookie dough, and more
- ◆ Stainless steel rod reinforcement

18/8 STAINLESS STEEL THUMB PRESS DISHERS

- ◆ Smooth-action thumb press for quick release
- ◆ Handle color indicates size of scoop

ITEM	DESCRIPTION	DIA	SIZE	COLOR	UOM	CASE
ICD-6	4-2/3 Oz	3"	6	White	Each	1/36
ICD-8	4 Oz	2-3/4"	8	Gray	Each	1/36
ICD-10	3-3/4 Oz	2-5/8"	10	Ivory	Each	1/36
ICD-12	3-1/4 Oz	2-1/2"	12	Green	Each	1/36
ICD-16	2-3/4 Oz	2-1/4"	16	Blue	Each	1/36
ICD-20	2 Oz	2-1/8"	20	Yellow	Each	1/36
ICD-24	1-3/4 Oz	2"	24	Red	Each	1/36
ICD-30	1-1/4 Oz	1-7/8"	30	Black	Each	1/36
ICD-40	7/8 Oz	1-5/8"	40	Purple	Each	1/36

Quick-release blade ensures no food left behind



ISS-SERIES

18/8 STAINLESS STEEL SQUEEZE DISHERS/PORCIONERS

- ◆ Control prep & serve portions
- ◆ Ideal for soft foods

ITEM	DESCRIPTION	DIA	SIZE	UOM	CASE
ISS-8	4 Oz	2-3/4"	8	Each	12/48
ISS-10	3-3/4 Oz	2-5/8"	10	Each	12/48
ISS-12	3-1/4 Oz	2-1/2"	12	Each	12/48
ISS-16	2-3/4 Oz	2-1/4"	16	Each	12/48
ISS-20	2-1/2 Oz	2-1/8"	20	Each	12/48
ISS-24	1-3/4 Oz	1-15/16"	24	Each	12/48
ISS-30	1-1/4 Oz	1-7/8"	30	Each	12/48
ISS-40	7/8 Oz	1-3/4"	40	Each	12/48
ISS-50	5/8 Oz	1-1/2"	50	Each	12/48
ISS-60	9/16 Oz	1-7/16"	60	Each	12/48
ISS-70	1/2 Oz	1-3/8"	70	Each	12/48
ISS-100	3/8 Oz	1-1/8"	100	Each	12/48

ICE CREAM SERVICE



AICD-12

AICD-20

CAST ALUMINUM ICE CREAM DIPPERS, SELF-DEFROSTING

- ◆ Contains a non-toxic heat conductive fluid to slightly warm the metal for easier, non-stick scooping
- ◆ Ideal bowl shape for the perfect scoop every time
- ◆ Hand wash only

ITEM	DESCRIPTION	SIZE	COLOR	UOM	CASE
AICD-12	3 Oz	12	Yellow	Each	12/144
AICD-16	2-1/2 Oz	16	Green	Each	12/144
AICD-20	2 Oz	20	Black	Each	12/144
AICD-24	1-1/2 Oz	24	Red	Each	12/144

ICE CREAM / GELATO SPADE

ITEM	DESCRIPTION	UOM	CASE
ICS-1	Ice Cream Spade	Each	12/120



ICS-1

ONE-PIECE STAINLESS STEEL LADLES

ITEM	DESCRIPTION	HANDLE	UOM	CASE
LDI-0	0.5 Oz	10-1/4"	Each	12/240
LDI-1	1 Oz	10-1/4"	Each	12/240
LDI-1.5	1.5 Oz	10-3/8"	Each	12/120
LDI-2	2 Oz	10-1/4"	Each	12/240
LDI-3	3 Oz	12"	Each	12/120
LDI-4	4 Oz	12-1/4"	Each	12/120
LDI-5	5 Oz	12-1/2"	Each	12/120
LDI-6	6 Oz	12-1/2"	Each	12/120
LDI-8	8 Oz	12-1/2"	Each	12/120
LDI-10	10 Oz	12-1/2"	Each	12/120
LDI-12	12 Oz	12-3/4"	Each	12/120
LDI-16	16 Oz	12-1/2"	Each	12/120
LDI-24	24 Oz	13"	Each	12/60

LADLES & PORTIONERS



LDI-4

LDI-24

TWO-PIECE STAINLESS STEEL LADLES

ITEM	DESCRIPTION	HANDLE	UOM	CASE
LDT-1	1 Oz	12"	Each	12/120
LDT-32	32 Oz	16"	Each	12/60



LDT-32

ONE-PIECE STAINLESS STEEL SHORT-HANDLE LADLES

ITEM	DESCRIPTION	HANDLE	UOM	CASE
LDI-05SH	0.5 Oz	6"	Each	12/120
LDI-10SH	1 Oz	6"	Each	12/120
LDI-15SH	1.5 Oz	6"	Each	12/120
LDI-20SH	2 Oz	6"	Each	12/120
LDI-30SH	3 Oz	6"	Each	12/120
LDI-40SH	4 Oz	6"	Each	12/120
LDI-60SH	6 Oz	6"	Each	12/120



LDI-30SH

ONE-PIECE STAINLESS STEEL COLOR-CODED LADLES

ITEM	DESCRIPTION	COLOR	HANDLE	UOM	CASE
LDC-05	0.5 Oz	Aqua	12"	Each	12/120
LDC-1	1 Oz	yellow	12"	Each	12/120
LDC-2	2 Oz	Red	12-1/2"	Each	12/120
LDC-3	3 Oz	Ivory	13"	Each	12/120
LDC-4	4 Oz	Green	15-1/2"	Each	12/120
LDC-6	6 Oz	Black	15-1/2"	Each	12/120
LDC-8	8 Oz	Blue	16-1/2"	Each	12/60
LDC-12	12 Oz	Gray	16-1/2"	Each	12/60



LDC-SERIES

ONE-PIECE STAINLESS STEEL PORTIONERS

ITEM	DESCRIPTION	STYLE	COLOR	UOM	CASE
FPS-1	1 Oz	Solid	Yellow	Each	12/72
FPS-2	2 Oz	Solid	Red	Each	12/72
FPS-3	3 Oz	Solid	Ivory	Each	12/72
FPS-4	4 Oz	Solid	Green	Each	12/72
FPS-6	6 Oz	Solid	Black	Each	12/72
FPS-8	8 Oz	Solid	Blue	Each	12/72
FPP-1	1 Oz	Perforated	Yellow	Each	12/72
FPP-2	2 Oz	Perforated	Red	Each	12/72
FPP-3	3 Oz	Perforated	Ivory	Each	12/72
FPP-4	4 Oz	Perforated	Green	Each	12/72
FPP-6	6 Oz	Perforated	Black	Each	12/72
FPP-8	8 Oz	Perforated	Blue	Each	12/72



FPP & FPS-SERIES

STAINLESS STEEL HOOKED-HANDLE DIPPER

◆ Gradation marks visible on inside and outside of bowl

ITEM	DESCRIPTION	HANDLE	UOM	CASE
SHHD-1	1 Qt	12"	Each	12/48



SHHD-1

UTILITY TONGS



UTPH-SERIES

Heat-resistant

HEAT RESISTANT HEAVY-DUTY UTILITY TONGS

- ◆ Stainless steel with texturized non-slip PP handle for comfort and ease of use, heat resistant up to 220°F (104°C)
- ◆ Color-coded to help prevent cross-contamination in kitchen or buffet areas

ITEM	DESCRIPTION	COLOR	UOM	CASE
UTPH-9B	9"	Blue	Each	6/72
UTPH-9G	9"	Green	Each	6/72
UTPH-9K	9"	Black	Each	6/72
UTPH-9R	9"	Red	Each	6/72
UTPH-9Y	9"	Yellow	Each	6/72
UTPH-12B	12"	Blue	Each	6/72
UTPH-12G	12"	Green	Each	6/72
UTPH-12K	12"	Black	Each	6/72
UTPH-12R	12"	Red	Each	6/72
UTPH-12Y	12"	Yellow	Each	6/72
UTPH-16B	16"	Blue	Each	6/72
UTPH-16G	16"	Green	Each	6/72
UTPH-16K	16"	Black	Each	6/72
UTPH-16R	16"	Red	Each	6/72
UTPH-16Y	16"	Yellow	Each	6/72



UT-SERIES

Cold food service only

HEAVY-DUTY STAINLESS STEEL UTILITY TONGS WITH PLASTIC HANDLE

- ◆ For cold food service only

ITEM	DESCRIPTION	COLOR	UOM	CASE
UT-9HP-B	9"	Blue	Each	12/72
UT-9HP-G	9"	Green	Each	12/72
UT-9HP-K	9"	Black	Each	12/72
UT-9HP-R	9"	Red	Each	12/72
UT-9HP-Y	9"	Yellow	Each	12/72
UT-12HP-B	12"	Blue	Each	12/72
UT-12HP-G	12"	Green	Each	12/72
UT-12HP-K	12"	Black	Each	12/72
UT-12HP-R	12"	Red	Each	12/72
UT-12HP-Y	12"	Yellow	Each	12/72
UT-16HP-B	16"	Blue	Each	12/72
UT-16HP-G	16"	Green	Each	12/72
UT-16HP-K	16"	Black	Each	12/72
UT-16HP-R	16"	Red	Each	12/72
UT-16HP-Y	16"	Yellow	Each	12/72



UT-9HT

EXTRA-HEAVYWEIGHT UTILITY TONGS

- ◆ Coiled spring
- ◆ 1.2mm thick stainless steel

ITEM	DESCRIPTION	UOM	CASE
UT-9HT	9"	Each	12/72
UT-12HT	12"	Each	12/72
UT-16HT	16"	Each	12/72



UT-9

HEAVYWEIGHT UTILITY TONGS

- ◆ Coiled spring
- ◆ 0.9mm thick stainless steel

ITEM	DESCRIPTION	UOM	CASE
UT-7	7" (Specially designed for table service)	Each	12/72
UT-9	9"	Each	12/72
UT-12	12"	Each	12/72
UT-16	16"	Each	12/72



UT-9LT

MEDIUM-WEIGHT UTILITY TONGS

- ◆ Coiled spring
- ◆ 0.6mm thick stainless steel

ITEM	DESCRIPTION	UOM	CASE
UT-9LT	9"	Each	12/72
UT-12LT	12"	Each	12/72
UT-16LT	16"	Each	12/72

NON-SCRATCH SILICONE GRIP LOCKING UTILITY TONGS

- ◆ 0.6mm thick stainless steel
- ◆ Non-stick friendly
- ◆ Pull clip to lock closed
- ◆ Heat-resistant up to 400 °F (204°C)

ITEM	DESCRIPTION	UOM	CASE
UTS-9K	9"	Each	12/72
UTS-12K	12"	Each	12/72

STAINLESS STEEL SERVING TONGS



UTS-12K

NON-SCRATCH LOCKING UTILITY TONGS

- ◆ 0.5mm thick stainless steel
- ◆ Non-stick friendly
- ◆ Slide clip toward grips to lock closed
- ◆ Heat-resistant up to 400 °F (204°C)

ITEM	DESCRIPTION	UOM	CASE
UT-7K	7"	Each	24/144



UT-7K

HEAVYWEIGHT LOCKING UTILITY TONGS

- ◆ Coil spring
- ◆ 0.9mm thick stainless steel

ITEM	DESCRIPTION	UOM	CASE
UTLK-7	7"	Each	12/72
UTLK-9	9"	Each	12/72
UTLK-12	12"	Each	12/72
UTLK-16	16"	Each	12/72



UTLK-12

POM TONGS

- ◆ One-piece smooth construction for easy cleaning
- ◆ Ideal for selecting cold foods and garnishes

ITEM	DESCRIPTION	SIZE	UOM	CASE
PT-6	Satin Finish	6"	Doz	4/24
PT-9	Satin Finish	9"	Doz	4/24



PT-9

5 PRONG TEXTURED ICE TONGS

ITEM	DESCRIPTION	SIZE	UOM	CASE
ICT-7	5 Prong, Textured	7"	Each	12/144



ICT-7

3 PRONG SATIN FINISH ICE TONGS

ITEM	DESCRIPTION	SIZE	UOM	CASE
IT-7	3 Prong, Satin Finish	7"	Each	12/120



IT-7

POM TONGS

STAINLESS STEEL SERVING TONGS



STH-8

STH-10

HEAVYWEIGHT STRAIGHT TONGS

- ◆ 18/8 satin finish stainless steel
- ◆ Dishwasher safe

ITEM	DESCRIPTION	SIZE	UOM	CASE
STH-8	Short	8.5"	Each	12/72
STH-10	Medium	10.5"	Each	12/72
STH-13	Long	13.5"	Each	12/72



SALAD TONGS

ITEM	DESCRIPTION	SIZE	UOM	CASE
PTOS-8	Oval, Satin Finish	7-3/4"	Each	12/96
ST-2	Double Spoon, Mirror Finish	10"	Each	6/60
ST-10	Fork and Spoon, Satin Finish	10"	Each	6/60
ST-10S	Slotted and Solid Spatula, Mirror Finish	10"	Each	12/96
ST-105SF	Spatula and Fork, Mirror Finish	10-1/2"	Each	12/96



PTOS-8

ST-2

ST-10S



ST-105SF

PASTRY TONGS

ITEM	DESCRIPTION	SIZE	UOM	CASE
PT-8	Solid with Short Handle	7-1/2"	Each	12/120
PT-875	Solid with Long Handle	8-3/4"	Each	12/144
PT-10P	Perforated	10-1/2"	Each	12/96

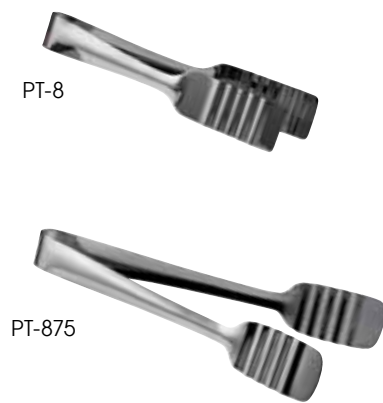

PT-8

PT-875



PT-10P

SPAGHETTI TONGS

ITEM	DESCRIPTION	SIZE	UOM	CASE
ST-8	Mirror Finish	8"	Each	12/240



ST-8

CURV™ 18/8 STAINLESS STEEL BASTING SPOONS

◆ 2.0mm thick stainless steel

ITEM	DESCRIPTION	LENGTH	UOM	CASE
SSCH-13L	Slotted	13"	Each	12/120
SSCH-13P	Perforated	13"	Each	12/120
SSCH-13S	Solid	13"	Each	12/120
SSCH-15L	Slotted	15"	Each	12/120
SSCH-15P	Perforated	15"	Each	12/120
SSCH-15S	Solid	15"	Each	12/120

STAINLESS STEEL BASTING UTENSILS

CURV™
BY WINCO®

Durable,
Functional

NEW



SSCH-15S

SSCH-13P

SSCH-13L

SSCH-SERIES



HEAVY-DUTY BASTING SPOONS

◆ 2.0mm thick stainless steel

ITEM	DESCRIPTION	UOM	CASE
BHKS-21	21" Solid	Each	6/48
BHKP-21	21" Perforated	Each	6/48



BHKS-21

BHKP-21

ONE-PIECE HEAVY-DUTY BASTING SPOONS

◆ 1.5mm thick stainless steel

ITEM	DESCRIPTION	UOM	CASE
BSOT-11H	11" Solid	Each	12/144
BSOT-13H	13" Solid	Each	12/144
BSOT-15H	15" Solid	Each	12/144
BSOT-18	18" Solid	Each	12/72
BSOT-21	21" Solid	Each	12/72
BSPT-11H	11" Perforated	Each	12/144
BSPT-13H	13" Perforated	Each	12/144
BSPT-15H	15" Perforated	Each	12/144
BSPT-18	18" Perforated	Each	12/72
BSST-11H	11" Slotted	Each	12/144
BSST-13H	13" Slotted	Each	12/144
BSST-15H	15" Slotted	Each	12/144
BSST-18	18" Slotted	Each	12/72



BSOT-11H

BSOT-18

BSPT-18

BSST-18

BASTING SPOONS

◆ 1.2mm thick stainless steel

ITEM	DESCRIPTION	UOM	CASE
BSOT-11	11" Solid	Each	12/144
BSOT-13	13" Solid	Each	12/144
BSOT-15	15" Solid	Each	12/144
BSPT-11	11" Perforated	Each	12/144
BSPT-13	13" Perforated	Each	12/144
BSPT-15	15" Perforated	Each	12/144
BSST-11	11" Slotted	Each	12/144
BSST-13	13" Slotted	Each	12/144
BSST-15	15" Slotted	Each	12/144



BSOT-13

BSPT-13

BSST-13



STAINLESS STEEL BASTING UTENSILS



BSOB-15

BSPB-15

BSSB-15

BASTING SPOONS WITH PLASTIC HANDLE

◆ 1.2mm thick stainless steel

ITEM	DESCRIPTION	UOM	CASE
BSOB-11	11" Solid	Each	12/72
BSOB-13	13" Solid	Each	12/72
BSOB-15	15" Solid	Each	12/72
BSPB-11	11" Perforated	Each	12/72
BSPB-13	13" Perforated	Each	12/72
BSPB-15	15" Perforated	Each	12/72
BSSB-11	11" Slotted	Each	12/72
BSSB-13	13" Slotted	Each	12/72
BSSB-15	15" Slotted	Each	12/72

BASTING SPOONS WITH PLASTIC STOP-HOOK HANDLE

◆ 1.2mm thick stainless steel

ITEM	DESCRIPTION	UOM	CASE
BHOP-11	11" Solid	Each	12/120
BHOP-13	13" Solid	Each	12/120
BHOP-15	15" Solid	Each	12/120
BHPP-11	11" Perforated	Each	12/120
BHPP-13	13" Perforated	Each	12/120
BHPP-15	15" Perforated	Each	12/120
BHSP-11	11" Slotted	Each	12/120
BHSP-13	13" Slotted	Each	12/120
BHSP-15	15" Slotted	Each	12/120



BHOP-15

BHPP-15

BHSP-15

BASTING FORKS

◆ 1.5mm thick stainless steel

ITEM	DESCRIPTION	UOM	CASE
BSFK-18	18"	Each	12/72
BSFK-21	21"	Each	12/72
BHKF-21	21", 2.0mm thick	Each	6/48

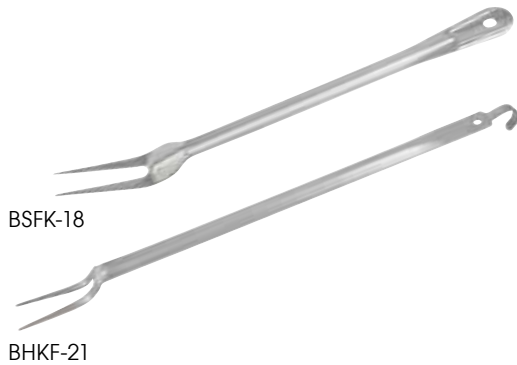

BSFK-18

BHKF-21

POLYCARBONATE SERVING UTENSILS



NSF PPT-SERIES

SPAGHETTI TONGS

◆ Heat-resistant up to 302°F (150°C)

ITEM	DESCRIPTION	SIZE	UOM	CASE
PPT-11B	Beige	11"	Each	24/144
PPT-11C	Clear	11"	Each	24/144



NSF PUTF-SERIES

PUTF-6K

FLAT TONGS

◆ Textured grip

ITEM	DESCRIPTION	SIZE	UOM	CASE
PUTF-6B	Beige	6"	Each	12/432
PUTF-6C	Clear	6"	Each	12/432
PUTF-6K	Black	6"	Each	12/432

Save money - the edges of CURV™ utensils get into tight corners and eliminate waste.

- ◆ No dripping with contoured pouring spouts
- ◆ Molded-in stopper on spoon handle prevents slipping into pan/pot
- ◆ Textured exterior finish provides a secure grip
- ◆ Easy-clean smooth, high-gloss interior finish

POLYCARBONATE SERVING UTENSILS



CURV™ ONE-PIECE DUAL SPOUT LADLES

ITEM	DESCRIPTION	SIZE	UOM	CASE
CVLD-8C	Clear 3/4 oz	8-1/2"	Each	12/144
CVLD-8K	Black 3/4 oz	8-1/2"	Each	12/144
CVLD-8R	Red 3/4 oz	8-1/2"	Each	12/144
CVLD-13C	Clear 1 oz	13"	Each	12/144
CVLD-13K	Black 1 oz	13"	Each	12/144
CVLD-13R	Red 1 oz	13"	Each	12/144

CURV™ DUAL SPOUT SERVING SPOONS

- ◆ 1-1/2 oz capacity

ITEM	DESCRIPTION	SIZE	UOM	CASE
CVSS-13C	Clear Solid	13"	Each	12/144
CVSS-13K	Black Solid	13"	Each	12/144
CVSS-13R	Red Solid	13"	Each	12/144
CVSS-15C	Clear Solid	15"	Each	12/144
CVSS-15K	Black Solid	15"	Each	12/144
CVSS-15R	Red Solid	15"	Each	12/144
CVPS-13C	Clear Perforated	13"	Each	12/144
CVPS-13K	Black Perforated	13"	Each	12/144
CVPS-13R	Red Perforated	13"	Each	12/144
CVPS-15C	Clear Perforated	15"	Each	12/144
CVPS-15K	Black Perforated	15"	Each	12/144
CVPS-15R	Red Perforated	15"	Each	12/144



CURV™ TAPERED BUFFET SPOONS

- ◆ 3/4 oz capacity

ITEM	DESCRIPTION	SIZE	UOM	CASE
CVBS-10C	Clear	10"	Each	12/144
CVBS-10K	Black	10"	Each	12/144
CVBS-10R	Red	10"	Each	12/144



CURV™ SERVING TONGS

ITEM	DESCRIPTION	SIZE	UOM	CASE
CVST-6C	Clear	6"	Each	12/144
CVST-6K	Black	6"	Each	12/144
CVST-6R	Red	6"	Each	12/144
CVST-9C	Clear	9"	Each	12/144
CVST-9K	Black	9"	Each	12/144
CVST-9R	Red	9"	Each	12/144
CVST-12C	Clear	12"	Each	12/144
CVST-12K	Black	12"	Each	12/144
CVST-12R	Red	12"	Each	12/144



STAINLESS STEEL WHIPS

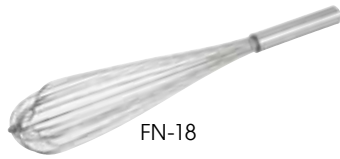
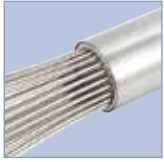

FN-18



STAINLESS STEEL FRENCH WHIPS

- ◆ Sturdy wires & solid handle
- ◆ Ideal for whipping mashed potatoes, heavy batter or sauces

ITEM	DESCRIPTION	UOM	CASE
FN-10	10"	Each	12/72
FN-12	12"	Each	12/72
FN-14	14"	Each	12/72
FN-16	16"	Each	12/60
FN-18	18"	Each	12/60
FN-20	20"	Each	12/60
FN-22	22"	Each	12/60
FN-24	24"	Each	12/60



STAINLESS STEEL PIANO WHIPS

- ◆ Mix and aerate custards and sauces
- ◆ Sturdy wires & solid handle

ITEM	DESCRIPTION	UOM	CASE
PN-10	10"	Each	12/72
PN-12	12"	Each	12/72
PN-14	14"	Each	12/72
PN-16	16"	Each	12/72
PN-18	18"	Each	12/72



PN-14

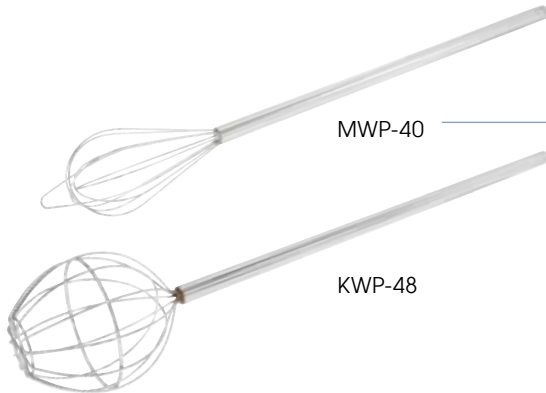

MWP-40

KWP-48

STAINLESS STEEL MAYONNAISE & KETTLE WHIPS

ITEM	DESCRIPTION	UOM	CASE
MWP-40	Mayonnaise Whip, 40"	Each	8
KWP-48	Kettle Whip, 48"	Each	8

MASHERS



PTMP-18R

PTMP-24S

PTM-18S

PTM-24R

STEEL POTATO MASHERS - PLASTIC SLEEVE GRIP

- ◆ Nickel-plated heavy duty wire

ITEM	DESCRIPTION	SIZE	UOM	CASE
PTMP-18R	4" Round	18" Handle	Each	6/12
PTMP-18S	4-1/2" Square	17-3/4" Handle	Each	6/12
PTMP-24R	5" Round	24-1/2" Handle	Each	6/12
PTMP-24S	5-1/4" Square	24" Handle	Each	6/12

STEEL POTATO MASHERS - WOODEN HANDLE

- ◆ Nickel-plated heavy duty wire

ITEM	DESCRIPTION	SIZE	UOM	CASE
PTM-18R	4" Round	18" Handle	Each	6/12
PTM-18S	4-1/2" Square	17-3/4" Handle	Each	6/12
PTM-24R	5" Round	24-1/2" Handle	Each	6/12
PTM-24S	5-1/4" Square	24" Handle	Each	6/12



PR-9



PR-16

STAINLESS STEEL POTATO RICERS

ITEM	DESCRIPTION	UOM	CASE
PR-9	Economy, Round	Each	6
PR-16	Square	Each	1/6

NON-SCRATCH NYLON COOKING TOOLS

Durable cooking tools for a variety of uses that withstand high temps and won't scuff or scratch.

- ◆ Non-stick friendly
- ◆ Heat resistant up to 410°F (210°C)

ITEM	DESCRIPTION	UOM	CASE
NC-WS	A. Slotted Spatula	Each	12/144
NC-SL2	B. Slotted Spoon	Each	12/144
NC-SS1	C. Solid Spoon	Each	12/144
NC-PF2	D. 2-Prong Fork	Each	12/144
NC-PS1	E. Pasta Fork	Each	12/144
NC-RS	F. Fish Spatula	Each	12/144
NC-LD	G. Ladle	Each	12/144
NC-MS	H. Masher	Each	12/144
NC-SK	I. Skimmer	Each	12/144
NC-WP	J. Whip	Each	12/144



NYLON COOKING TOOLS



NC-SERIES **BPA FREE**

SILICONE BRUSH

The perfect tool for brushing on marinades, oil or butter onto meats, fish or breads. Won't scratch foods or cooking surfaces.

- ◆ Non-stick friendly and easy to clean
- ◆ 100% silicone exterior; stainless steel interior
- ◆ Heat resistant up to 428°F (220°C)
- ◆ Dishwasher safe

ITEM	DESCRIPTION	UOM	CASE
SB-175R	1-3/4"W	Each	24/144

SILICONE BRUSH



SB-175R **BPA FREE**

MIXING PADDLES & SPOONS

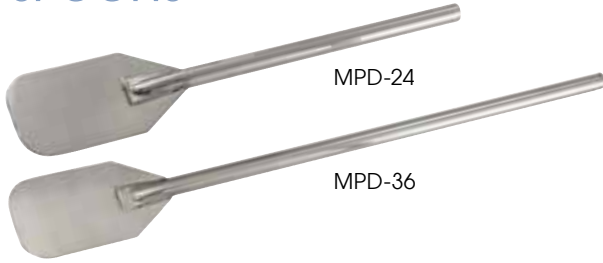

STAINLESS STEEL MIXING PADDLES

ITEM	DESCRIPTION	UOM	CASE
MPD-24	24"	Each	12
MPD-36	36"	Each	12
MPD-48	48"	Each	12
MPD-60	60"	Each	12



WOODEN STIRRING PADDLES

ITEM	DESCRIPTION	UOM	CASE
WSP-18	18"	Each	12/36
WSP-24	24"	Each	12/36
WSP-36	36"	Each	12/36
WSP-48	48"	Each	12/36



BAR MAID® NYLON SPREADERS

ITEM	DESCRIPTION	UOM	CASE
CR-925	7-3/4", 12-Pcs/Pk	Pack	1/12
CR-926	11-1/2", 12-Pcs/Pk	Pack	1/12



HIGH-HEAT NYLON MIXING PADDLES

Mix, fold or spread with this stain-resistant, sturdy one-piece paddle.

◆ High temperature nylon is heat-resistant up to 400°F (204°C)

ITEM	DESCRIPTION	UOM	CASE
NSP-10W	10"	Each	12/120
NSP-14W	14"	Each	12/120
NSP-20W	20"	Each	12/120



NSP-SERIES



HIGH-HEAT NYLON SPOONS

- ◆ Easy to clean one-piece construction
- ◆ Ideal for non-stick cookware; Stain resistant
- ◆ Heat resistant up to 400°F (204°C)

ITEM	DESCRIPTION	UOM	CASE
NS-12B	12", Blue	Each	24/144
NS-12R	12", Red	Each	24/144
NS-12T	12", Tan	Each	24/144
NS-12W	12", Off-white	Each	24/144
NS-15B	15", Blue	Each	24/72
NS-15R	15", Red	Each	24/72
NS-15T	15", Tan	Each	24/72
NS-15W	15", Off-white	Each	24/72



NS-SERIES



WOODEN SPOONS

ITEM	DESCRIPTION	UOM	CASE
WWP-12	12"	Doz	1/8
WWP-14	14"	Doz	1/8
WWP-16	16"	Doz	1/8
WWP-18	18"	Doz	1/8

SILICONE SCRAPERS

- ◆ Features raised ridges for resting to prevent messy counters
- ◆ Heat-resistant up to 600°F (315°C)

ITEM	DESCRIPTION	UOM	CASE
PSH-10	10-1/2"	Each	24/144
PSH-14	14"	Each	24/144
PSH-16	16-1/4"	Each	24/144



PSH-series features silicone ridges to elevate the blade from surfaces

SCRAPERS

Non-stick friendly



PSH-SERIES

NSF

BPA FREE

BOWL-SHAPED SILICONE SCRAPERS

- ◆ Heat-resistant up to 500°F (260°C)

ITEM	DESCRIPTION	UOM	CASE
PSG-10	10"	Each	12/120
PSG-14	14"	Each	12/120
PSG-16	16"	Each	12/120



PSG-SERIES

BPA FREE

ECONOMY SILICONE SCRAPERS

- ◆ Heat-resistant up to 500°F (260°C)

ITEM	DESCRIPTION	UOM	CASE
PSD-10	10"	Each	12/120
PSD-14	14"	Each	12/120
PSD-16	16"	Each	12/120

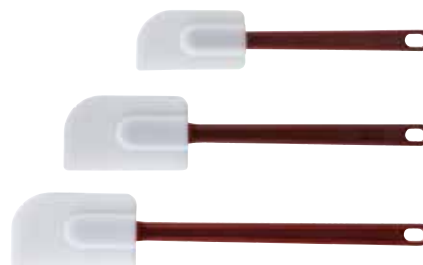

PSD-SERIES

BPA FREE

BOWL-SHAPED PLASTIC SCRAPERS

ITEM	DESCRIPTION	UOM	CASE
PSGE-10	10"	Each	12/120
PSGE-14	14"	Each	12/72
PSGE-16	16"	Each	12/36



PSGE-SERIES

BPA FREE

PLASTIC SCRAPERS

ITEM	DESCRIPTION	UOM	CASE
PSC-10	10"	Each	24/360
PSC-14	14"	Each	12/288
PSC-16	16"	Each	12/288



PSC-SERIES

NSF

BPA FREE

MINI MEASURING LADLES



MINI 18/8 STAINLESS STEEL MEASURING LADLES

- ◆ Portion and serve smaller quantities
- ◆ Capacity stamped on each handle

ITEM	DESCRIPTION	UOM	CASE
MSL-5S	5-Pc Set: 1/8 Tsp, 1/4 Tsp, 1/2 Tsp, 1 Tsp, 1 Tbsp	Set	12/72
MSL-11	3/4 Tbsp	Each	60/300

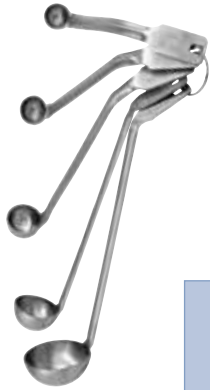

MSL-5S



MSL-11



MEASURING SPOONS

STAINLESS STEEL MEASURING SPOON SETS

- ◆ Set includes: 1/4 Tsp, 1/2 Tsp, 1 Tsp, 1 Tbsp

ITEM	DESCRIPTION	UOM	CASE
MSP-4P	4-Pc Set	Set	12/288
MSPD-4X	Deluxe 4-Pc Set	Set	24/240



MSP-4P



MSPD-4X



PLASTIC MEASURING SPOON SET

- ◆ Set includes: 1/4 Tsp, 1/2 Tsp, 1 Tsp, 1 Tbsp

ITEM	DESCRIPTION	UOM	CASE
MSPP-4	4-Pc Set	Set	12/216



BPA FREE

MSPP-4

PLASTIC MEASURING CUPS



PLASTIC MEASURING CUP SET

- ◆ Set includes: 1/4 Cup, 1/3 Cup, 1/2 Cup, 1 Cup

ITEM	DESCRIPTION	UOM	CASE
MCPP-4	4-Pc Set	Set	12/72



BPA FREE

MCPP-4

STAINLESS STEEL MEASURING CUP SET

◆ Set includes: 1/4 Cup, 1/3 Cup, 1/2 Cup, 1 Cup

ITEM	DESCRIPTION	UOM	CASE
MCP-4P	4-Pc Set	Set	12/48

STAINLESS STEEL MEASURING CUPS



MCP-4P

ALUMINUM QUART MEASURING CUPS

ITEM	DESCRIPTION	UOM	CASE
AM-05	1/2 Qt	Each	1/48
AM-1	1 Qt	Each	1/36
AM-2	2 Qt	Each	1/36
AM-4	4 Qt	Each	1/24

ALUMINUM MEASURING CUPS



AM-2



DELUXE POLYCARBONATE MEASURING CUPS

- ◆ One-piece and break-resistant
- ◆ Molded-in measurements for both quarts (red letters) and liters (blue letters)
- ◆ Tapered open handle for secure grip and allows nesting
- ◆ Dishwasher safe

ITEM	DESCRIPTION	UOM	CASE
PMCP-25	1 Cup	Each	6/72
PMCP-50	1 Pint	Each	6/72
PMCP-100	1 Qt	Each	6/36
PMCP-200	2 Qt	Each	6/36
PMCP-400	4 Qt	Each	6/24
PMCP-5SET	Complete 5-Pc Set	Set	1/6

POLYCARBONATE MEASURING CUPS



PMCP-SERIES 

POLYCARBONATE MEASURING CUPS

- ◆ Molded-in measure markings

ITEM	DESCRIPTION	UOM	CASE
PMU-25	1 Cup	Each	36
PMU-50	1 Pint	Each	36
PMU-100	1 Qt	Each	36
PMU-200	2 Qt	Each	36
PMU-400	4 Qt	Each	12



PMU-SERIES 



SPATULAS & TURNERS

- ◆ Stainless steel, satin finish blade
- ◆ Ergonomic handle with slip-free comfort grip reduces hand fatigue
- ◆ Dishwasher safe

High-quality
Low cost



HIGH-HEAT ORANGE NYLON ERGO HANDLE WOODEN HANDLE



DESCRIPTION	BLADE SIZE (LxW)	UOM	ITEM	CASE	ITEM	CASE
Mini Turner	2" x 2-1/4"	* Each			TN32	12/120
Sandwich Spreader	3-5/8" x 1-1/4"	Each			TN713	12/144
Small Scraper	4-1/2" x 3-1/8"	Each			TN526	12/72
Large Scraper	4-7/8" x 4"	Each			TN54	12/72
Steak/Burger Turner	4-1/8" x 3-3/4"	* Each			TN46	12/72
Turner	8" x 4"	Each	TNH-42	12/48	TN48	12/24
Grill Spatula	4-1/4" x 2-3/16"	* Each			TN165	12/72
Teppanyaki Turner, Full Tang	4" x 3-1/2"	* Each			TN43	12/72
Pie Server	4-5/8" x 2-3/8"	* Each			TN166	12/72
Fish Spatula	6-3/4" x 3-1/4"	Each	TNH-60	12/144	FST-6	12/144
Hamburger Turner	5-1/8" x 2-7/8"	* Each	TNH-61	12/72	TN719	12/72
Extra Heavy Turner, Cuffing Edge Blade	5" x 6"	* Each	TNH-63	12/48	TN56	12/48
Square Edge Turner	6-1/4" x 3"	* Each	TNH-64	12/72		
Square Edge Turner	7-1/4" x 3"	* Each	TNH-70	12/48		
Flexible Turner	8-1/4" x 2-7/8"	* Each	TNH-90	12/48	TN249	12/48
Flexible Turner (Perforated Blade)	8-1/4" x 2-7/8"	* Each	TNH-91	12/48	TN409	12/48
Offset Giant Turner	8-1/2" x 2-7/8"	* Each			TN44	12/48
Offset Spatula	3-1/2" x 3/4"	* Each			TOS-4	24/288
Offset Spatula	6-1/2" x 1-5/16"	* Each			TOS-7	12/144
Offset Spatula	8-1/2" x 1-1/2"	* Each			TOS-9	12/72
Bakery Spatula	4" x 3/4"	Each			TNS-4	24/288
Bakery Spatula	7-15/16" x 1-1/4"	Each			TNS-7	12/144
Bakery Spatula	10" x 1-3/8"	Each			TNS-9	12/72

*Measurement reflects blade size not including offset

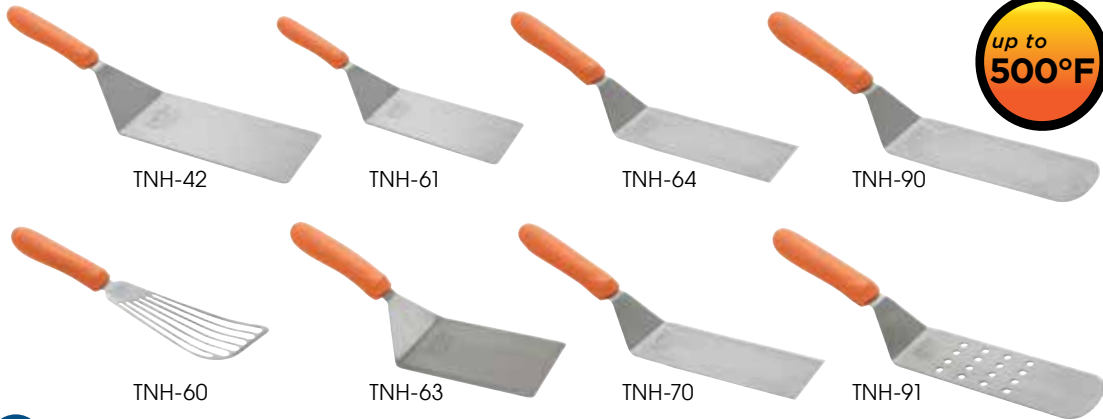

up to
500°F

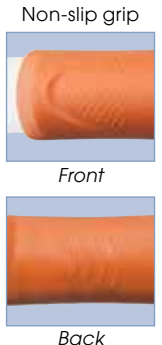

NSF[®] TNH-SERIES (ORANGE)

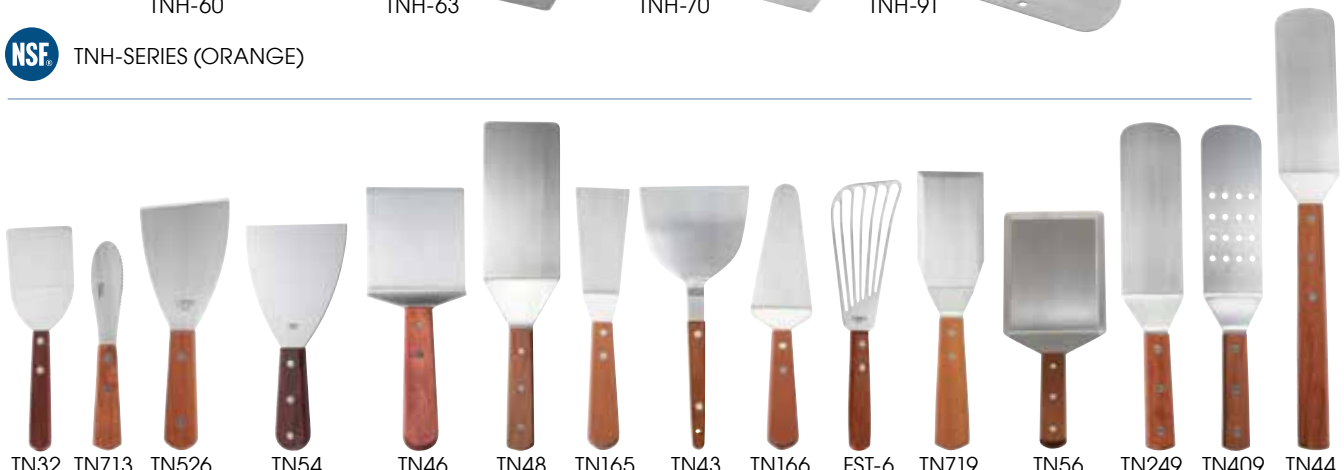

Relative size comparisons shown

- ◆ Stainless steel, satin finish blade
- ◆ Ergonomic handle with slip-free comfort grip reduces hand fatigue
- ◆ Dishwasher safe

SPATULAS & TURNERS



BLACK ERGO HANDLE



WHITE ERGO HANDLE

DESCRIPTION	BLADE SIZE (LXW)	UOM	BLACK ERGO HANDLE		WHITE ERGO HANDLE	
			ITEM	CASE	ITEM	CASE
Mini Turner	2" x 2-1/4"	* Each	TKP-30	12/120	TWP-30	12/120
Sandwich Spreader	3-5/8" x 1-1/4"	Each	TKP-31	12/144	TWP-31	12/144
Small Scraper	4-1/2" x 3-1/8"	Each	TKP-32	12/72	TWP-32	12/72
Large Scraper	4-7/8" x 4"	Each	TKP-40	12/72	TWP-40	12/72
Steak/Burger Turner	4-1/8" x 3-3/4"	* Each	TKP-41	12/72	TWP-41	12/72
Turner	8" x 4"	Each	TKP-42	12/48	TWP-42	12/48
Grill Spatula	4-1/4" x 2-3/16"	* Each	TKP-50	12/72	TWP-50	12/72
Pie Server	4-5/8" x 2-3/8"	* Each	TKP-51	12/72	TWP-51	12/72
Fish Spatula	6-3/4" x 3-1/4"	Each	TKP-60	12/144	TWP-60	12/144
Hamburger Turner	5-1/8" x 2-7/8"	* Each	TKP-61	12/72	TWP-61	12/72
Extra Heavy Turner, Cutting Edge Blade	5" x 6"	* Each	TKP-63	12/48		
Flexible Turner	8-1/4" x 2-7/8"	* Each	TKP-90	12/48	TWP-90	12/48
Flexible Turner (Perforated Blade)	8-1/4" x 2-7/8"	* Each	TKP-91	12/48	TWP-91	12/48
Offset Spatula	3-1/2" x 3/4"	* Each	TKPO-4	24/288	TWPO-4	24/288
Offset Spatula	6-1/2" x 1-5/16"	* Each	TKPO-7	12/144	TWPO-7	12/144
Offset Spatula	8-1/2" x 1-1/2"	* Each	TKPO-9	12/144	TWPO-9	12/72
Bakery Spatula	4" x 3/4"	Each	TKPS-4	24/288	TWPS-4	24/288
Bakery Spatula	7-15/16" x 1-1/4"	Each	TKPS-7	12/144	TWPS-7	12/144
Bakery Spatula	10" x 1-3/8"	Each	TKPS-9	12/144	TWPS-9	12/72

*Measurement reflects blade size not including offset



TKP-30



TKP-31



TKP-32



TKP-40



TKP-41



TKP-42



TKP-50



TKP-51



TKP-60



TKP-61



TKP-63

Refer to Allergen-Free Utensils for the purple handle collection



TKP-90



TKP-91



TKPO-9



TKPS-9



TKP-SERIES (BLACK) NSF

TWP-SERIES (WHITE) NSF

WINCO® SPREADER BULK PACK

Packed in a convenient display bucket for impulse purchase positioning.

- ◆ An assortment of 7 colors included in the convenient display bucket
- ◆ 3-5/8" spreader with stainless steel, satin finish blade
- ◆ Slip-free comfort grip

ITEM	DESCRIPTION	UOM	CASE
TWP-3135	35-Pcs/Pk	Pack	1/4

WINCO® SPREADER BULK PACK



Includes 7 handle colors TWP-3135 NSF

PASTA BASKETS



Electro-polished corrosion-resistant 18/8 stainless steel and extra-heavyweight construction stands up to high-volume use. Pasta baskets can be used with most pasta cooker machines and standard stock pots.

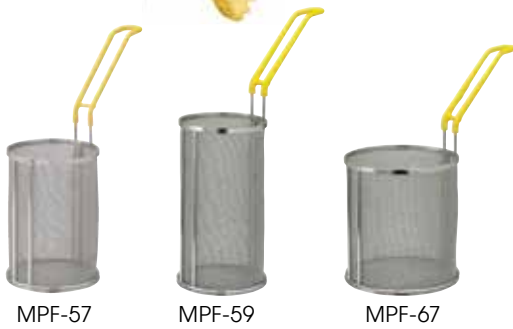

SUPER FINE MESH CONNOISSEUR PASTA BASKETS

- ◆ Designed specifically for fine pasta, such as capellini and linguine
- ◆ 18/8 stainless steel with reinforced frame

ITEM	DESCRIPTION	UOM	CASE
MPF-57	5"Dia x 7"H, Short	Each	1/8
MPF-59	5"Dia x 9"H, Tall	Each	1/8
MPF-67	6-1/2"Dia x 7"H, Wide	Each	1/8

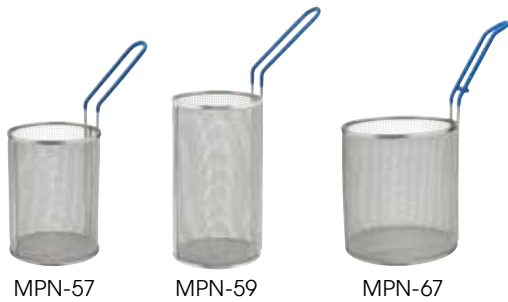

PASTA BOIL BASKETS

- ◆ 18/8 stainless steel frame and standard mesh
- ◆ Fits standard pasta cookers and stock pots

ITEM	DESCRIPTION	UOM	CASE
MPN-57	5-1/4" Dia x 7"H, Short	Each	2/8
MPN-59	5" Dia x 9"H, Tall	Each	2/8
MPN-67	6-1/2" Dia x 7"H, Wide	Each	2/6

BULK PASTA BASKET



MPN-1613

BULK PASTA/IMMERSION BASKET

- ◆ Durable 18/8 stainless steel
- ◆ Plastic coated handles rated for temperatures up to 250°F (120°C)
- ◆ Suitable for cooking most types of pasta in bulk
- ◆ Fits standard cookers

ITEM	DESCRIPTION	UOM	CASE
MPN-1613	16-1/4"L x 12-7/8"W x 10"H	Each	2



STRAINERS WITH HELPER HOOK



SSS-3



18/8 STAINLESS STEEL SPAGHETTI STRAINER

- ◆ Sturdy triple-riveted handle
- ◆ Helper hook rests over rim of pot / container

ITEM	DESCRIPTION	HANDLE	UOM	CASE
SSS-3	8-1/2"Dia	8"	Each	6/24



ASS-10

TAPERED ALUMINUM SPAGHETTI STRAINERS

- ◆ Helper hook rests over rim of pot / container

ITEM	DESCRIPTION	HANDLE	UOM	CASE
ASS-09	9"Dia	7-1/2"	Each	12
ASS-10	10"Dia	6-3/4"	Each	12

18/8 STAINLESS STEEL SCOOP COLANDER

- ◆ Long reach handle
- ◆ Deep, fully perforated scoop

ITEM	DESCRIPTION	UOM	CASE
CODS-7	7"L x 4"W, 11"L Hd	Each	4/16



SCOOP COLANDER



CODS-7

STAINLESS STEEL BOUILLON/CHINOIS STRAINERS

- ◆ Hollow handle
- ◆ Extra-fine mesh
- ◆ Filter purees, soups, sauces to a smooth consistency

ITEM	DESCRIPTION	UOM	CASE
CCB-8	8"	Each	1/6
CCB-8R	8", Reinforced	Each	1/6
CCB-10	10"	Each	6
CCB-10R	10", Reinforced	Each	6

Replaces former CCBH-Series

CONE MESH STRAINERS



CCB-8



CCB-8R

18/8 STAINLESS STEEL CHINA CAP STRAINERS

- ◆ Welded handle
- ◆ Coarse mesh
- ◆ Remove large particles from thicker liquids

ITEM	DESCRIPTION	UOM	CASE
CCS-8F	8" Fine	Each	12
CCS-10F	10" Fine	Each	12
CCS-12F	12" Fine	Each	12
CCS-8C	8" Coarse	Each	12
CCS-10C	10" Coarse	Each	12
CCS-12C	12" Coarse	Each	12



CCS-10C



CCS-10F

SOLID WOOD BOUILLON/CHINOIS PESTLE

- ◆ Press, crush and push mixtures through a bouillon strainer
- ◆ Fits standard size strainers

ITEM	DESCRIPTION	UOM	CASE
WPST-13	13-7/8"L x 3-1/8"Dia	Each	6/24

CHINOIS WOODEN PESTLE



WPST-13

SINGLE MESH DEEP STRAINER

ITEM	DESCRIPTION	DIA	UOM	CASE
MSH-5	Deep Bowl	5-1/2"	Each	12/48

DEEP MESH STRAINER



MSH-5

STAINLESS STEEL SKIMMERS

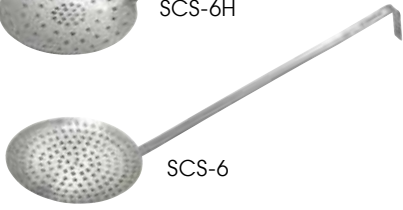

STAINLESS STEEL HEAVY-DUTY ONE-PIECE SKIMMER

ITEM	DESCRIPTION	HANDLE	UOM	CASE
SCS-6H	6-1/4"Dia	16"	Each	12/72

STAINLESS STEEL SKIMMERS

ITEM	DESCRIPTION	HANDLE	UOM	CASE
SCS-5	4-1/2"Dia	13"	Each	12/120
SCS-6	5-3/4"Dia	13-1/2"	Each	12/120

STAINLESS STEEL WIDE SKIMMER

ITEM	DESCRIPTION	UOM	CASE
SC-12	12"Dia	Each	12/24

WIRE SKIMMERS



NICKEL-PLATED WIRE SKIMMERS

ITEM	DESCRIPTION	HANDLE	UOM	CASE
SC-5R	5"Dia	13"	Each	12/36
SC-6R	6"Dia	13"	Each	12/36
SC-7R	7"Dia	13"	Each	12/36
SC-8R	8"Dia	13"	Each	12/24
SC-9R	9"Dia	13"	Each	12/24
SC-12R	12"Dia	13"	Each	12/24

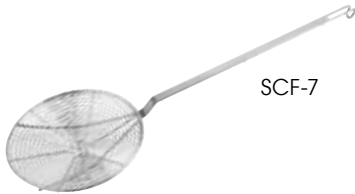

NICKEL-PLATED SPIRAL-WIRE SKIMMERS

ITEM	DESCRIPTION	HANDLE	UOM	CASE
SCF-7	7"Dia	14"	Each	12/48
SCF-9	9"Dia	14"	Each	12/48



NICKEL-PLATED MESH SKIMMERS

ITEM	DESCRIPTION	HANDLE	UOM	CASE
SCF-6R	6-1/2"Dia	13"	Each	12/48
SCF-6S	6-3/4" x 6-3/4"	13"	Each	12/48

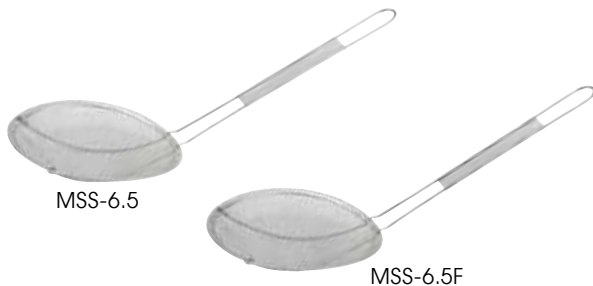

STAINLESS STEEL SINGLE MESH SKIMMERS

ITEM	DESCRIPTION	HANDLE	UOM	CASE
MSS-6F	6"Dia, Fine	13"	Each	12/120
MSS-6.5F	6-1/2"Dia, Fine	13"	Each	12/120
MSS-6	6"Dia, Coarse	13"	Each	12/120
MSS-6.5	6-1/2"Dia, Coarse	13"	Each	12/120

STAINLESS STEEL MESH STRAINERS

NEW

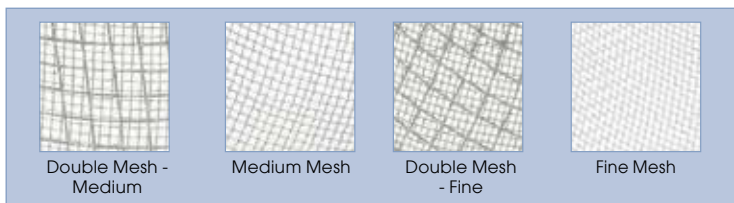

SINGLE MESH STRAINERS WITH PLASTIC HANDLE

ITEM	DESCRIPTION	DIA	UOM	CASE
MSTP-6SF	Fine Mesh	6-1/4"	Each	12/96
MSTP-6SM	Medium Mesh	6-1/4"	Each	12/96
MSTP-8SF	Fine Mesh	8"	Each	12/48
MSTP-8SM	Medium Mesh	8"	Each	12/48
MSTP-10SF	Fine Mesh	10-1/4"	Each	6/24
MSTP-10SM	Medium Mesh	10-1/4"	Each	6/24



DOUBLE MESH STRAINERS WITH PLASTIC HANDLE

ITEM	DESCRIPTION	DIA	UOM	CASE
MSTP-6DF	Fine Mesh	6-1/4"	Each	12/96
MSTP-6DM	Medium Mesh,	6-1/4"	Each	12/96
MSTP-8DF	Fine Mesh	8"	Each	12/48
MSTP-8DM	Medium Mesh,	8"	Each	12/48
MSTP-10DF	Fine Mesh	10-1/4"	Each	6/24
MSTP-10DM	Medium Mesh	10-1/4"	Each	6/24



TINNED REINFORCED DOUBLE MESH

ITEM	DESCRIPTION	DIA	UOM	CASE
MST-10RB	Flat Handle	10-1/2"	Each	12
MST-1010D	Round Handle	10-1/2"	Each	12
MST-12D	Round Handle	12"	Each	6
MST-14D	Round Handle	14"	Each	6



STAINLESS STEEL FINE MESH STRAINERS

ITEM	DESCRIPTION	DIA	UOM	CASE
MS3A-8D	Double Mesh	8"	Each	12/48
MS3A-8S	Single Mesh	8"	Each	12/48
MS2K-10D	Double Mesh	10-1/2"	Each	12/48
MS2K-10S	Single Mesh	10-1/2"	Each	12/48



TINNED DOUBLE MESH STAINERS

ITEM	DESCRIPTION	DIA	UOM	CASE
MSTF-6D	Fine	6-1/4"	Each	12/96
MSTF-8D	Fine	8"	Each	12/48
MSTF-10D	Fine	10-1/4"	Each	12/24
MST-6D	Medium	6-1/4"	Each	12/96
MST-8D	Medium	8"	Each	12/48
MST-10D	Medium	10-1/2"	Each	12/24



TINNED SINGLE MESH STRAINERS

ITEM	DESCRIPTION	DIA	UOM	CASE
MSTF-6S	Fine	6-1/4"	Each	12/96
MSTF-8S	Fine	8"	Each	12/48
MSTF-10S	Fine	10-1/4"	Each	12/24
MST-6S	Medium	6-1/4"	Each	12/96
MST-8S	Medium	8"	Each	12/48
MST-10S	Medium	10-1/4"	Each	12/24



CULINARY BASKETS



MSB-10



Coarse



MSB-10M



Medium



MSB-10F



Fine

NICKEL-PLATED STEEL CULINARY BASKETS

◆ Wire reinforced base and sturdy handle

ITEM	DESCRIPTION	DIA	UOM	CASE
MSB-08	Coarse Mesh	8"	Each	12/36
MSB-08M	Medium Mesh	8"	Each	12/36
MSB-08F	Fine Mesh	8"	Each	12/36
MSB-10	Coarse Mesh	10"	Each	12/36
MSB-10M	Medium Mesh	10"	Each	12/36
MSB-10F	Fine Mesh	10"	Each	12/36
MSB-12	Coarse Mesh	12"	Each	30
MSB-12M	Medium Mesh	12"	Each	30
MSB-12F	Fine Mesh	12"	Each	30

BREADING BASKETS



MSBW-10



Coarse



MSBW-10M



Medium

WHITE EPOXY-COATED STEEL BREADING BASKETS

◆ Epoxy-coating prevents batter/breading from sticking to the basket

ITEM	DESCRIPTION	DIA	UOM	CASE
MSBW-08	Coarse Mesh	8"	Each	12/36
MSBW-08M	Medium Mesh	8"	Each	12/36
MSBW-10	Coarse Mesh	10"	Each	12/36
MSBW-10M	Medium Mesh	10"	Each	12/36
MSBW-12	Coarse Mesh	12"	Each	12/36
MSBW-12M	Medium Mesh	12"	Each	12/36

FUNNELS



PF-32

PLASTIC FUNNELS

ITEM	DESCRIPTION	SIZE	UOM	CASE
PF-8	8 Oz	4"Dia	Each	6/324
PF-16	16 Oz	5-1/4"Dia	Each	6/324
PF-32	32 Oz	6-1/4"Dia	Each	6/216



SF-6



SF-6S

STAINLESS STEEL FUNNELS & STRAINER

◆ Mirror finish

ITEM	DESCRIPTION	UOM	CASE
SF-5	5" Funnel	Each	12/72
SF-6	5-3/4" Funnel	Each	12/72
SF-6S	Strainer for SF-5 and SF-6	Each	120/480

PLASTIC BASTER

◆ 1-1/2 oz capacity with rubber bulb

ITEM	DESCRIPTION	UOM	CASE
PBST-1.5	7-1/2" Tube, 11" O.L.	Each	12/72

DISPENSERS



PBST-1.5

OIL CAN WITH BRASS COVER

ITEM	DESCRIPTION	UOM	CASE
OC-24	24 Oz	Each	1/12



OC-24

SYRUP DISPENSERS

◆ The stainless steel slide on lid prevents dripping

ITEM	DESCRIPTION	UOM	CASE
PSUD-32	32 Oz	Each	12
PSUD-48	48 Oz	Each	12
PSUD-WLid	Lid, White	Each	24/144
PSUD-RLid	Lid, Red	Each	24/144
PSUD-TLid	Lid, Tan	Each	24/144



PSUD-RLID

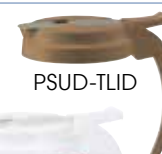

PSUD-TLID



PSUD-32



PSUD-48

BPA FREE

WIDE-MOUTH SQUEEZE BOTTLES

- ◆ Open tip ready to use - no need for cutting
- ◆ Wide mouth for easier refilling and cleaning
- ◆ Leak-free design

ITEM	DESCRIPTION	UOM	CASE
PSW-12	12 Oz, Clear	Pack	1/12
PSW-12R	12 Oz, Red	Pack	1/12
PSW-12Y	12 Oz, Yellow	Pack	1/12
PSW-16	16 Oz, Clear	Pack	1/8
PSW-16R	16 Oz, Red	Pack	1/8
PSW-16Y	16 Oz, Yellow	Pack	1/8
PSW-24	24 Oz, Clear	Pack	1/8
PSW-24R	24 Oz, Red	Pack	1/8
PSW-24Y	24 Oz, Yellow	Pack	1/8
PSW-32	32 Oz, Clear	Pack	1/6
PSW-32R	32 Oz, Red	Pack	1/6
PSW-32Y	32 Oz, Yellow	Pack	1/6
PSW-C-LID	Replacement Lid, Clear	Doz	60
PSW-Y-LID	Replacement Lid ,Yellow	Doz	60
PSW-CAP	Cap, Red, 48pcs/pk	Pack	480

SQUEEZE BOTTLES



PSW-24

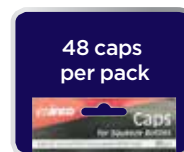

PSW-CAP

Fits both PSW- and PSB-Series lids

PSW-SERIES

BPA FREE



6 bottles per pack



PSB-SERIES

BPA FREE

SQUEEZE BOTTLES

◆ Open tip ready to use - no need for cutting

ITEM	DESCRIPTION	UOM	CASE
PSB-08C	8 Oz, Clear	Pack	1/12
PSB-08R	8 Oz, Red	Pack	1/12
PSB-08Y	8 Oz, Yellow	Pack	1/12
PSB-12C	12 Oz, Clear	Pack	1/12
PSB-12R	12 Oz, Red	Pack	1/12
PSB-12Y	12 Oz, Yellow	Pack	1/12
PSB-24C	24 Oz, Clear	Pack	1/6
PSB-24R	24 Oz, Red	Pack	1/6
PSB-24Y	24 Oz, Yellow	Pack	1/6
PSB-C-LID	Replacement Lid, Clear	Doz	60
PSW-CAP	Cap, Red, 48pcs/pk	Pack	480

SCOOPS



IS-4

STAINLESS STEEL ICE SCOOP

ITEM	DESCRIPTION	UOM	CASE
IS-4	4 Oz Ice Scoop	Each	12/144



SSC-3

STAINLESS STEEL LARGE UTILITY SCOOPS

ITEM	DESCRIPTION	UOM	CASE
SSC-2	1 Qt (32 Oz) Utility Scoop	Each	6/24
SSC-3	2 Qt (64 Oz) Large Utility Scoop	Each	6/18

Improved



AS-85



Built-in low-profile feet



ALUMINUM SCOOPS - NOW WITH STABILIZING FEET

- ◆ Built-in low-profile feet hold scoop upright when placed on solid surfaces
- ◆ Hand wash only

ITEM	DESCRIPTION	UOM	CASE
AS-5	5 Oz	Each	12/60
AS-12	12 Oz	Each	12/60
AS-24	24 Oz	Each	12/60
AS-38	38 Oz	Each	12/48
AS-58	58 Oz	Each	12/36
AS-85	85 Oz	Each	12/24



ASFB-SERIES

ALUMINUM FLAT BOTTOM SCOOPS

- ◆ Hand wash only

ITEM	DESCRIPTION	UOM	CASE
ASFB-4	4 Oz	Each	12/72
ASFB-7	7 Oz	Each	12/72
ASFB-16	16 Oz	Each	12/72
ASFB-24	24 Oz	Each	12/48



PS-20

PS-50

CLEAR PLASTIC FLAT BOTTOM SCOOPS

ITEM	DESCRIPTION	UOM	CASE
PS-5	5 Oz	Each	24/144
PS-10	10 Oz	Each	24/144
PS-20	20 Oz	Each	24/144
PS-32	32 Oz	Each	12/72
PS-50	50 Oz	Each	12/72



PS-SERIES
(5 TO 50 OZ)



PS-64

WHITE PLASTIC FLAT BOTTOM SCOOP

ITEM	DESCRIPTION	UOM	CASE
PS-64	64 Oz, White	Each	12/48

SCOOP HOLDERS



WHW-4



WHW-7



Scoops sold separately

EPOXY-COATED WIRE SCOOP HOLDERS

- ◆ Mount to the wall for easy reach and sanitation
- ◆ Keeps scoops off food prep surfaces
- ◆ Plastic coated wire

ITEM	DESCRIPTION	SIZE (L X W)	UOM	CASE
WHW-4	Holds AS-12, AS-24, PS-10 & PS-20	4-1/4" x 5-3/8"	Each	12/48
WHW-7	Holds AS-38, AS-58, PS-32, PS-50 & PS-64	7" x 8"	Each	12/48

BAR MAID® PLASTIC FLAT BOTTOM SCOOPS

ITEM	DESCRIPTION	UOM	CASE
CR-838W	32 oz	Each	1/84
CR-835W-N	82 oz, NSF	Each	1/36

BAR MAID® PLASTIC ROUND BOWL SCOOPS

ITEM	DESCRIPTION	UOM	CASE
CR-854W	4oz	Each	1/144
CR-846W	6oz	Each	1/144
CR-849W	8oz	Each	1/400
CR-840W	16 oz	Each	1/144

BAR MAID® EPOXY-COATED WIRE SCOOP HOLDERS

ITEM	DESCRIPTION	UOM	CASE
CR-850M	Holds 16 oz Scoops	Each	48
CR-850L	Holds 32 oz & 82 oz Scoops	Each	48

SCOOPS



CR-838W



CR-840W



CR-850L

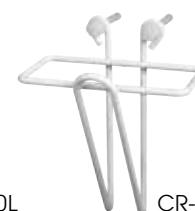

CR-850M



ERGONOMIC KITCHEN TOOLS

- ◆ Comfortable non-slip soft-grip handle
- ◆ Dishwasher safe

ITEM	DESCRIPTION	UOM	CASE
VP-300	Straight Edge "Y" Peeler	Each	12/72
VP-301	Serrated Edge "Y" Peeler	Each	12/72
VP-302	Julienne Peeler	Each	12/72
VP-303	Straight Peeler	Each	12/72
VP-304	Serrated Edge Peeler	Each	12/72
VP-305	Apple Corer	Each	12/72
VP-306	Zester/Lemon Peeler	Each	12/72
VP-307	Melon Baller	Each	12/72
VP-308	Tomato Stem Corer	Each	12/72
VP-309	Cheese Plane	Each	12/72
VP-310	Butter Curler	Each	12/72
VP-314	2-7/8" Oyster/Clam Knife	Each	12/72
VP-311	Grater w/1.5mm Dia Holes	Each	12/72
VP-312	Grater w/3mm Dia Holes	Each	12/72
VP-313	Grater w/6mm Dia Holes	Each	12/72
VP-315	Small Pizza Cutter 2-1/2" Wheel Blade	Each	12/72
VP-316	Large Pizza Cutter 4" Wheel Blade	Each	12/72

ERGONOMIC KITCHEN TOOLS



VP-300 NSF



VP-301 NSF



VP-302 NSF



VP-303 NSF



VP-304 NSF



VP-305 NSF



VP-306 NSF



VP-307 NSF



VP-308 NSF



VP-309 NSF



VP-310 NSF



VP-314 NSF



VP-311 NSF



VP-312 NSF



VP-313 NSF



VP-315



VP-316

GRATERS & SLICERS

PRTS-2



PLASTIC CHEESE GRATER

- ◆ Ideal for grating hard cheese or chocolate
- ◆ 2 interchangeable drums for fine & coarse grating
- ◆ Dishwasher safe

ITEM	DESCRIPTION	UOM	CASE
PRTS-2	7"L x 3-1/2"W x 4-3/8"H	Each	6/24



GT-103



GT-104



GT-105



GT-106



GT-204



GT-345



18/8 STAINLESS STEEL GRATERS WITH COVER

- ◆ Sharp etched blade & comfortable grip
- ◆ Non-corrosive, durable, reliable
- ◆ GT-204 & GT-345: Anti-slip feet
- ◆ GT-345: two blades in one - zester & fine
- ◆ Dishwasher safe

ITEM	DESCRIPTION	UOM	CASE
GT-103	Medium Coarse Blade	Each	12/72
GT-104	Zester Blade	Each	12/72
GT-105	Fine Blade	Each	12/72
GT-106	Ribbon Blade	Each	12/72
GT-204	Zester Blade & Anti-Slip Feet	Each	12/72
GT-345	Half Zester / Half Fine Blade & Anti-Slip Feet	Each	12/72

Micro-etched blades



Medium Coarse



Zester



Fine



Ribbon



GT-401



SQG-1



SQG-4



5-SIDE STAINLESS STEEL GRATER

- ◆ Ergonomic soft-grip handle
- ◆ Anti-slip foot securely grips surface
- ◆ Zester / Fine / Slicer / Medium Coarse / Ribbon

ITEM	DESCRIPTION	UOM	CASE
GT-401	5-Sided Grater	Each	12/48

4-SIDE STAINLESS STEEL BOX GRATERS

ITEM	DESCRIPTION	SIZE	UOM	CASE
SQG-1	Tapered Grater	4" x 3" x 9"	Each	12/72
SQG-4	Box Grater	4" x 4" x 9"	Each	12/24



ACS-4



Adjustable cutting thickness



ADJUSTABLE CHEESE SLICER

- ◆ 4" wide aluminum roller adjusts for thick or thin slicing
- ◆ 18/8 stainless steel wire is removable

ITEM	DESCRIPTION	UOM	CASE
ACS-4	Zinc Alloy Cheese Slicer, S/S Wire, Adjustable Alu Roller	Each	12/36



CS-44P



CS-44W



18/8 STAINLESS STEEL WIRE SLICERS

- ◆ Provides a smooth cut
- ◆ 44" long wire secured to handles at each end
- ◆ Customize slicing thickness and angle

ITEM	DESCRIPTION	UOM	CASE
CS-44P	Polyethylene Hdl	Each	24/144
CS-44W	Wooden Hdl	Each	24/144

PRODUCE PREP

HEAVY DUTY STAINLESS STEEL PINEAPPLE CORER

- ◆ Cores and rings pineapple with a simple twist, extracting fruit without eyes or peels
- ◆ Includes protective storage cap

ITEM	DESCRIPTION	UOM	CASE
SPC-3	Pineapple Corer	Each	6/24



STAINLESS STEEL CHERRY PITTER

- ◆ Quickly and easily remove cherry or olive pits
- ◆ Dishwasher safe

ITEM	DESCRIPTION	UOM	CASE
SCC-5	5-1/4" O.L.	Each	12/144



ALUMINUM HAND-PRESS APPLE SLICER

- ◆ Wedge and core with a single press

ITEM	DESCRIPTION	UOM	CASE
AAD-12	4-3/8"Dia	Each	12/48



TOMATO STEM CORERS

ITEM	DESCRIPTION	UOM	CASE
TSC-2	Stainless Steel	Doz	24/144
TSC-2-2R	2-Pcs/Pk, Retail Pkg	Pack	72/144

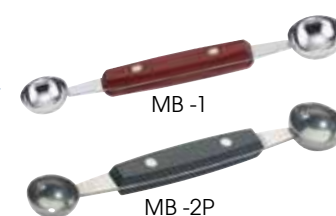

MELON BALLERS

- ◆ Full tang riveted handles

ITEM	DESCRIPTION	UOM	CASE
MB-1	2-Sided, Wooden Hdl	Each	24/240
MB-2P	2-Sided, PP Hdl	Each	24/240

STAINLESS STEEL GRAPEFRUIT SPOON

- ◆ Serrated edge easily cuts into citrus fruits

ITEM	DESCRIPTION	UOM	CASE
SRS-6	6-1/4" O.L.	Doz	1/25



HANDHELD CITRUS SQUEEZERS

Extract all the juice without the rind, pulp or seeds.

- ◆ Aluminum with baked-on enamel coating
- ◆ Dishwasher safe

ITEM	DESCRIPTION	UOM	CASE
LS-8G	2-1/2"Dia	Each	6/48
LS-9O	3-1/2"Dia	Each	9/36
LS-9Y	3"Dia	Each	6/48



STAINLESS STEEL MANUAL JUICE SQUEEZER

ITEM	DESCRIPTION	UOM	CASE
JC-4	5"Dia	Each	24

PLASTIC LETTUCE KNIFE

- ◆ Prevents oxidation and prevents lettuce discoloring
- ◆ Non-stick friendly; dishwasher safe

ITEM	DESCRIPTION	UOM	CASE
PLK-11G	11-1/2"L	Each	24/144



VEGETABLE PEELERS

ITEM	DESCRIPTION	UOM	CASE
VP-1	Nickel Plated Handle	Doz	2/24
VP-2	Plastic Handle	Doz	2/24



KITCHEN SHEARS



KS-01



KS-06



KS-06 built-in cracker and bottle cap opener



ALL PURPOSE KITCHEN SHEARS

ITEM	DESCRIPTION	UOM	CASE
KS-01	All purpose	Each	12/120
KS-06	All purpose, Detachable	Each	12/72



Built-in cracker or bottle cap grip



Built-in bottle cap opener



KS-06 is detachable



KS-02



KS-03



POULTRY SHEARS

- ◆ Lock to keep shears closed for safe storage

ITEM	DESCRIPTION	UOM	CASE
KS-02	Stainless Steel, Soft PP Hdl	Each	12/72
KS-03	Stainless Steel	Each	10/50



KS-05



Cut, chop, mince herbs



HERB SHEARS

- ◆ 5 stainless steel blades
- ◆ Ideal for cutting, chopping and mincing herbs
- ◆ Comfortable PP and TPR handles for easy grip

ITEM	DESCRIPTION	UOM	CASE
KS-05	5-Layer Blade	Each	12/72

SPECIALTY UTENSILS

Twist & Out™



TWIST & OUT™ CHROME-PLATED CAN OPENERS

- ◆ Soft-grip handle helps to reduce hand fatigue while providing leverage when turning the crank
- ◆ Smooth-cutting blade makes all day prep easier
- ◆ Durable frame handles size 10 cans with ease

ITEM	DESCRIPTION	UOM	CASE
CO-901	7"L, Easy-Turn Handle	Each	12/48
CO-902	8-3/4"L, Crank Handle	Each	12/48



Front gears

Back handle

CO-902

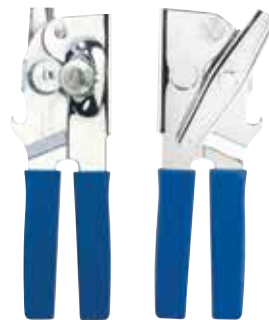

Front gears

Back handle

CO-901



Twist & Out™ hanging packaging



LC-04

STAINLESS STEEL NUT CRACKER

ITEM	DESCRIPTION	UOM	CASE
LC-04	4-3/4"	Each	24/144

EMPANADA FORK PASTRY PRESSES

Ideal for high-volume prep, this patented design significantly speeds up production and saves on time and labor costs.

- ◆ Time and labor-saving
- ◆ Sturdy, long-lasting stainless steel
- ◆ 3.25" x 5" or 7" press area
- ◆ Anti-slip handle with finger grooves for comfortable grip
- ◆ Ideal for empanadas, turnovers, mini calzones, and more

ITEM	DESCRIPTION	UOM	CASE
EF-05	5"L Empanada Fork	Each	1/72
EF-07	7"L Empanada Fork	Each	48

SPECIALTY UTENSILS



EF-07



EF-05

ALL-IN-ONE ALUMINUM ALLOY GARLIC PRESS & SLICER

- ◆ Rust-resistant with a non-stick coating
- ◆ Simplify cleaning with tool attached to inside of handle
- ◆ Solid, sturdy, comfortable-to-squeeze handles

ITEM	DESCRIPTION	UOM	CASE
GP-2	Garlic Press, Non-Stick	Each	1/72



GP-1

GP-2

ALUMINUM ALLOY GARLIC PRESS

ITEM	DESCRIPTION	UOM	CASE
GP-1	Garlic Press	Each	12/96

STAINLESS STEEL SERRATOR

ITEM	DESCRIPTION	UOM	CASE
SRT-7	7" S/S, Wooden Handle Grip	Each	12/72



SRT-7

WIRE EGG SLICERS

- ◆ Multiple slicing with one press; aluminum body
- ◆ Stainless steel wires are securely clamped into the casing

ITEM	DESCRIPTION	UOM	CASE
AES-1	Round	Each	12/144
AES-4	Square	Each	1/96



AES-4

AES-1

STAINLESS STEEL EGG SEPARATOR

- ◆ 8-1/2" easy-grip hollow handle
- ◆ Great for preparing crème brûlée, pudding, tiramisu & soufflé
- ◆ Dishwasher safe

ITEM	DESCRIPTION	UOM	CASE
SES-3	2-7/8"Dia	Each	24/96



SES-3

OVAL STAINLESS STEEL SKEWERS

- ◆ Flat needle keeps food from turning while cooking/grilling

ITEM	DESCRIPTION	UOM	CASE
SKO-8	8"	Doz	5/100
SKO-10	10"	Doz	5/60
SKO-12	12"	Doz	5/60



SKO-SERIES

BAMBOO SKEWERS

- ◆ 100 pieces per bag

ITEM	DESCRIPTION	UOM	CASE
WSK-06	6"	Bag	30/240
WSK-08	8"	Bag	30/240
WSK-10	10"	Bag	30/120
WSK-12	12"	Bag	30/120



WSK-10

MEAT PREP TOOLS



MT-4

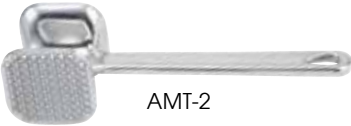

AMT-2



AMT-3



AMT-4

Soften for tender meat,
Flatten for faster cooking

ALUMINUM MEAT TENDERIZERS

ITEM	DESCRIPTION	HEAD SIZE	O.L.	UOM	CASE
MT-4	2-Sided Cast Alu, Wooden Handle	3" x 2-1/2"	13"	Each	12/24
AMT-2	2-Sided Cast Alu	3" x 3"	10-1/2"	Each	1/36
AMT-3	3-Sided Zinc Alloy	3" x 2-3/8"	11"	Each	1/20
AMT-4	2-Sided, Heavy Cast Alu	4-1/4" x 2-3/4"	12-3/4"	Each	1/12



SWS-6



ONE-PIECE 18/8 STAINLESS STEEL SMASHED BURGER PRESS WITH SILICONE SLEEVE

- ◆ Unique one-piece design
- ◆ Silicone sleeve is heat-resistant up to 450°F (230°C)

ITEM	DESCRIPTION	SIZE	UOM	CASE
SWS-6	1.67 lbs, Red	6" Dia	Each	1/12



SWS-74



SWS-94

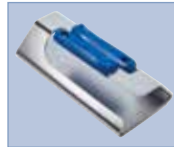

Nested together for additional weight



ONE-PIECE 18/8 STAINLESS STEEL STEAK WEIGHTS WITH SILICONE SLEEVE

- ◆ Unique one-piece design
- ◆ Stack/nest together for heavier weight
- ◆ Silicone sleeve is heat-resistant up to 450°F (230°C)

ITEM	DESCRIPTION	SIZE	UOM	CASE
SWS-74	2 Lb, Red	7-1/2" x 4"	Each	1/12
SWS-94	3 Lb, Blue	9-3/4" x 4-3/4"	Each	1/8



SWS-SERIES

STEAK WEIGHTS

ITEM	DESCRIPTION	SIZE	UOM	CASE
SWA-1	1 Lb Cast Alu	4-1/4" x 8-1/4"	Each	1/12
SWA-5	1 Lb Cast Alu	5-1/4" x 9"	Each	1/12
SWA-2	2 Lbs Cast Iron	4-1/4" x 8-1/4"	Each	6
SWA-9	2.5 Lbs Cast Iron	5-1/4" x 9"	Each	6



SWA-5



SWA-2

HAMBURGER PRESS

- ◆ Adjustable patty thickness

ITEM	DESCRIPTION	UOM	CASE
HP-4	4-1/2"Dia	Each	12/36

HP-4



- ◆ Rare
- ◆ M-Rare
- ◆ Medium
- ◆ M-Well
- ◆ Well



PSM-SERIES



STEAK MARKERS

- ◆ Thin 2.0mm nonmarring picks identify done-ness
- ◆ 1,000 pieces per bag

ITEM	DESCRIPTION	COLOR	UOM	CASE
PSM-R	Rare	Red	Bag	1/5
PSM-MR	Medium Rare	Pink	Bag	1/5
PSM-M	Medium	White	Bag	1/5
PSM-MW	Medium-Well	Yellow	Bag	1/5
PSM-W	Well Done	Tan	Bag	1/5



SEAFOOD PREPARATION

STAINLESS STEEL FISH BONE TWEEZERS

- ◆ Ideal for removing fish pin bones
- ◆ Dishwasher safe

ITEM	DESCRIPTION	UOM	CASE
TTG5-2PK	2-Pcs/Pk	Pack	12/144

2 pieces per pack



TTG5-2PK

ALUMINUM SHRIMP DEVEINER

- ◆ Devein and peel shrimp with one tool

ITEM	DESCRIPTION	UOM	CASE
SDA-7	2-Pcs/Pk	Pack	12/144



SDA-7

STAINLESS STEEL FISH SCALER

ITEM	DESCRIPTION	UOM	CASE
FSP-9	9-1/2"L	Each	60/240



FSP-9 NSF

LOBSTER CRACKERS

ITEM	DESCRIPTION	SIZE	UOM	CASE
LC-01	Stainless Steel	6"	Each	12/72
LC-03	Chrome Plated, Large	6"	Each	12/144
LC-04	Nut / Lobster Cracker	4-3/4"	Each	24/144
LC-05	Zinc Alloy	6"	Each	12/72
LC-85	Zinc Alloy, Carded	6"	Each	12/72



LC-85



LC-01



LC-03



LC-04



LC-05

18/8 STAINLESS STEEL SEAFOOD PICKS

- ◆ Narrow two-tine fork designed to effortlessly reach more shellfish meat
- ◆ 4 pieces per pack

ITEM	DESCRIPTION	UOM	CASE
LC-08	8"L x 3/4"W	Pack	30/120



LC-08

OYSTER/CLAM KNIVES

ITEM	DESCRIPTION	SIZE	UOM	CASE
VP-314	2-7/8" Blade, Soft Rubber Grip NSF	7-5/8" O.L.	Each	12/72
KCL-5P	3" Blade, Plastic Handle, NSF	6-3/4" O.L.	Each	12/72
KCL-1	2-3/4" Blade, Wooden Handle	5-7/8" O.L.	Each	12/72
KCL-2	2-7/8" Blade, Wooden Handle	6-5/8" O.L.	Each	12/72
KCL-3	3-1/2" Blade, Wooden Handle	7-1/2" O.L.	Each	12/72

OYSTER/CLAM KNIVES



VP-314 NSF



KCL-5P NSF



KCL-3



KCL-2



KCL-1

STAINLESS STEEL MESH GLOVES

Rust resistant 304L stainless steel made for meat processing. Reversible/ambidextrous with snap-and-cinch wrist strap.

- ◆ Light-weight and non-corrosive
- ◆ Reversible

ITEM	DESCRIPTION	SIZE	UOM	CASE
PMG-1S	White Strap	Small	Each	10/50
PMG-1M	Red Strap	Medium	Each	10/50
PMG-1L	Blue Strap	Large	Each	50

PROTECTIVE GLOVES



Closure Detail



Mesh Detail



PMG-1L

GRILL TOOLS



The only cutlery endorsed by American Master Chefs' Order



ACERO FORGED COOK'S FORKS

◆ Extra heavyweight with triple-riveted POM handle

ITEM	DESCRIPTION	PRONGS	UOM	CASE
KFP-62	Curved, 12" w/Hdl	6"L	Each	6/36
KFP-71	Straight, 12" w/Hdl	6"L	Each	6/36
KFP-121	Curved, 12" w/Hdl	4"L	Each	6/36
KFP-140	Curved, 14" w/Hdl	5"L	Each	6/36
KFP-180	Curved, 18" w/Hdl	5"L	Each	6/36



KFP-71 | STRAIGHT



KFP-62



KFP-140



KFP-121



KFP-180

POT FORKS

ITEM	DESCRIPTION	UOM	CASE
KPF-612	12-5/8" O.L.	Each	12/120
KPF-210	21-7/8" O.L.	Each	12/72



KPF-612



KPF-210



PANCAKE TURNER

◆ Heat resistant up to 608°F (320°C)
◆ Non-stick friendly nylon blade, stainless steel handle

ITEM	DESCRIPTION	UOM	CASE
STN-3	15-7/16" O.L.	Each	24/48



STN-3



STN-6



STN-8



APP-20

STAINLESS STEEL SERVING TURNERS

ITEM	DESCRIPTION	UOM	CASE
STN-6	14" O.L., Solid	Each	12/120
STN-8	14" O.L., Slotted	Each	12/120

ALUMINUM PIZZA/BURGER PEEL

◆ 14 gauge, 1.6mm thick
◆ 11" handle, 20" overall length

ITEM	DESCRIPTION	UOM	CASE
APP-20	9" x 6-3/4" Blade	Each	12/48

STAINLESS STEEL EGG RINGS

◆ Achieve consistent results
◆ 1" high round or square ring with angled handle

ITEM	DESCRIPTION	UOM	CASE
EGR-3	3" Dia	Each	12/144
EGR-4	4" Dia	Each	12/144
EGR-5	5" Dia	Each	12/144
EGR-6	6" Dia	Each	12/96
EGRS-44	4" x 4"	Each	12/144



EGR-6



EGRS-44

ALUMINUM BASTING COVERS

- ◆ Contain mess and splatter from frying food on the grill
- ◆ Cover entrée to keep it warm until ready to serve
- ◆ Plastic knob handle

ITEM	DESCRIPTION	UOM	CASE
ADBC-7	7"Dia	Each	6/12
ADBC-8	8"Dia	Each	6/12
ADBC-9	9"Dia	Each	6/12
ADBC-10	10"Dia	Each	6/12

GRILL BASTING COVERS



ALUMINUM DOME BASTING COVER

- ◆ Cover hamburgers while grilling to hold in steam for thorough and even cooking
- ◆ Plastic knob handle

ITEM	DESCRIPTION	UOM	CASE
AHC-6	6"Dia	Each	12/48

WINCO® PRIME FRENCH FRY SCOOPS

- ◆ 18/8 stainless steel with 4" long plastic handles
- ◆ Removable handles for easy cleaning

ITEM	DESCRIPTION	UOM	CASE
FFBN-1R	Right Handle, NSF	Each	12/36
FFBN-2	Dual Handles, NSF	Each	12/36



FRYER ACCESSORIES



FRENCH FRY SCOOPS

- ◆ Stainless steel with 4" long plastic handles
- ◆ Removable handles for easy cleaning

ITEM	DESCRIPTION	UOM	CASE
FFB-1R	Right Handle	Each	12/36
FFB-2	Dual Handles	Each	12/36



FRYER OIL CONE FILTERS AND WIRE STAND

- ◆ Cloth filters are heat resistant up to 392°F (200°C)

ITEM	DESCRIPTION	UOM	CASE
FF-10	10" Filter Stand	Each	20
FF-RC	Filter Cones, Cloth, 10-Pcs/ Box	Box	1/60



CHROME-PLATED FRYER SCREEN

- ◆ For use with: Imperial: IFS-40; DCS: FRFG-40; American Range: AF-45; PITCO: 35C and 45C

ITEM	DESCRIPTION	UOM	CASE
FS-1313	13" x 13"	Each	12/48

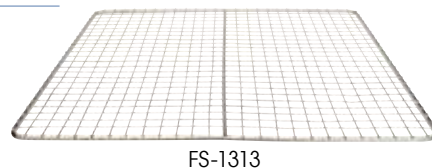

STAINLESS STEEL FRYER CLEANOUT ROD

- ◆ Clean out clogged fryer drains

ITEM	DESCRIPTION	UOM	CASE
SFCR-30	30"L	Each	24/144



STAINLESS STEEL UNIVERSAL FRYER CONNECTOR STRIP

- ◆ Prevent debris falling between a bank of fryers

ITEM	DESCRIPTION	UOM	CASE
SFCS-21	21-5/8"L, for 3 or 4 Tube Fryers	Each	12/24
SFCS-25	25-5/8"L, for 5 Tube Fryers	Each	12/24



BACK OF HOUSE

Clean & Organize



CARPET ENTRYWAY FLOOR MATS

- ◆ Vinyl backing prevents curling/ripping and stays flat
- ◆ Carts roll easily over the tapered rubber edge

ITEM	DESCRIPTION	COLOR	UOM	CASE
FMC-310C	3' x 10'	Charcoal	Each	1
FMC-310U	3' x 10'	Burgundy	Each	1
FMC-35C	3' x 5'	Charcoal	Each	1
FMC-35U	3' x 5'	Burgundy	Each	1
FMC-46C	4' x 6'	Charcoal	Each	1
FMC-46U	4' x 6'	Burgundy	Each	1



Lays flat & does not curl/rip with constant foot traffic



Tapered, weighted, durable edge

ENTRYWAY FLOOR MATS

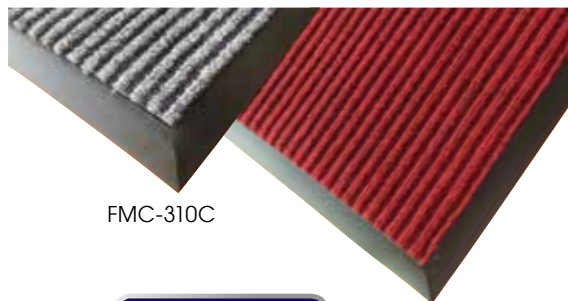

FMC-310C

FMC-310U

Tapered, weighted, durable

ANTI-FATIGUE RUBBERIZED GEL FOAM FLOOR MAT

- ◆ Ideal for standing-in-place jobs
- ◆ Beveled edges reduce tripping
- ◆ Comfortable and supportive closed-cell foam
- ◆ Grease-resistant and waterproof
- ◆ 1/2" thick

ITEM	DESCRIPTION	COLOR	UOM	CASE
FMG-23K	2' x 3'	Black	Each	24

ANTI-SLIP & ANTI-FATIGUE FLOOR MATS



Beveled edge

1/2" thick

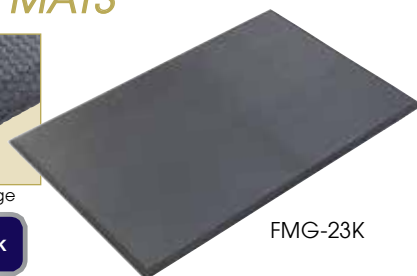

FMG-23K

STRAIGHT EDGE NATURAL RUBBER FLOOR MATS

- ◆ Anti-slip & anti-fatigue top-grade natural rubber
- ◆ Excellent drainage in wet areas
- ◆ All straight-edge mats are grease-resistant - use in grease-prone areas to prevent slipping
- ◆ Trim to customize size for best fit
- ◆ 3/4" thick

ITEM	DESCRIPTION	COLOR	UOM	CASE
RBMH-35K	3' x 5'	Black	Each	1
RBMH-35R	3' x 5'	Red	Each	1
RBMH-35K-R	3' x 5', Rolled	Black	Each	1
RBMH-35R-R	3' x 5', Rolled	Red	Each	1

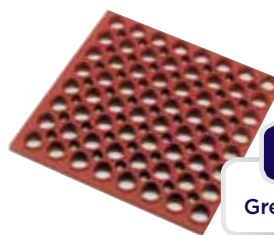

RBMH-35R



RBMH-35K

3/4" thick

Grease-resistant

Available flat or rolled

BEVELED EDGE FLOOR MATS

- ◆ Anti-slip & anti-fatigue top-grade natural rubber
- ◆ Tapered edges help reduce tripping
- ◆ RED beveled edge mats are grease-resistant - use in grease-prone areas to prevent slipping
- ◆ 1/2" thick

ITEM	DESCRIPTION	COLOR	UOM	CASE
RBM-35K	3' x 5'	Black	Each	1
RBM-35R	3' x 5', Grease-Resist	Red	Each	1
RBM-35K-R	3' x 5', Rolled	Black	Each	1
RBM-35R-R	3' x 5', Rolled, Grease-Resist	Red	Each	1

Red beveled mats are grease-resistant

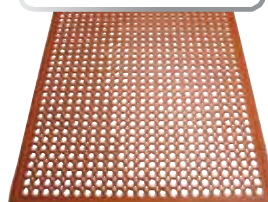

RBM-35R

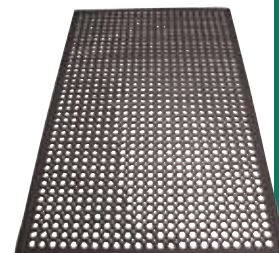

RBM-35K

1/2" thick

INTERLOCKING FLOOR MATS

- ◆ Molded-in connectors for self-locking system
- ◆ Create custom shapes/sizes to fit various applications
- ◆ RED interlocking mat is grease-resistant - use in grease-prone areas to prevent slipping
- ◆ Anti-slip & anti-fatigue
- ◆ 1/2" thick

ITEM	DESCRIPTION	COLOR	UOM	CASE
RBMI-33K	3' x 3'	Black	Each	1
RBMI-33R	3' x 3', Grease-Resist	Red	Each	1

Red interlocking mat is grease-resistant

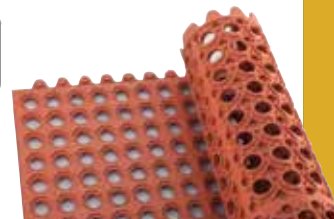

RBMI-33R

WASTE BASKETS



PWR-41BE



PWR-28K



PWR-28L

WASTE BASKETS

These anti-jamming plastic cans feature a rolled edge for added strength and easy grip.

- ◆ 28 or 41 quart capacity options

ITEM	DESCRIPTION	COLOR	UOM	CASE
PWR-28BE	28 Qt	Beige	Each	1/12
PWR-28K	28 Qt	Black	Each	1/12
PWR-28L	28 Qt, RECYCLE	Blue	Each	1/12
PWR-41BE	41 Qt	Beige	Each	1/12
PWR-41K	41 Qt	Black	Each	1/12

SLENDER TRASH CANS & LIDS



PTC-23GRC & PTCL-23GR



PTC-23SG & PTCL-23

SLENDER TRASH CANS

- ◆ Compact size is great for use in locations where space is limited
- ◆ Rolled top-rim for added strength
- ◆ Rounded edges and corners for easier cleaning
- ◆ Made of durable, high-density polypropylene making it resistant to moisture and certain cleaning solutions
- ◆ Lids sold separately

ITEM	DESCRIPTION	COLOR	UOM	CASE
PTC-23GRC	23 Gallon, Compost	Green	Each	1
PTC-23L	23 Gallon, Recycle	Blue	Each	1
PTC-23K	23 Gallon	Black	Each	1
PTC-23SG	23 Gallon	Gray	Each	1
PTC-23B	23 Gallon	Brown	Each	1



PTCL-23L



PTCL-23K



PTCL-23B

LIDS FOR SLENDER TRASH CANS

- ◆ Counterbalanced swing lids

ITEM	DESCRIPTION	COLOR	UOM	CASE
PTCL-23GR	Lid for PTC-23GRC	Green	Each	4
PTCL-23L	Lid for PTC-23L	Blue	Each	4
PTCL-23K	Lid for PTC-23K	Black	Each	4
PTCL-23	Lid for PTC-23SG	Gray	Each	4
PTCL-23B	Lid for PTC-23B	Brown	Each	4



PTC-23L



PTC-23K



PTC-23B

SPECIALTY LIDS

ITEM	DESCRIPTION	COLOR	UOM	CASE
PTCB-23L	Bottle/Can Recycling Cover for PTC-23L	Blue	Each	1/6
PTCP-23L	Paper Recycling Cover for PTC-23L	Blue	Each	1/6



PTCB-23L



PTCP-23L

CART FOR SLENDER TRASH CANS

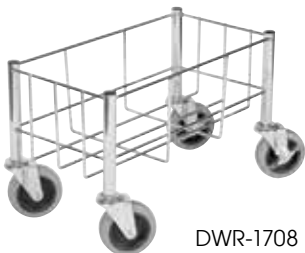

DWR-1708



Fits most standard slim trash cans

WIRE DOLLY FOR SLENDER TRASH CANS

Give slender trash cans mobility to move from one location to another with the ease of this rolling cart built for the task.

- ◆ 400 Lbs capacity with 3-3/4" non-marking casters
- ◆ Zinc-plated to resist rust and corrosion
- ◆ Compatible with PTC-Series 23 gallon slender trash cans

ITEM	DESCRIPTION	UOM	CASE
DWR-1708	18-1/2"L x 9-1/2"W x 12"H	Each	4

Shown with PTC-23SG

ROUND TRASH CAN & LID

- ◆ Trash can and lid sold separately

ITEM	DESCRIPTION	COLOR	UOM	CASE
PTCR-22G	22 Gallon	Gray	Each	1
PTCRL-22G	Lid for PTCR-22G	Gray	Each	12



Lid and can sold separately



Top view of lid



PTCRL-22G



PTCR-22G

SQUARE CANS & LIDS

SQUARE TRASH CANS AND LIDS

- ◆ Large 23 or 35 gallon sizes ideal for high-traffic areas
- ◆ Soft-close gravity lids, no springs
- ◆ Trash cans and lids sold separately



ITEM	DESCRIPTION	COLOR	UOM	CASE
PTCS-23BE	23 Gallon	Beige	Each	1
PTCS-23G	23 Gallon	Gray	Each	1
PTCS-23L	23 Gallon, RECYCLE	Blue	Each	1
PTCS-35BE	35 Gallon	Beige	Each	1
PTCS-35G	35 Gallon	Gray	Each	1
PTCSL-23BE	Lid for PTCS-23BE	Beige	Each	10
PTCSL-23G	Lid for PTCS-23G	Gray	Each	10
PTCSB-23L	Bottle/Can Lid for PTCS-23L	Blue	Each	24
PTCSP-23L	Paper Lid for PTCS-23L	Blue	Each	24
PTCSL-35BE	Lid for PTCS-35BE	Beige	Each	6
PTCSL-35G	Lid for PTCS-35G	Gray	Each	6



PTCSB-23L



PTCS-23L & PTCSP-23L



PTCS-35G & PTCSL-35G



PTCS-35BE

WASTE RECEPTACLE

- ◆ For indoor use
- ◆ Features tray-top design with 9"H self-return door
- ◆ Fits up to 35 gallon capacity trash can
- ◆ Inside dimensions: 22-7/16"L x 22-7/16"W x 41-11/32"H
- ◆ Ships knocked down
- ◆ Light natural-wood color



ITEM	DESCRIPTION	UOM	CASE
WR-35	23-1/2"L x 23-3/4"W x 44"H	Each	1



Self-return swing door



Use PTCR-35G as liner in WR-35



WR-35

WASTE RECEPTACLE

HEAVY-DUTY TRASH CANS



PTC-32G & PTCL-32G



Locking threads underneath can



Large easy-grip handles

FCW-Series also safe for food storage



FCW-10RC



FCW-10 & FCW-10L

NSF FCW-SERIES

BPA FREE CONTAINERS & SOLID LIDS

HEAVY-DUTY TRASH CANS

◆ Lids sold separately

ITEM	DESCRIPTION	COLOR	UOM	CASE
PTC-10G	10 Gallon	Gray	Each	1
PTC-10W	10 Gallon	White	Each	1
PTC-20G*	20 Gallon	Gray	Each	1
PTC-20W*	20 Gallon	White	Each	1
PTC-32G*	32 Gallon	Gray	Each	1
PTC-44G*	44 Gallon	Gray	Each	1
FCW-10	10 Gallon, NSF	White	Each	1/6
FCW-20*	20 Gallon, NSF	White	Each	1/6

*Works with DLR-series dollies

WHITE CANS: FOOD STORAGE CAPACITIES

ITEM #	CAPACITY (GALLONS)	CAPACITY (CUPS)	FLOUR (LBS)	SUGAR (LBS)
FCW-10	10	150	47	65
FCW-20	20	300	94	130

HEAVY-DUTY TRASH CAN LIDS

ITEM	DESCRIPTION	COLOR	UOM	CASE
PTCL-10G	Lid for PTC-10G	Gray	Each	10
PTCL-10W	Lid for PTC-10W	White	Each	10
PTCL-20G	Lid for PTC-20G	Gray	Each	10
PTCL-20W	Lid for PTC-20W	White	Each	10
PTCL-32	Lid for PTC-32G	Gray	Each	6
PTCL-44	Lid for PTC-44G	Gray	Each	6
FCW-10L	Lid for FCW-10, NSF	White	Each	1/24
FCW-20L	Lid for FCW-20, NSF	White	Each	1/12
FCW-10RC	Rotating Lid for FCW-10, NSF	White	Each	1/6

TWIST-ON DOLLIES



DLR-2



Locking threads

Twist on for secure fit

DOLLIES FIT MOST ROUND COMMERCIAL TRASH CANS

EXTRA HEAVY-DUTY DOLLY

◆ Holds up to 900 lbs

ITEM	DESCRIPTION	UOM	CASE
DLR-2	Extra-Heavy Dolly	Each	2
DLR-2-C	Caster for DLR-2	Each	1



DLR-18

DOLLY

◆ Holds up to 400 lbs

ITEM	DESCRIPTION	UOM	CASE
DLR-18	18"Dia x 6"H, Black	Each	2
DLR-18-W	Caster for DLR-18	Each	1

SUPPLIES CADDY



PJC-1511K



JANITORIAL SUPPLIES CADDY

- ◆ 3 deep compartments hold a variety of supplies
- ◆ 15-1/4"W x 10-3/4"D x 6-3/4"H
- ◆ Center carry handle

ITEM	DESCRIPTION	UOM	CASE
PJC-1511K	Janitorial Caddy	Each	1/12

JANITORIAL CART WITH BAG AND 3 SHELVES

- ◆ Durable plastic construction with 25 gallon nylon bag
- ◆ 3 shelves and front platform with raised retaining edges
- ◆ (2) 8" non-skid wheels and (2) 3" non-skid swivel casters
- ◆ 45"L x 18-1/4"W x 38-1/4"H

ITEM	DESCRIPTION	UOM	CASE
PJC-4538	Janitorial Cart, Black	Each	1/1
PJC-4538B	Bag Replacement, Yellow	Each	1/10



Keep all supplies within reach

JANITORIAL CART



Load and Go!



PJC-4538

CONTAINER CADDY BAG

- ◆ Water-resistant material
- ◆ 29"L x 20"H with adjustable straps
- ◆ Multiple pockets fit a variety of cleaning supplies

ITEM	DESCRIPTION	UOM	CASE
JCB-2920	Fits 32 and 44 Gallon Cans	Each	6

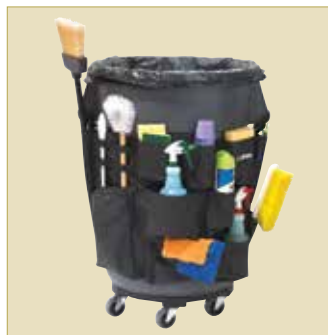

Multiple pockets fit a variety of cleaning supplies

CONTAINER CADDY BAG



JCB-2920

CONTAINER CADDY FOR 44 GALLON CONTAINER

- ◆ Convenient, durable caddy keeps supplies handy for a variety of cleaning tasks
- ◆ Holds two bags open at once for dual disposal option

ITEM	DESCRIPTION	UOM	CASE
TCD-44Y	Fits 44 Gallon PTC-44G	Each	5



Many compartments of varying sizes

CONTAINER CADDY FOR 44 GALLON CONTAINER



TCD-44Y

MOP BUCKETS

26qt capacity sized for tight spaces



MPB-26

MOP BUCKETS WITH SIDE-PRESS WRINGER

- ◆ Easily lift-and-empty by grasping the molded handle at rear and the bail handle on front of bucket
- ◆ Base of bucket slopes downward toward wringer, keeping dirt particles away from mop
- ◆ Side-press wringer features rubber grip and heavy-duty spring action to effectively wring out mops
- ◆ Swivel casters with 3" wheels maneuver over thresholds or onto elevators; the bumpers protect walls

26QT MOP BUCKET WITH SIDE PRESS WRINGER

- ◆ COMPACT: 15"L x 19"D x 34-1/2"H; Bucket 15-1/2"H
- ◆ Sized for quick-clean jobs and storing in janitorial closets

ITEM	DESCRIPTION	COLOR	UOM	CASE
MPB-26	26Qt Bucket & Wringer Combo	Yellow	Each	1
MPB-36WH	Caster Wheel for MPB-Series		Each	4

26qt and 36qt side-press wringers & buckets are interchangeable

36QT MOP BUCKETS WITH SIDE PRESS WRINGER

- ◆ Size: 16-1/2"L x 23"D x 36"H; Bucket 16-1/2"H

ITEM	DESCRIPTION	COLOR	UOM	CASE
MPB-36	36Qt Bucket & Wringer Combo	Yellow	Each	1
MPB-36B	36Qt Bucket	Yellow	Each	1
MPB-36W	Side-Press Wringer	Yellow	Each	2
MPB-36R	36Qt Bucket & Wringer Combo	Red	Each	1
MPB-36BR	36Qt Bucket	Red	Each	1
MPB-36WR	Side-Press Wringer	Red	Each	2
MPB-36WH	Caster Wheel for MPB-Series		Each	4



MPB-36



MPB-36R

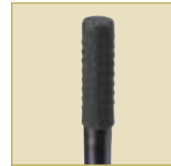

Powder-coated wringer handle with rubber grip



Non-marking casters with bumpers

FLOOR "CAUTION" SIGNS



WCS-27T

WCS-25

CSF-4

FLOOR "CAUTION" SIGNS

ITEM	DESCRIPTION	UOM	CASE
WCS-27T	27"H Cone, "Caution Wet Floor"	Each	5
WCS-25	25" x 12" Sign, English/Spanish "Caution Wet Floor"	Each	12
CSF-4	19-3/4"H Pop-Up Cone, Trilingual "Caution"	Each	12/48
CSF-SET	Pop-Up "Caution" Cone & Wall-Mount Holder Set	Set	6/36



CSF-SET



Set includes pop-up "Caution" cone

SUPERIOR MICROFIBER LOOP-END WET MOPS

- ◆ Extremely absorbent microfiber mop heads for quick, efficient cleaning
- ◆ Loop-end; tail band fans out strands for more coverage
- ◆ Machine washable

ITEM	DESCRIPTION	UOM	CASE
MOPM-M	Medium	Each	12
MOPM-L	Large	Each	12



Looped ends prevent unraveling

WET MOPS



MOPM-M shown with MOPH-7P handle and MPB-36 mop bucket



MOPM-M

PREMIUM COTTON-POLY BLEND LOOP-END WET MOPS

- ◆ Absorbent cotton-poly blend mop heads
- ◆ Loop-end 4-ply yarn; tail band fans out strands for more mopping coverage
- ◆ 1-1/4" wide headband
- ◆ Machine washable

ITEM	DESCRIPTION	SIZE	UOM	CASE
MOP-20	Blue Tailband	20oz/570g	Each	20
MOP-24	Blue Tailband	24oz/680g	Each	20
MOP-32	Blue Tailband	32oz/900g	Each	20
MOP-20W	White Tailband	20oz/570g	Each	20
MOP-24W	White Tailband	24oz/680g	Each	20
MOP-32W	White Tailband	32oz/900g	Each	20



Looped ends prevent unraveling



Brick pack is standard

Headband

NEW SIZES



MOP-32W

Tail band

ECONOMY COTTON-POLY BLEND CUT-END WET MOPS

- ◆ Absorbent cotton-poly blend mop heads
- ◆ Cut end 4-ply yarn
- ◆ 1-1/4" wide headband

ITEM	DESCRIPTION	SIZE	UOM	CASE
MOP-20C	Blue	20oz/570g	Each	20
MOP-24C	Blue	24oz/680g	Each	20
MOP-32C	Blue	32oz/900g	Each	20
MOP-20WC	White	20oz/570g	Each	20
MOP-24WC	White	24oz/680g	Each	20
MOP-32WC	White	32oz/900g	Each	20



Brick pack is standard

Headband

NEW SIZES



MOP-24C

DISPENSER FOR BRICK PACKS

- ◆ Holds seven brick packs
- ◆ Mount to wall in janitorial supplies closet for convenient and compact storage

ITEM	DESCRIPTION	UOM	CASE
MOPR-22	8" x 6-5/8" x 22"	Each	6

Holds 7 brick packs



MOPR-22



MOP HANDLES

ITEM	DESCRIPTION	SIZE	UOM	CASE
MOPH-7M	Metal, Quick-Change Screw	57"L	Each	6
MOPH-7P	Plastic, Side-Release Dial	57"L	Each	6



MOPH-7P



MOPH-7M

WINDOW SQUEEGEES



WINDOW SQUEEGEES

ITEM	DESCRIPTION	UOM	CASE
WSS-12	12" Squeegee with 23" HdL	Each	6/24
WS-15	15" Squeegee with Telescopic Alu Handle - Extends from 30" to 55"	Each	20
FSS-24	24" Single Blade Squeegee - Handle sold separately	Each	6
FSC-60H	55" Tapered Wooden Handle for FSS-24	Each	6

FLOOR SQUEEGEES



FSS-18DF



FSS-24DF

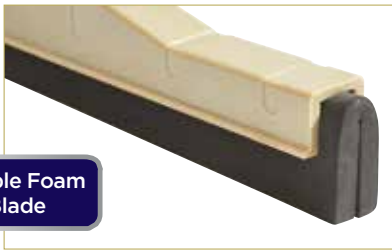

Double Foam Blade

DOUBLE FOAM BLADE FLOOR SQUEEGEES

- ◆ Lightweight helps reduce strain
- ◆ Non-scratch and absorbent
- ◆ Easy to attach and secure handle

ITEM	DESCRIPTION	UOM	CASE
FSS-18DF	18"W Floor Squeegee Head, Double-Foam EVA Blade, Plastic Frame	Each	1/25
FSS-24DF	22"W Floor Squeegee Head, Double-Foam EVA Blade, Plastic Frame	Each	25



Adapts to variety of surfaces



Single rubber blade

FSS-24

SINGLE RUBBER BLADE FLOOR SQUEEGEE

ITEM	DESCRIPTION	UOM	CASE
FSS-24	24"W Single Blade Floor Squeegee Head	Each	6

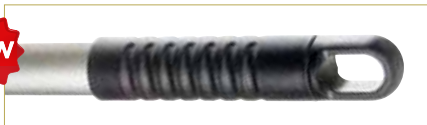

Non-slip comfort grip

FSS-DFH



FSC-60H

HANDLES

ITEM	DESCRIPTION	UOM	CASE
FSS-DFH	49-1/4"L Aluminum Handle for FSS-Series	Each	50
FSC-60H	55" Tapered Wooden Handle for FSS-Series	Each	6

FLOOR DRAIN STRAINER



FDS-1010

STAINLESS STEEL FLOOR DRAIN STRAINER

Catch debris while water drains through perforations.

- ◆ 8-5/8" interior area; 10" wide overall; 2-5/8" high; 3/4" wide top rim

ITEM	DESCRIPTION	UOM	CASE
FDS-1010	10"L x 10"W x 2-5/8"H	Each	12



Nitrile Gloves
#GLN-Series



- WINCO PRODUCTS - MERCHANDISING DISPLAY PROGRAM

DISPLAY
available with
qualifying order



Fill with mops, brooms...
anything with a handle



See your sales rep for program details

DUST MOP HEADS, FRAMES & HANDLES

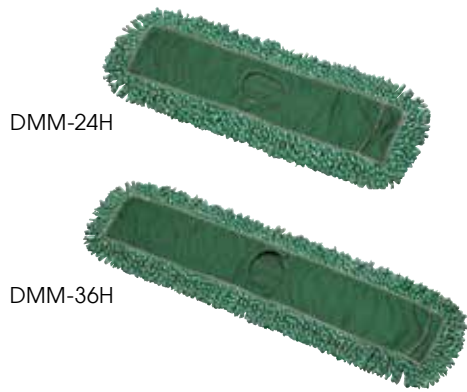

DMM-24H

DMM-36H

DUST MOP HEADS

- ◆ Microfiber blend effectively traps dust and lint
- ◆ Fits standard size frames



SUPERIOR DUST MOP HEADS

- ◆ Microfiber blend effectively traps dust and lint

ITEM	DESCRIPTION	COLOR	UOM	CASE
DMM-24H	24"	Green	Each	24
DMM-36H	36"	Green	Each	24

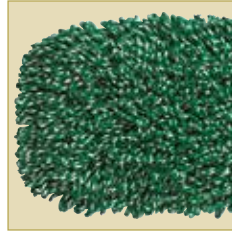

Looped-ends prevent unraveling



Brick pack is standard

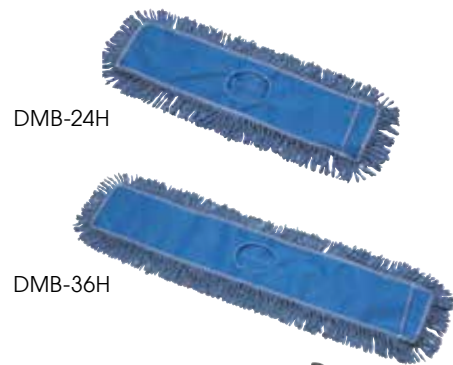

DMB-24H

DMB-36H



PREMIUM DUST MOP HEADS

- ◆ Cotton blend collects and traps dirt and dust

ITEM	DESCRIPTION	COLOR	UOM	CASE
DMB-24H	24"	Blue	Each	24
DMB-36H	36"	Blue	Each	24



Looped-ends prevent unraveling



Brick pack is standard

Replacement heads, wired frame & handle available as a set, or sold separately

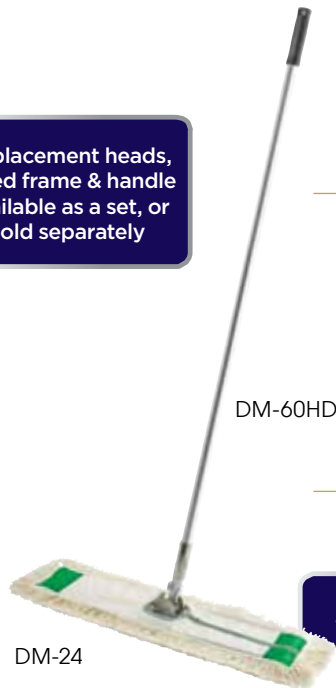

DM-60HD

DM-24

Machine washable

DM-24H

QUALITY DUST MOPS

- ◆ Features nylon backing & convenient zippered closure for easy on-and-off
- ◆ 100% cotton

ITEM	DESCRIPTION	COLOR	UOM	CASE
DM-24H	24"	White	Each	1/24
DM-36H	36"	White	Each	24

DUST MOP SETS: MOP HEADS W/FRAME & HANDLE

- ◆ Sets include frame, mop head and 60"L handle

ITEM	DESCRIPTION	COLOR	UOM	CASE
DM-24	24" Mop, Frame, 60"L Handle	White	Set	1/6
DM-36	36" Mop, Frame, 60"L Handle	White	Set	1/6

DM-36FM

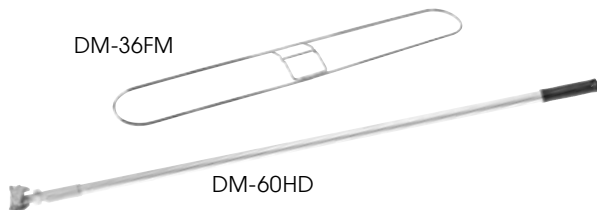

DM-60HD

DUST MOP FRAMES & HANDLE

- ◆ Wire frames compatible with 24" or 36" mop heads
- ◆ 60" long lightweight aluminum handle

ITEM	DESCRIPTION	UOM	CASE
DM-24FM	Wire Frame, 24"	Each	24
DM-36FM	Wire Frame, 36"	Each	24
DM-60HD	Aluminum Handle, 60"L	Each	12

BROOMS & BRUSHES

PREMIUM BROOMS

- ◆ Two-position handle options - upright or angled
- ◆ Long-wear angled bristles to clean hard-to-reach places
- ◆ Excellent for sweeping dust and debris

HEAVY-DUTY UNFLAGGED ANGLED BROOMS

ITEM	DESCRIPTION	COLOR	UOM	CASE
BRAU-9K	Unflagged	Black	Each	12
BRAU-9K-H	Unflagged Broom w/48"L Fiberglass Handle	Black	Set	12

MEDIUM-DUTY FLAGGED ANGLED BROOMS

ITEM	DESCRIPTION	COLOR	UOM	CASE
BRAF-9R	Flagged	Red	Each	12
BRAF-9R-H	Flagged Broom w/48"L Fiberglass Handle	Red	Set	12

MEDIUM-DUTY FLAGGED LOBBY BROOM W/30"L HANDLE

ITEM	DESCRIPTION	COLOR	UOM	CASE
BRF-6K-H	Flagged, 30"L Hdl	Black	Set	12/24

ECONOMY FLAGGED ANGLED BROOM W/47.5"L HANDLE

ITEM	DESCRIPTION	COLOR	UOM	CASE
BRM-60L	Flagged, 47.5"L Hdl	Black	Each	12

PREMIUM PUSH BROOMS

- ◆ Structural foam head is lightweight and provides superior long-lasting durability (handles sold separately)
- ◆ Resistant to the elements; will not rust or rot

PUSH BROOMS - FINE, MEDIUM-DUTY

- ◆ Fine bristles sweep up small particles and debris
- ◆ Ideal for general indoor use like wood, concrete, and tile

ITEM	DESCRIPTION	COLOR	UOM	CASE
BRFF-18K	18"W	Black	Each	1/12
BRFF-24K	24"W	Black	Each	1/12

PUSH BROOMS - COARSE, HEAVY-DUTY

- ◆ Coarse bristles picks up heavy debris and large particles
- ◆ Ideal for outdoor use on rough surfaces such as warehouses, receiving areas and sidewalks

ITEM	DESCRIPTION	COLOR	UOM	CASE
BRFC-18B	18"W	Brown	Each	1/12
BRFC-24B	24"W	Brown	Each	1/12

DECK BRUSH: 10"W MULTI-ANGLE FLOOR SCRUB BRUSH

- ◆ 0.6mm synthetic bristles

ITEM	DESCRIPTION	UOM	CASE
BRF-10R	10"W	Each	1/12

12"W MULTI-ANGLE FLOOR SCRUB BRUSH

- ◆ 0.6mm crimped synthetic bristles
- ◆ Angled side bristles ideal for baseboards, under counters and around corners

ITEM	DESCRIPTION	UOM	CASE
BRF-12Y	12"W	Each	12

BROOM HANDLES - FIBERGLASS W/TEXTURED GRIP

- ◆ Durable fiberglass construction with textured surface to provide soft comfortable grip
- ◆ Thread onto broom head for secure fit
- ◆ 1" diameter

ITEM	DESCRIPTION	UOM	CASE
BRH-48K	48"L	Each	12
BRH-60K	60"L	Each	12

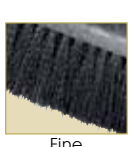

HANDLES



CARPET / FLOOR SWEEPER



FSW-11



ROTARY SWEEPER

- ◆ Quiet non-electric rotary sweeper ideal for quick cleanups from multiple surfaces
- ◆ Rotating natural bristles sweep debris into pan as you go
- ◆ Lightweight, portable, and easy to empty
- ◆ Folds flat for compact storage

ITEM	DESCRIPTION	UOM	CASE
FSW-11	11"L x 7-3/4"W x 43"H	Each	1/4

Sweep up quick and quiet

DUST PANS

DUST PANS

ITEM	DESCRIPTION	UOM	CASE
DP-13C	Lobby Dust Pan with Cover, Black, 13"W	Set	1/10
DP-14R	Jumbo Upright Dust Pan, Red, 13-5/8" x 14" x 8-7/8"	Set	12
DP-1618K	Large Floor Dust Pan, Black, 16" x 18" x 5-1/4"	Each	12



DP-13C



DP-14R



Rubber blade edging

Upright



Rubber blade edging

DP-1618K

MOP & BROOM RACKS

MOP & BROOM RACKS

Outfitted with non-slip bristles, hooks and clips, maximize space and keep kitchen cleaning tools organized and within reach.

- ◆ MHH-36 & MHH-24 constructed of aluminum with non-slip rubber bristles that hold tools securely in place
- ◆ MHH-5 constructed of durable ABS plastic with 5 clips and 6 hooks



MHH-36



MHH-5



ITEM	DESCRIPTION	UOM	CASE
MHH-5	16"L, 5 Clips and 6 Hooks	Each	1/12
MHH-24	24"L Mop Rack, Rubber Bristles	Each	6/24
MHH-36	36"L Mop Rack, Rubber Bristles	Each	6/12

HEAVY-DUTY NATURAL LATEX GLOVES

- ◆ Soft, comfortable and durable
- ◆ Made especially for dish washers, launderers, car washers and gardeners

ITEM	DESCRIPTION	UOM	CASE
NLGH-18	10-1/2" x 18-1/2"	Pair	12/24

GLOVES



NLGH-18

NATURAL LATEX GLOVES

ITEM	DESCRIPTION	UOM	CASE
NLG-816	Small, Yellow	Pair	12/60
NLG-916	Medium, Yellow	Pair	12/60
NLG-1018	Large, Black	Pair	12/60



NLG-816



NLG-1018

DISPOSABLE BLACK NITRILE GLOVES

- ◆ Durable, flexible 3 mil nitrile
- ◆ Rolled-edge cuff protects from drips
- ◆ Powder-free, Latex-free
- ◆ 100 pieces per box

ITEM	DESCRIPTION	UOM	CASE
GLN-MB	Medium	Box	1/10
GLN-LB	Large	Box	1/10

100 pcs/box



GLN-MB

DISPOSABLE MULTI-PURPOSE POLY GLOVES

- ◆ Easy on and off
- ◆ Powder-free, Latex-free
- ◆ 500 pieces per box

ITEM	DESCRIPTION	UOM	CASE
GLP-M	Medium	Box	1/10
GLP-L	Large	Box	1/10

500 pcs/box



GLP-M

RECTANGLE GLOVE BOX BRACKETS

ITEM	DESCRIPTION	UOM	CASE
WHW-10	10-1/4" x 3-1/4" x 4-5/8", Fits 9-3/4" x 2-7/8" Box	Each	12/24
WHW-11	10-1/4" x 3-5/8" x 5", Fits 9-3/4" x 3-1/4" Box	Each	12/24

WALL-MOUNT BRACKETS



WHW-11



WHW-10

Gloves sold separately

ROUND WIPES CANISTER BRACKET

- ◆ Made to fit round containers up to 5-1/4" diameter (not included)
- ◆ Easily mounts in accessible location

ITEM	DESCRIPTION	UOM	CASE
WHW-6	Round Container Bracket	Each	12/24

Replaces WHW-5



WHW-6

RETRACTABLE BOX CUTTER

- ◆ Blade retracts into metal safety sleeve
- ◆ Open boxes, slice cardboard

ITEM	DESCRIPTION	UOM	CASE
BXC-4	4"L Box Cutter	Doz	5/50
BXC-B100	Replacement Blade, 100-Pcs/Pk	Pack	5/50

BOX CUTTER

Handy tool



BXC-B100



BXC-4

PLASTIC SPRAY BOTTLES



PLASTIC 28 OUNCE SPRAY BOTTLES

Durable easy-spray color-coded bottles for effective spot cleaning and sanitizing.

- ◆ 28 oz (828 ml)
- ◆ Adjustable spray nozzle with two settings: Mist and Stream
- ◆ Easy-read fill lines indicate capacity
- ◆ Use with cleaning and chemical solutions

ITEM	DESCRIPTION	UOM	CASE
PSR-9	Green	Each	50
PSR-9B	Blue	Each	50
PSR-9R	Red	Each	50
PSR-9W	White	Each	50
PSR-9Y	Yellow	Each	50

UTILITY APRONS



DISHWASHING APRONS

- ◆ Water resistant
- ◆ Black apron is lightweight nylon/PVC/polyester blend
- ◆ Brown apron is heavyweight vinyl with faux leather front

ITEM	DESCRIPTION	SIZE	UOM	CASE
BAW-2540BK	Black	27-1/2"W x 40"L	Each	12/60
BAW-2740BN	Brown	25-1/2"W x 40"L	Each	12/60



HEAVY VINYL BLACK APRONS

ITEM	DESCRIPTION	SIZE	UOM	CASE
BA-HN	Heavy Vinyl w/Pocket	26-1/2"W x 41-1/4"L	Each	12/24
BA-LA	Latex	37"W x 44-1/2"L	Each	12



BADP-2846

DISPOSABLE APRON

Quickly slip on over clothing to protect from spills and splashes.

- ◆ White plastic, waterproof bib apron
- ◆ 1 mil standard weight
- ◆ Disposable for easy, mess-free clean up
- ◆ One size fits most

ITEM	DESCRIPTION	SIZE	UOM	CASE
BADP-2846	Disposable Bib Apron	28" x 46"	Each	1/12



UTILITY PAILS

- ◆ Wide pour spout and easy-lift handle
- ◆ Quickly gauge capacity with molded-in measure marks

ITEM	DESCRIPTION	UOM	CASE
UPP-10G	10 Qt, Gray	Each	1/12
UPP-10R	10 Qt, Red	Each	1/12
UPP-14G	14 Qt, Gray	Each	1/12
UPP-14R	14 Qt, Red	Each	1/12



UTILITY PAILS & BUCKETS



UPP-14G

UPP-10R

CLEANING BUCKETS

- ◆ Green for "SOAP SOLUTION"
- ◆ Red for "SANITIZING SOLUTION"
- ◆ Do Not use cleaning buckets with food products

ITEM	DESCRIPTION	UOM	CASE
PPL-3G	3 Qt, Green	Each	12
PPL-3R	3 Qt, Red	Each	12
PPL-6G	6 Qt, Green	Each	12
PPL-6R	6 Qt, Red	Each	12



PPL-6R



PPL-6G

CELLULOSE BIODEGRADABLE SPONGE

- ◆ Non-abrasive cleaning
- ◆ 3 pieces per pack

ITEM	DESCRIPTION	UOM	CASE
SP-C64Y	6"L x 4-1/4"W x 1-1/2"H	Pack	10



SP-C64Y

SPONGES

DUAL-SURFACE GENERAL-DUTY SCRUB SPONGE

- ◆ Yellow side wipes, green side scrubs without scratching
- ◆ 3 pieces per pack

ITEM	DESCRIPTION	UOM	CASE
SP-SC63	6"L x 3-5/8"W	Pack	10



SP-SC63

NYLON SCOURING PADS

- ◆ Heavy duty cleaning
- ◆ 6 pieces per pack

ITEM	DESCRIPTION	UOM	CASE
SP-96N	6" x 9-3/8" Pack Size	Pack	1/60



SP-96N

STAINLESS STEEL SPONGES

- ◆ Heavy duty, abrasive cleaning
- ◆ 1 piece per pack

ITEM	DESCRIPTION	UOM	CASE
SPG-50	50g	Each	12/144
SPG-105	105g	Each	12/72



SPG-50

Prevent cross-contamination with color-coded supplies

GREEN

GENERAL
Food Prep & Service Areas
Bar, Tables

BLUE

LOW RISK
Front of House
Door Handles, Railings, Mirrors

RED

HIGH RISK
Hazard Areas
Toilets, Restroom Fixtures

THE
CLEANING
BUCKET

SANITIZING SOLUTION

NOT FOR USE WITH FOOD PRODUCT

- Always follow manufacturer's instructions for mixing cleaning solution
- Rinse and wash nail thoroughly in between us
- Mix a new batch of cleaning solution or don't, do not re-use dirty solution
- Use green pail for cleaning with soap
- Use red pail for sanitizing solutions

6 Qt.

Wincos

MICROFIBER TOWEL ROLL & HOLDER

At a moment's notice, tear individual microfiber towels right from a compact towel roll. Perfect for clean up in the bar, kitchen, and more.

- ◆ Quick access, quick dispensing, space efficient
- ◆ Non-scratch and lint-free
- ◆ 12" x 12" sheets; 50 sheets per roll

ITEM	DESCRIPTION	UOM	CASE
BTM-12B	Blue Towel Roll	Pack	12
WHW-12	Towel Roll Holder, White	Each	6/24

TOWELS



BTM-12B with WHW-12



BTM-12B

MICROFIBER TOWELS

Removes more bacteria than regular cotton cleaning cloths.

- ◆ Lightweight, absorbent and quick drying
- ◆ BTM-16AC colors: yellow, blue, white, green, orange, red
- ◆ Each pack includes hanging display hook

ITEM	DESCRIPTION	UOM	CASE
BTM-16AC	16" x 16", Assorted Colors	Pack	1/20
BTM-16B	16" x 16", Blue	Pack	1/20
BTM-16G	16" x 16", Green	Pack	1/20
BTM-16R	16" x 16", Red	Pack	1/20
BTM-16W	16" x 16", White	Pack	1/20



BTM-16AC



BTM-16W



BTM-16R



BTM-16G



BTM-16B

COTTON GLASS-POLISHING TOWEL

- ◆ Absorbent 100% cotton
- ◆ Lint-free and non-abrasive; gentle on glass & non-streaking
- ◆ Effectively picks up dirt and dust
- ◆ Red stripe towel can be designated for a specific station or use, or to prevent cross-contamination

ITEM	DESCRIPTION	UOM	CASE
BTGP-21	16" x 29", Red Pinstripes	Doz	10/20



BTGP-21

COTTON-BLEND HERRINGBONE TOWEL

- ◆ Super absorbent cotton-blend (70% cotton 30% polyester)
- ◆ Ideal for wiping down bar top, tables or countertops
- ◆ Green stripe towel can be designated for a specific station or use, or to prevent cross-contamination

ITEM	DESCRIPTION	UOM	CASE
BTH-2028G	20" x 28"	Doz	10/20



BTH-2028G

WHITE COTTON BAR TOWEL

- ◆ 100% cotton

ITEM	DESCRIPTION	UOM	CASE
BTW-30	16" x 19"	Doz	10/20



BTW-30

BRUSHES



BRN-52



Dual high-low bristles

NAIL CLEANING BRUSH

- ◆ Synthetic high-low bristles effectively scrub nails without damage to surrounding skin
- ◆ Easy-grip contoured handle; molded-in bristles
- ◆ Contour design prevents surface contact when stored on side, preventing contamination

ITEM	DESCRIPTION	UOM	CASE
BRN-52	5-3/4"L x 2"W	Each	12/48

BOTTLE CLEANING BRUSH

- ◆ Ergonomic handle helps to reduce strain when washing bottles, glasses, pitchers/carafes
- ◆ Soft, durable bristles effectively remove residue without scratching
- ◆ Easily reaches into narrow bottle necks and inner corners

ITEM	DESCRIPTION	COLOR	UOM	CASE
BRB-12	12"L x 2-3/4" Dia	White	Each	12/48

BPA FREE

BRB-12



VEGETABLE CLEANING BRUSH

- ◆ Firm bristles effectively remove dirt and impurities from vegetable skins
- ◆ Circular opening surrounds cucumbers, carrots or zucchini for a thorough, all-around cleaning
- ◆ Comfortable, easy-grip ergonomic handle

ITEM	DESCRIPTION	COLOR	UOM	CASE
BRV-10	9-1/4"L x 4-3/4"W	White	Each	12/48

BPA FREE

BRV-10



COUNTER CLEANING BRUSH

- ◆ Synthetic bristles will not damage counter surfaces
- ◆ Ergonomic handle design for ultimate comfort

ITEM	DESCRIPTION	UOM	CASE
BRC-14Y	14-1/4" O.L.	Each	12

BPA FREE

BRC-14Y



HACCP COLOR-CODED CUTTING BOARD BRUSHES

- ◆ Firm, synthetic bristles get surfaces clean
- ◆ Contoured shape for easy-grip and wide scrubbing area
- ◆ Colors can designate specific types of cleaning

ITEM	DESCRIPTION	UOM	CASE
CBR-WT	White	Each	24/96
CBR-BN	Brown	Each	24/96
CBR-BU	Blue	Each	24/96
CBR-GR	Green	Each	24/96
CBR-RD	Red	Each	24/96
CBR-YL	Yellow	Each	24/96



CBR-SERIES

BAR MAID® GLASS WASHER BRUSHES

- ◆ Suction base provides stability on slippery surfaces
- ◆ Dishwasher safe

ITEM	DESCRIPTION	UOM	CASE
GWM-200	2 Brushes with Suction Cup Base, 8"H x 7-1/2"W	Box	1/6
GWM-300	3 Brushes with Suction Cup Base, 8"H x 9-1/2"W	Box	1/6



BRUSHES

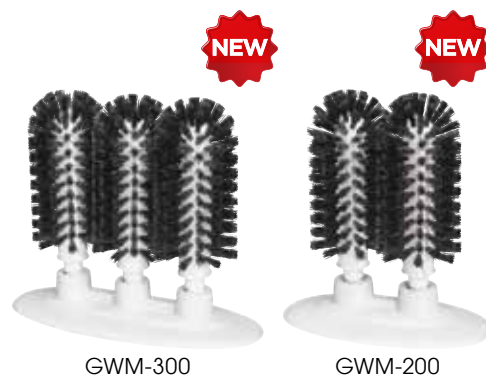

GLASS WASHER BRUSHES

- ◆ Four suction feet provide stability on slippery surfaces
- ◆ Dishwasher safe

ITEM	DESCRIPTION	UOM	CASE
GWB-3	3 Brushes with Base	Each	1/12
GWB-3-BR	Brush for GWB-3	Each	1/100



DECANTER CLEANING BRUSH

- ◆ Synthetic bristles effectively clean without scratching
- ◆ 1-1/4" diameter brush head

ITEM	DESCRIPTION	UOM	CASE
CDB-11	11" O.L.	Each	12/96



THIN & LONG CLEANING BRUSHES

- ◆ Designed for cleaning fryers, urns, and kettle valves

ITEM	DESCRIPTION	UOM	CASE
BR-24	24-1/2" L-Shaped Fryer Brush	Each	12/96
BR-25	25" Urn Brush	Each	12/96
BR-28	28-1/4" Kettle Valve Brush	Each	12/96

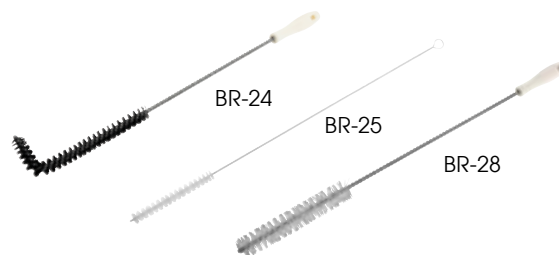

NYLON BRISTLE POT SCRUBBING BRUSHES

- ◆ Synthetic sturdy nylon bristles; plastic handle

ITEM	DESCRIPTION	UOM	CASE
BRN-8P	8" Nylon Brush	Each	12/72
BRN-20P	20" Nylon Brush	Each	12/72



COIR BRISTLE WOODEN HANDLE POT BRUSHES

- ◆ Natural coir bristles; wooden handle

ITEM	DESCRIPTION	UOM	CASE
BRP-10	10" Coir Brush	Each	12/72
BRP-20	20" Coir Brush	Each	6/48



GRILL MAINTENANCE



BR-27

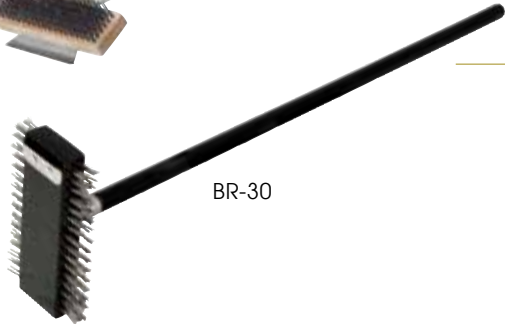

BR-30

PIZZA OVEN WIRE BRUSH WITH SCRAPER

- ◆ Carbon wire bristles with attached metal scraper
- ◆ Sturdy wooden handle

ITEM	DESCRIPTION	UOM	CASE
BR-27	Brush & Scraper w/27" Hdl	Each	12

PIZZA OVEN/BROILER WIRE BRUSH

- ◆ Stiff stainless steel wire bristles effortlessly clean heavy carbon deposits and oven residue

ITEM	DESCRIPTION	UOM	CASE
BR-30	Dbi-Side Brush w/30" Hdl	Each	8/32



BR-10



BR-36W



BR-60W

PIZZA OVEN WIRE BRUSH & HANDLES

- ◆ Brass wire bristles and metal scraper

ITEM	DESCRIPTION	UOM	CASE
BR-10	Brush & Scraper, 10-1/4" x 1-3/8" x 1-3/4"	Each	12/48
BR-36W	36" Wdn Hdl fits BR-10	Each	48
BR-60W	55" Wdn Hdl fits BR-10	Each	6/24



BR-31

COMMERCIAL BROILER WIRE BRUSH

- ◆ Steel bristles - 1-1/4"L wire
- ◆ Beechwood head - 7-11/16"L x 2-9/16"W x 1-1/16"H
- ◆ Zinc-plated metal handle; bent end provides leverage to reach and scrub

ITEM	DESCRIPTION	UOM	CASE
BR-31	31"L Brush & Zinc-Plated Hdl	Each	1/12



BR-21



DUAL-HEAD WIRE BRISTLE BRUSH

- ◆ Thin steel bristle brush side with 1-1/2" L wire
- ◆ Thick steel bristle brush side with 1-1/4" L flat wire
- ◆ Wire scrubbing head measures 7-3/4" wide x 2-5/8" deep x 7" high (wire to wire)
- ◆ Stainless steel handle with 20" long reach; 6" long bent end provides leverage to reach and scrub

ITEM	DESCRIPTION	UOM	CASE
BR-21	Dual Wire Brush with S/S Hdl	Each	6



BR-9

BUTCHER BLOCK WIRE BRUSH

- ◆ Stiff, steel wire bristles
- ◆ Sturdy handle to grip when scrubbing

ITEM	DESCRIPTION	UOM	CASE
BR-9	Butcher Block Wire Brush	Each	6/12



BR-12

OVEN & GRILL/BBQ WIRE BRUSH WITH METAL SCRAPER

- ◆ Brass wire bristles

ITEM	DESCRIPTION	UOM	CASE
BR-12	12"L Brush, Scraper & Handle	Each	12/72

HEAVY-DUTY ALUMINUM GRILL SCRAPER

- ◆ Sharp and wide 6" blade
- ◆ Use the top-grip to apply added pressure when removing grease & grime from flat-tops or griddles
- ◆ Splash-guard positioned above scraper blade deflects and helps collect debris for easy cleanup

ITEM	DESCRIPTION	BLADE	UOM	CASE
SCRP-14	16"L x 4-1/2"H	6"	Each	1/12
SCRP-6B	Replacement Blade for SCR-14, 6-Pcs/Pk		Pack	1/12

GRILL MAINTENANCE



ALUMINUM DUAL-HANDLE GRILL SCRAPER

- ◆ Scraper head is tilted downward to deflect splashing

ITEM	DESCRIPTION	BLADE	UOM	CASE
SCRP-16	16" Scraper	5"	Each	1/6
SCRP-5B	Replacement Blade for SCR-16		Each	12/48



ALUMINUM GRILL SCRAPER

- ◆ Reversible blade angled scraper great for removing stuck-on food

ITEM	DESCRIPTION	BLADE	UOM	CASE
SCRP-12	12" Alu Scraper	4"	Each	6/48
SCR-4B	Replacement Blades for SCR-12, 10-Pcs/Pk		Pack	10/400



BRICK & SCREEN GRILL CLEANERS

ITEM	DESCRIPTION	UOM	CASE
GSH-1	Grill Screen Holder, 5" x 2-3/4"	Each	12/48
GSN-4	Grill Screen, 4" x 5-1/2", 20-Pcs/Pk, Fits with GSH-1	Pack	20/80
GBH-2	Grill Brick Holder, 7" x 3-1/2"	Each	6/72
GBK-348	Grill Brick, 3-1/2" x 4" x 8", Fits with GBH-2	Doz	1

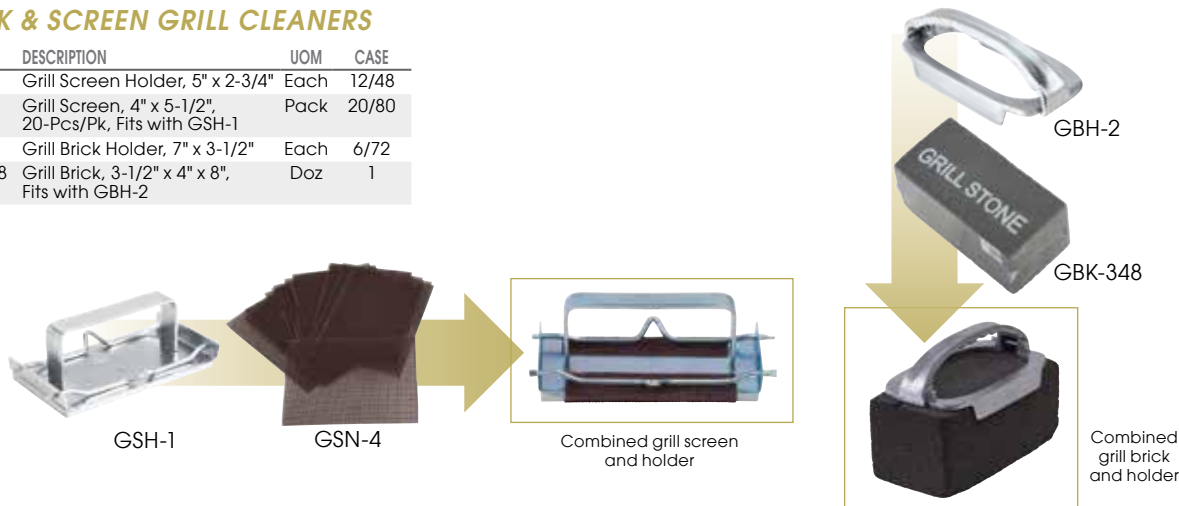

MINI UTILITY WIRE BRISTLE BRUSHES

- ◆ Ideal for cleaning ceramic tiles and narrow spaces

ITEM	DESCRIPTION	UOM	CASE
BR-7B	7" O.L., Brass Bristles	Each	48/576
BR-7S	7" O.L., S/S Wire Bristles	Each	48/576

UTILITY & SCRATCH BRUSHES



WIRE BRISTLE SCRATCH BRUSHES W/SCRAPER

ITEM	DESCRIPTION	UOM	CASE
BR-319	14" O.L., Steel Bristles	Doz	1/12
BR-500	20" O.L., Wire Bristles	Each	6/48

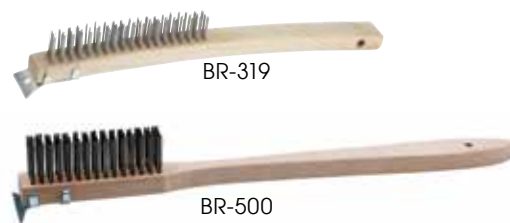

PUMP DISPENSER WITH 3 CAPACITY RESTRICTORS



PUMP DISPENSER WITH 3 RESTRICTORS SET

Dispense consistent amounts of hand sanitizer or hand soap, also great for condiments.

- ◆ 1-1/2" dia cap fits most 1 gallon jug
- ◆ Restricts to 1 oz, 3/4 oz, 1/2 oz, 1/4 oz capacities

ITEM	DESCRIPTION	UOM	CASE
PKT-1	17" O.L., Fits 1-1/2" Dia Opening	Set	12/72



STANCHION MOUNTS

- ◆ Stanchion mounts are designed to fit seamlessly with Winco stanchion posts (CGS-38K, -38S)



SMWH-5K

UNIVERSAL WIPES CONTAINER STANCHION MOUNT

- ◆ Mount fits most stanchion posts & CGS-series stanchions
- ◆ Designed to easily secure a container in place
- ◆ Holder size: 5-1/2" Dia x 5-1/2" H
- ◆ Designed to hold a sanitizing wipes container

ITEM	DESCRIPTION	UOM	CASE
SMWH-5K	Holder for Wipes Container	Each	6



SMSD-16K

UNIVERSAL HAND SANITIZER & SOAP DISPENSER STANCHION MOUNT

- ◆ Mount fits most stanchion posts & CGS-series stanchions
- ◆ Accommodates most sanitizer dispensers, including automatic units
- ◆ Designed to easily secure a dispenser in place
- ◆ Mount plate size: 6-3/4"W x 16-1/2"H
- ◆ Drip tray size: 7-1/2"W x 7-1/2"D

ITEM	DESCRIPTION	UOM	CASE
SMSD-16K	Holder for Universal Sanitizer/ Soap Dispenser	Each	6



SMJH-9K

UNIVERSAL JUG STANCHION MOUNT

- ◆ Mount fits most stanchion posts & CGS-series stanchions
- ◆ Accommodates 1 gallon jugs
- ◆ Designed to easily secure a jug in place
- ◆ Holder size: 7-1/4"W x 7-1/4"H

ITEM	DESCRIPTION	UOM	CASE
SMJH-9K	Holder for 1 Gallon Jug	Each	6

RESTROOM NECESSITIES

TWIN ROLLS TOILET TISSUE DISPENSER

- ◆ Fits two tissue paper rolls
- ◆ 4" wide compartment fits up to 9-1/2" diameter paper rolls

ITEM	DESCRIPTION	UOM	CASE
TD-220	Twin Roll Dispenser	Each	1/3



JUMBO ROLL PAPER DISPENSERS

- ◆ Fits one tissue paper roll

ITEM	DESCRIPTION	UOM	CASE
TD-120	One Roll Dispenser, 14"Dia	Each	1/3
TD-120S	One Roll Dispenser, 11"Dia	Each	1/6

CHROME-PLATED STEEL TOILET TISSUE HOLDERS

- ◆ Double or single roll

ITEM	DESCRIPTION	UOM	CASE
TTH-1	Single Roll	Each	1/36
TTH-2	Double Roll	Each	1/24

Paper roll not included



TOILET SEAT COVERS & DISPENSER

- ◆ Disposable covers fit over standard toilet seat
- ◆ 250 covers per bag
- ◆ Lightweight wall mount dispenser

ITEM	DESCRIPTION	UOM	CASE
TSC-10	Half-Fold Dispenser	Each	20
TSC-250	Half-Fold Covers, 250-Pcs/Bag	Bag	1/20



TOILET BRUSHES WITH PLASTIC HANDLE

- ◆ Non-scratch bristles

ITEM	DESCRIPTION	UOM	CASE
BR-15	15" O.L. Brush	Each	12/48
BR-15SET	15-3/4" O.L. Brush with Caddy	Set	1/24



ANGLED-TIP TOILET BRUSH WITH WOODEN HANDLE

- ◆ Longer reach helps reduce hunching over
- ◆ Angled tip of brush to clean under the rim

ITEM	DESCRIPTION	UOM	CASE
BR-21W	21" O.L.	Each	24

RUBBER PLUNGER WITH WOODEN HANDLE

- ◆ Long, smooth handle

ITEM	DESCRIPTION	UOM	CASE
TP-300	19" O.L.	Each	24

URINAL SCREEN

- ◆ Deodorizing odor protection

ITEM	DESCRIPTION	UOM	CASE
USF-7	Scented, 12pcs/pk	Pack	12



SOAP DISPENSERS



SDAL-1K
SDAF-1K



SDAL-1W
SDAF-1W



PUR-CLEAN™ AUTOMATIC SOAP DISPENSERS

- ◆ Touchless motion-sensor dispensing reduces cross-contamination
- ◆ 35 oz (1000ml) capacity
- ◆ Impact-resistant construction
- ◆ Liquid dispensers: use with liquid/gel soap or hand sanitizer
- ◆ Foam dispensers: use with foaming soap or hand sanitizer
- ◆ Wall mount

ITEM	DESCRIPTION	UOM	CASE
SDAL-1K	Liquid, Black	Each	12
SDAL-1W	Liquid, White	Each	12
SDAF-1K	Foam, Black	Each	12
SDAF-1W	Foam, White	Each	12

PUR-CLEAN™



SDML-1K
SDMF-1K



SDML-1W
SDMF-1W



PUR-CLEAN™ MANUAL SOAP DISPENSERS

- ◆ Large-easy press bar to push with hand or elbow to dispense
- ◆ 35 oz (1000 ml) capacity
- ◆ Impact-resistant construction
- ◆ Liquid dispensers: use with liquid/gel soap or hand sanitizer
- ◆ Foam dispensers: use with foaming soap or hand sanitizer
- ◆ Wall mount

ITEM	DESCRIPTION	UOM	CASE
SDML-1K	Liquid, Black	Each	24
SDML-1W	Liquid, White	Each	24
SDMF-1K	Foam, Black	Each	24
SDMF-1W	Foam, White	Each	24



SD-100K



SD-100

MANUAL BULK SOAP DISPENSERS

- ◆ 35 oz (1000ml) capacity
- ◆ Wall mount

ITEM	DESCRIPTION	UOM	CASE
SD-100K	Black	Each	1/24
SD-100	White	Each	1/24

AIR FRESHENER



AFD-1



AUTOMATIC AIR FRESHENER

- ◆ Fully programmable dispenser
- ◆ Sprays automatically at 5, 10, 15 or 30 minute intervals
- ◆ Working time setting options are day, night or 24 hours
- ◆ Fits standard size 6.6 oz refill sprays (not included)

ITEM	DESCRIPTION	UOM	CASE
AFD-1	White	Each	6/24

PAPER TOWEL DISPENSERS

PUR-CLEAN™ AUTO-CUT ROLL TOWEL DISPENSERS

- ◆ Mechanical hands-free dispensing; slim profile
- ◆ Automatically cuts consistent 9" sheets with each pull
- ◆ Fits most types of 7-7/8" paper towel rolls
- ◆ Impact-resistant construction

ITEM	DESCRIPTION	UOM	CASE
TDAC-8K	Black Hands-Free Dispenser	Each	3
TDAC-8W	White Hands-Free Dispenser	Each	3

PUR-CLEAN™



TDAC-8W



TDAC-8K

MULTI-FOLD PAPER TOWEL METAL DISPENSERS

- ◆ Fits 525 M-fold or 400 C-fold paper towels
- ◆ Fits 10-3/4"L x 3-1/4"W paper towel pack
- ◆ White is epoxy-coated
- ◆ No adjustments or adaptors required

ITEM	DESCRIPTION	UOM	CASE
TD-600	White M/C-Fold Dispenser	Each	1/6
TD-700	Stainless Steel M/C-Fold Dispenser	Each	1/6



TD-700



TD-600

MULTI-FOLD PAPER TOWEL DISPENSER

- ◆ Fits 200 C-fold or M-fold paper towels
- ◆ Fits 8-1/2" x 3-1/8" x 6" paper towel pack

ITEM	DESCRIPTION	UOM	CASE
TD-300	M/C-Fold Dispenser	Each	1/10



TD-300

CENTER-PULL PAPER TOWEL DISPENSER

- ◆ Fits 8" diameter paper roll

ITEM	DESCRIPTION	UOM	CASE
TD-330	Center-Pull Dispenser	Each	1/6



TD-330

LEVER HANDLE PAPER TOWEL DISPENSER

- ◆ Fits 8" diameter paper roll

ITEM	DESCRIPTION	UOM	CASE
TD-500	Lever Dispenser	Each	1/3



TD-500

HOOD FILTERS



Popular sizes
for food trucks!

STAINLESS STEEL HOOD FILTERS

Essential to any kitchen, these hood filters are durable and long-lasting, helping to prevent unsafe working conditions. Handles assist with easy installation and removal for cleaning. Install with baffles running vertically.

- ◆ 430 S/S, 26 gauge, 0.5mm thickness
- ◆ Clean with degreaser, soap and water, or in dishwasher

ITEM	DESCRIPTION	UOM	CASE
HFS-1616	16"W x 16"H	Each	1/6
HFS-1620	16"W x 20"H	Each	1/6
HFS-1625	16"W x 25"H	Each	1/6
HFS-2016	20"W x 16"H	Each	1/6
HFS-2020	20"W x 20"H	Each	1/6
HFS-2025	20"W x 25"H	Each	1/6
HFS-2520	25"W x 20"H	Each	1/6



HFS-1616



HFS-1625



HFS-2020



HFS-2025



HFS-2520

JANITORIAL ACCESSORIES



CAST ALUMINUM PAIL OPENER

- ◆ Handy for opening large buckets and pails
- ◆ Built-in hammer assists in closing lids for a tight seal



POA-8

ITEM	DESCRIPTION	UOM	CASE
POA-8	8-7/16"L x 2-3/4"W x 1-7/16"D	Each	6/72



SIK-3



STAINLESS STEEL SINK STRAINER

- ◆ Catch scraps while water/liquids drain through perforations

ITEM	DESCRIPTION	UOM	CASE
SIK-3	3"Dia w/Stopper	Each	24/144



RSB-6



Doubles as an in-sink
scrap catch or stopper

RUBBER SCRAP BLOCK

- ◆ Gather sink scraps for easy transport to the trash
- ◆ Also useful as a stopper on dish tables to block faucet hole when not in use and prevent leaking

ITEM	DESCRIPTION	UOM	CASE
RSB-6	6-1/2"Dia x 4"H	Each	12

BAR MAID® DRAIN TRAYS & EXTENSIONS

- ◆ Drain tray includes drain tube
- ◆ Use drain extensions with funnel or tray

ITEM	DESCRIPTION	UOM	CASE
CR-760	Drain Tray with Drain Tube, Black, 14"L x 5"W x 3"D	Each	1/12
CR-759	Replacement Drain Tube For Drain Tray	Each	1
CR-700	Superb Seal Bar Drain Extensions 8" Fits 1" To 1-3/8" Drain	Each	1/240
CR-701	Superb Seal Bar Drain Extensions 10" Fits 1-1/4" To 1-3/4" Drain	Each	1/144



DRAIN TRAYS & TRAPS



STANDARD SINK OVERFLOW PIPES

- ◆ Polypropylene with rubber cap for snug fit in sink drain
- ◆ Designed to keep water level below rim of 8" or higher sink, preventing spills - especially helpful in busy bar sinks

ITEM	DESCRIPTION	UOM	CASE
OP-7	7"L x 1"Dia	Each	24/288
OP-11	11"L x 1"Dia	Each	12/144

BAR MAID® FLY-BYE™ FLOOR DRAIN TRAP SEALS

- ◆ Patented one-way valve allows fluid to flow down without impeding flow rate and lets nothing come back up
- ◆ Makes drains virtually maintenance free
- ◆ Effectively stops fruit flies and insects from coming up
- ◆ Acts as a vapor barrier to keep bacteria, odors, and gases in the drain for improved indoor air quality
- ◆ No need to add primers and fresh water
- ◆ Pesticide-free, No VOCs

ITEM	DESCRIPTION	UOM	CASE
FB-TS20	For 2" Drain Pipes	Box	1/12
FB-TS30	For 3" Drain Pipes	Box	1/12
FB-TS35	For 3.5" Drain Pipes	Box	1/6
FB-TS40	For 4" Drain Pipes	Box	1/6



WIRE SECURITY CAGES

- ◆ NSF listed for use in dry storage and heated environments
- ◆ Heavy-duty wire construction
- ◆ Mix-and-match the various sizes to suit any need
- ◆ Easy to assemble, no tools required
- ◆ Capacities:
Under 48" long - up to 850 lbs/shelf,
Over 48" long - up to 600 lbs/shelf
- ◆ Includes 4 split-sleeve clips per shelf



NSF VC-SERIES SHELVES



CHROME-PLATED WIRE SHELVES

- ◆ Withstands temperatures from -100°F to 500°F
- ◆ **Must buy full case quantity**



ITEM	DESCRIPTION - W x L	UOM	CASE
VC-1424	14" x 24"	Each	2
VC-1430	14" x 30"	Each	2
VC-1436	14" x 36"	Each	2
VC-1448	14" x 48"	Each	2
VC-1460	14" x 60"	Each	2
VC-1472	14" x 72"	Each	2
VC-1824	18" x 24"	Each	2
VC-1830	18" x 30"	Each	2
VC-1836	18" x 36"	Each	2
VC-1842	18" x 42"	Each	2
VC-1848	18" x 48"	Each	2
VC-1854	18" x 54"	Each	2
VC-1860	18" x 60"	Each	2
VC-1872	18" x 72"	Each	2
VC-2124	21" x 24"	Each	2
VC-2130	21" x 30"	Each	2
VC-2136	21" x 36"	Each	2
VC-2148	21" x 48"	Each	2
VC-2160	21" x 60"	Each	2
VC-2172	21" x 72"	Each	2
VC-2424	24" x 24"	Each	2
VC-2430	24" x 30"	Each	2
VC-2436	24" x 36"	Each	2
VC-2442	24" x 42"	Each	2
VC-2448	24" x 48"	Each	2
VC-2454	24" x 54"	Each	2
VC-2460	24" x 60"	Each	2
VC-2472	24" x 72"	Each	2

Customize wire shelving to fit a variety of dry storage needs



NSF VC-SERIES POSTS



CHROME-PLATED POSTS

- ◆ For wire shelving
- ◆ Withstands temperatures from -100°F to 500°F
- ◆ **Must buy full case quantity**



ITEM	DESCRIPTION	UOM	CASE
VC-8P	8"H	Each	4
VC-34P	34"H	Each	4
VC-48P	48"H	Each	4
VC-54P	54"H	Each	4
VC-63P	63"H	Each	4
VC-72P	72"H	Each	4
VC-86P	86"H	Each	4



VCB-SERIES

CHROME-PLATED WALL MOUNT BRACKETS

- ◆ A great option for mounting a single wire shelf to the wall with two brackets
- ◆ **Must buy full case quantity**

ITEM	DESCRIPTION	UOM	CASE
VCB-14	14"W	Pair	2
VCB-18	18"W	Pair	2
VCB-21	21"W	Pair	2
VCB-24	24"W	Pair	2



VC-HK

S/N-STYLE HOOK FOR CHROME-PLATED SHELVING

- ◆ Holds shelving units together when standing next to or behind each other

ITEM	DESCRIPTION	UOM	CASE
VC-HK	S/N Hook for VC-series Shelves	Each	20/200



EPOXY-COATED WIRE SHELVES

◆ Withstands temperatures from -100°F to 500°F

◆ **Must buy full case quantity**

ITEM	DESCRIPTION - W x L	UOM	CASE
VEX-1424	14" x 24"	Each	2
VEX-1430	14" x 30"	Each	2
VEX-1436	14" x 36"	Each	2
VEX-1448	14" x 48"	Each	2
VEX-1460	14" x 60"	Each	2
VEX-1472	14" x 72"	Each	2
VEX-1824	18" x 24"	Each	2
VEX-1830	18" x 30"	Each	2
VEX-1836	18" x 36"	Each	2
VEX-1842	18" x 42"	Each	2
VEX-1848	18" x 48"	Each	2
VEX-1854	18" x 54"	Each	2
VEX-1860	18" x 60"	Each	2
VEX-1872	18" x 72"	Each	2
VEX-2124	21" x 24"	Each	2
VEX-2130	21" x 30"	Each	2
VEX-2136	21" x 36"	Each	2
VEX-2148	21" x 48"	Each	2
VEX-2160	21" x 60"	Each	2
VEX-2172	21" x 72"	Each	2
VEX-2424	24" x 24"	Each	2
VEX-2430	24" x 30"	Each	2
VEX-2436	24" x 36"	Each	2
VEX-2442	24" x 42"	Each	2
VEX-2448	24" x 48"	Each	2
VEX-2454	24" x 54"	Each	2
VEX-2460	24" x 60"	Each	2
VEX-2472	24" x 72"	Each	2

Epoxy shelving suitable for storage in dry as well as moist/humid areas

WIRE SHELVES

- ◆ NSF listed for use in all environments, including humid areas
- ◆ Heavy-duty wire construction
- ◆ Mix-and-match the various sizes to suit any need
- ◆ Easy to assemble, no tools required
- ◆ Capacities:
Under 48" long - up to 850 lbs/shelf,
Over 48" long - up to 600 lbs/shelf
- ◆ Includes 4 split-sleeve clips per shelf

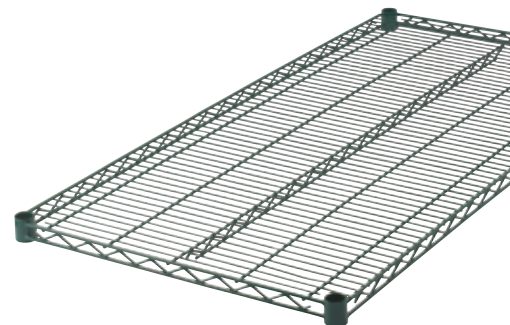

VEX-SERIES SHELVES



EPOXY-COATED POSTS

- ◆ For wire shelving
- ◆ Withstands temperatures from -100°F to 500°F

◆ **Must buy full case quantity**

ITEM	DESCRIPTION	UOM	CASE
VEX-8P	8"H	Each	4
VEX-34P	34"H	Each	4
VEX-48P	48"H	Each	4
VEX-54P	54"H	Each	4
VEX-63P	63"H	Each	4
VEX-72P	72"H	Each	4
VEX-86P	86"H	Each	4



VEX-SERIES POSTS



EPOXY-COATED WALL MOUNT BRACKETS

- ◆ A great option for mounting a single wire shelf to the wall with two brackets

◆ **Must buy full case quantity**

ITEM	DESCRIPTION	UOM	CASE
VEXB-14	14"W	Pair	2
VEXB-18	18"W	Pair	2
VEXB-21	21"W	Pair	2
VEXB-24	24"W	Pair	2

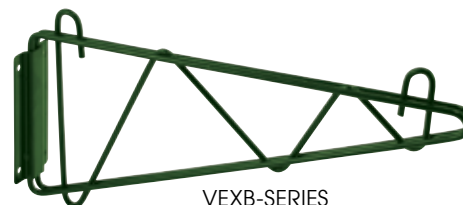

VEXB-SERIES

S/N-STYLE HOOK FOR EPOXY-COATED SHELVING

- ◆ Holds shelving units together when standing next to or behind each other

ITEM	DESCRIPTION	UOM	CASE
VEX-HK	S/N Hook for VEX-series Shelves	Each	20/200



VEX-HK



WIRE SECURITY CAGES



CHROME-PLATED SECURITY CAGES

◆ 63" high panels at varying lengths and widths



ITEM	DESCRIPTION	UOM	CASE
VCG-1836	18 x 36 x 63"H	Set	1
VCG-1848	18 x 48 x 63"H	Set	1
VCG-1860	18 x 60 x 63"H	Set	1
VCG-2436	24 x 36 x 63"H	Set	1
VCG-2448	24 x 48 x 63"H	Set	1
VCG-2460	24 x 60 x 63"H	Set	1

- ◆ NSF listed for use in dry storage and heated environments
- ◆ Withstands temperatures from -100°F to 500°F
- ◆ Heavy-gauge chrome-plated wire
- ◆ Reinforced wire ends and hinges, & continuous bar wraps corners and across sides for optimal strength and security
- ◆ Secure locking mechanisms
- ◆ Easy to assemble - wider panels come pre-connected and ready to attach
- ◆ For use with casters: use with 63" high posts
- ◆ For non-mobile: use with 72" high posts
- ◆ *Shelves, posts, casters sold separately*

Sets include 2 doors, 2 side panels, & 2-piece hinged back panel



Locking bar secures door when closed.

Shown assembled with chrome wire shelves and posts

Customize with Winco chrome wire shelving and posts



Wire hook-n-loop door and side panels for extra security.



Pin on door locks into top and bottom shelves.

Triple-wire anti-pry reinforcement adjacent to thick locking bar.



Protective cover on exposed wire ends.



Panels pre-connected with heavy wire loops, no assembly required.



Panel clips into shelf for secure, tight fit.

- ◆ Shelving set includes (4) shelves and (4) 72" high posts
- ◆ Heavy-duty wire construction
- ◆ Easy to assemble, no tools required
- ◆ Withstands temperatures from -100°F to 500°F
- ◆ Capacity: up to 1,400lbs per set

WIRE SHELVING SETS



VCS-SERIES NSF



CHROME-PLATED WIRE SHELVING SET

- ◆ NSF listed for use in dry storage and heated environments

ITEM	DESCRIPTION	UOM	CASE
VCS-1836	18"W x 36"L	Set	1
VCS-1848	18"W x 48"L	Set	1
VCS-2436	24"W x 36"L	Set	1
VCS-2448	24"W x 48"L	Set	1



EPOXY-COATED WIRE SHELVING SET

- ◆ NSF listed for use in all environments, including humid areas

ITEM	DESCRIPTION	UOM	CASE
VEXS-1836	18"W x 36"L	Set	1
VEXS-1848	18"W x 48"L	Set	1
VEXS-2436	24"W x 36"L	Set	1
VEXS-2448	24"W x 48"L	Set	1



VEXS-SERIES NSF



3-TIER WIRE SHELVING CARTS

Customizable height to fit a variety of storage needs.

- ◆ Includes 3 adjustable-height wire shelves
- ◆ Capacity up to 800lbs
- ◆ Step-lock feature on two casters
- ◆ Ships knocked down

ITEM	DESCRIPTION	UOM	CASE
VCCD-1836B	18"W x 36"L x 42"H	Set	1
VCCD-2448B	24"W x 48"L x 42"H	Set	1

WIRE SHELVING CARTS



VCCD-1836B

MOBILE SHELVING EXTENSION HANDLES

- ◆ Use extension handles on mobile units for easy transport
- ◆ Includes 2 sleeve clips per handle

ITEM	DESCRIPTION	UOM	CASE
VCH-14	14"W	Each	2/12
VCH-18	18"W	Each	2/12
VCH-21	21"W	Each	12
VCH-24	24"W	Each	2/12



VCH-14



VCH-24



SHELVING PARTS & ACCESSORIES



VC-LF



VC-SC2

PARTS FOR WIRE SHELVING

- ◆ Secure shelving to floors
- ◆ Each pack contains four (4) pieces

ITEM	DESCRIPTION	UOM	CASE
VC-LF	Shelf Leveling Foot	Pack	1/100
VC-SC2	Shelf Sleeve Clips	Pack	100



VC-FP

SHELVING FOOT PLATE

- ◆ Secure stationary shelving units to the floor
- ◆ Each pack contains four (4) pieces

ITEM	DESCRIPTION	UOM	CASE
VC-FP	Foot Plate w/Screws	Pack	1/100



VC-CT



VC-CTB

CASTERS FOR WIRE SHELVING

- ◆ 5" diameter

ITEM	DESCRIPTION	UOM	CASE
VC-CT	Caster	Each	4/24
VC-CTB	Casters with Brake	Each	4/24

DUNNAGE RACKS



ASDR-1424



ASDR-2036

NSF ASDR-SERIES



ADRK-2036



ADRK-2060

NSF ADRK-SERIES

ALUMINUM DUNNAGE RACKS

- ◆ Elevate items off the floor
- ◆ 8" or 12" high
- ◆ Sturdy square tube construction

ITEM	DESCRIPTION	W x L	HT	UOM	CASE
ASDR-1424	Holds up to 1200 Lbs	14" x 24"	8"	Each	8
ASDR-1436	Holds up to 900 Lbs	14" x 36"	8"	Each	6
ASDR-1448	Holds up to 900 Lbs	14" x 48"	8"	Each	6
▶ ASDR-2036	Holds up to 1800 Lbs	20" x 36"	8"	Each	6
▶ ASDR-2048	Holds up to 1500 Lbs	20" x 48"	8"	Each	6
▶ ASDR-2060	Holds up to 1200 Lbs	20" x 60"	8"	Each	6
▶ ADRK-2036	Holds up to 1800 Lbs	20" x 36"	12"	Each	6
▶ ADRK-2048	Holds up to 1500 Lbs	20" x 48"	12"	Each	6
▶ ADRK-2060	Holds up to 1200 Lbs	20" x 60"	12"	Each	6

CAN STORAGE RACKS

HEAVY-DUTY ALUMINUM CAN STORAGE RACKS

The can racks are designed with angled shelves for first-in first-out stock rotation.

- ◆ Sturdy aluminum construction
- ◆ Designed to hold #10 or #5 cans
- ◆ First-in, first-out design for proper stock rotation
- ◆ Angled shelves with lifted front edges prevent cans from rolling out; loads from front or rear

Fits standard #10 and #5 cans



ALCR-9 NSF

STATIONARY CAN STORAGE RACK

- ◆ 9-tier sturdy aluminum construction
- ◆ Holds up to (162) #10 cans or (216) #5 cans
- ◆ 7" spacing between each tier
- ◆ Ships knocked down
- ◆ Fully assembled dimensions: 26-3/8"L x 34-3/4"W x 82-1/8"H

Capacity up to 1,200 Lbs

ITEM	DESCRIPTION	UOM	CASE
ALCR-9	9-Tier, Knocked Down	Each	1



Sturdy cross-braces



Reinforced frame, stainless steel levelers



Tiers slant forward and raised edges prevent cans from rolling out

MOBILE UNDER-COUNTER CAN STORAGE RACK

- ◆ 3-tier sturdy aluminum construction
- ◆ Holds up to (36) #10 or (45) #5 cans
- ◆ Heavy gauge aluminum worktop
- ◆ 3" swivel casters for mobility, 2 with brake
- ◆ Fully assembled dimensions: 26-3/4"L x 25-1/2"D x 33-1/2"H

ITEM	DESCRIPTION	UOM	CASE
ALCR-3M	3-Tier	Each	1



Tiers slant forward and raised edges prevent cans from rolling out



ALCR-3M NSF



Winco's exclusive Weld2 System features fail-safe rigidity through both bolting and welding at all critical joints to prevent warping with long term, high-traffic use.



Specialty bolts secure each joint

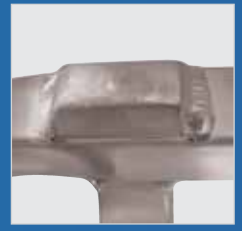

Bolt caps are welded over completely to form extra-strength juncture

HEAVY-DUTY ALUMINUM 20-TIER SHEET PAN RACK

Capacity up to 1,000 Lbs

Fully welded



Double crossbars for extra strength



NSF AWRK-20HBK

HEAVY DUTY 20-TIER END-LOAD SHEET PAN RACK, WITH BRAKES

Designed with heavy-duty welded construction and a reinforced base-frame to ensure stability and long-lasting performance.

- ◆ 20-tier sturdy aluminum construction
- ◆ Designed to hold and transport (20) full-size (18" x 26") sheet pans or 40 (13" x 18") half-size sheet pans
- ◆ 5" dia, full-swivel casters; two (2) with brake
- ◆ Capacity: up to 1,000 Lbs
- ◆ 3" spacing between each tier
- ◆ Fully assembled dimensions: 21-3/4"L x 26"W x 70-1/2"H

ITEM	DESCRIPTION	UOM	CASE
AWRK-20HBK	20-Tier, Welded	Each	1
AWRC-5H	Caster for AWRK-20HBK, Heavyweight	Each	12
AWRC-5HK	Caster w/Brake for AWRK-20HBK, Heavyweight	Each	12



AWRC-5HK 5" plate caster with brake

Refer to Bakeware for full range of sheet pans



UNIVERSAL CASTERS

Raises racks by 6"



CT-1



CT-1B



CT-23



CT-23B



CT-33



CT-33B



CT-44



CT-44B

UNIVERSAL CASTERS, EXTRA HEAVY-DUTY

- ◆ Use with most appliances including ranges or walk-in refrigerators
- ◆ Polyurethane, skid-free - will not mark floors
- ◆ High-quality grease-resistant wheel
- ◆ Temperature range from 14°F to 212°F
- ◆ Wheel capacity: 220 lbs each
- ◆ CT-1 and CT-1B fit standard 1-5/8" or 1-1/2" tubing
- ◆ 2 pieces per set

ITEM	DESCRIPTION	PLATE SIZE	UOM	CASE
CT-1	Worktable Stem Caster Set		Set	1/12
CT-1B	Worktable Stem Caster Set w/Brake		Set	1/12
CT-23	Universal Plate Caster Set	2-3/8" x 3-5/8"	Set	1/12
CT-23B	Universal Plate Caster Set w/ Brake	2-3/8" x 3-5/8"	Set	1/12
CT-33	Universal Plate Caster Set	3-1/2" x 3-1/2"	Set	1/12
CT-33B	Universal Plate Caster Set w/ Brake	3-1/2" x 3-1/2"	Set	1/12
CT-44	Universal Plate Caster Set	4" x 4"	Set	1/12
CT-44B	Universal Plate Caster Set w/Brake	4" x 4"	Set	1/12

Made for the most demanding restaurant kitchens, these aluminum sheet pan racks accommodate standard full-size 18" x 26" sheet pans, or twice the capacity with half-size 18" x 13" pans.

ALUMINUM SHEET PAN RACKS



10-TIER SHEET PAN RACKS

- ◆ Sturdy aluminum construction
- ◆ Hold and transport 10 full-size (18" x 26") sheet pans
- ◆ 5" dia, full-swivel casters; two (2) with brake
- ◆ Capacity: up to 400 Lbs
- ◆ 3" spacing between each tier
- ◆ Ships welded or knocked down
- ◆ Fully assembled dimensions: 21"L x 26-1/2"D x 39"H

ITEM	DESCRIPTION	UOM	CASE
AWRK-10	10-Tier, Welded	Each	1
ALRK-10BK	10-Tier, Knocked Down	Each	1
ALRK-10	10-Tier w/o Brakes, Knocked Down	Each	1
ALRC-5ST	Caster for ALRK and AWRK-series	Each	12
ALRC-5STK	Caster w/Brake for ALRK & AWRK-series	Each	12



AWRK-10
ALRK-10BK NSF

ALRK-10 NSF

20-TIER END-LOAD SHEET PAN RACKS

- ◆ Sturdy aluminum construction
- ◆ Hold and transport 20 full-size (18" x 26") sheet pans
- ◆ 5" dia, full-swivel casters; two (2) with brake
- ◆ Capacity (ALRK-20R): up to 500 Lbs
- ◆ Capacity (ALRK-20 & ALRK-20BK): up to 700 Lbs
- ◆ Capacity (AWRK-20): up to 800 Lbs
- ◆ 3" spacing between each tier
- ◆ Ships welded or knocked down
- ◆ Fully assembled dimensions (ALRK-20, -20BK, AWRK-20): 21"L x 26-1/2"W x 70"H
- ◆ Fully assembled (ALRK-20R): 20-1/4"L x 26"W x 69-1/4"H

ITEM	DESCRIPTION	UOM	CASE
AWRK-20	20-Tier, Welded	Each	1
ALRK-20BK	20-Tier, Knocked Down	Each	1
ALRK-20	20-Tier w/o Brakes, Knocked Down	Each	1
ALRK-20R	20-Tier, Knocked Down, ECONOMY	Each	1
ALRC-5ST	Caster for ALRK-20/-20BK & AWRK-20	Each	12
ALRC-5STK	Caster w/Brake for ALRK-20/-20BK & AWRK-20	Each	12
ALRC-5R	Caster for ALRK-20R	Each	12
ALRC-5RK	Caster w/Brake for ALRK-20R	Each	12



ALRK-20 NSF

AWRK-20
ALRK-20BK NSF

30-TIER END-LOAD SHEET PAN RACKS, WITH BRAKES

- ◆ Aluminum construction, 14 gauge
- ◆ Hold and transport 30 full-size (18" x 26") sheet pans
- ◆ 5" dia, heavyweight full-swivel casters; two (2) with brake
- ◆ Capacity: up to 700 Lbs
- ◆ 2" spacing between each tier
- ◆ Ships welded or knocked down
- ◆ Fully assembled dimensions: 21"L x 26-1/2"D x 70"H

ITEM	DESCRIPTION	UOM	CASE
AWRK-30	30-Tier, Welded	Each	1
ALRK-30BK	30-Tier, Knocked Down	Each	1
ALRC-5H	Caster for ALRK-30BK, Heavyweight	Each	12
ALRC-5HK	Caster w/Brake for ALRK-30BK, Heavyweight	Each	12



AWRK-30 NSF

ALRK-30BK NSF

ALUMINUM NESTING SHEET PAN RACKS

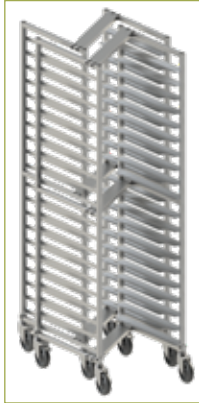

Empty racks nested together

NSF ALZK-20BK
AWZK-20

20-TIER NESTING RACK, WITH BRAKES

Designed with space-saving in mind, the Z-rack fits snugly with nesting racks to conserve floor space while in storage. The Z-rack accommodates standard full-size sheet pans, or double up with half-size pans.

- ◆ 20-tier sturdy aluminum construction
- ◆ Z-frame nesting design for compact storage
- ◆ Capacity: up to 650 lbs & 20 full-size (18" x 26") sheet pans
- ◆ Full-swivel casters; two (2) with brake
- ◆ 3" spacing between each tier
- ◆ Fully assembled: 22" L x 27-1/2"W x 70"H

ITEM	DESCRIPTION	UOM	CASE
AWZK-20	20-Tier, Welded	Each	1
ALZK-20BK	20-Tier, Knocked Down	Each	1
ALRC-5ST	Caster for ALZK & AWZK-series	Each	12
ALRC-5STK	Caster w/Brake for ALZK & AWZK-series	Each	12

ALUMINUM SIDE-LOAD SHEET PAN RACKS



20-TIER SIDE-LOAD RACK, WITH BRAKES

Designed with side-load access for alternative convenience in tight kitchen and bakery spaces.

- ◆ 20-tier sturdy aluminum construction
- ◆ Designed to hold and transport (20) full-size (18" x 26") sheet pans
- ◆ 5" dia, full-swivel casters; two (2) with brake
- ◆ Capacity: up to 650 Lbs
- ◆ 3" spacing between each tier
- ◆ Ships welded or knocked down
- ◆ Fully assembled dimensions: 29-1/2"L x 19-1/2"W x 70-3/8"H

ITEM	DESCRIPTION	UOM	CASE
AWRS-20BK	20-Tier, Welded	Each	1
ALRS-20BK	20-Tier, Knocked Down	Each	1
ALRC-5ST	Caster for ALZK & AWZK-series	Each	12
ALRC-5STK	Caster w/Brake for ALZK & AWZK-series	Each	12

NSF ALRS-20BK
AWRS-20BK

26-TIER PIZZA PAN RACK, WITH BRAKES

Each tier features an extended ledge to accommodate round or square pizza pans.

- ◆ 26-tier sturdy aluminum construction
- ◆ Designed to hold and transport 17" & 19" dia round pizza pans and 16" & 17" square Sicilian pizza pans
- ◆ 5" dia, full-swivel casters; two (2) with brake
- ◆ Capacity: up to 800 Lbs
- ◆ 2" spacing between each tier
- ◆ 4-1/8" wide ledge for round or square pizza pans
- ◆ Ships welded or knocked down
- ◆ Fully assembled dimensions: 23"L x 21"W x 62-7/8"H

ITEM	DESCRIPTION	UOM	CASE
AWPR-26BK	26-Tier, Welded	Each	1
ALPR-26BK	26-Tier, Knocked Down	Each	1
ALRC-5ST	Caster for ALZK & AWZK-series	Each	12
ALRC-5STK	Caster w/Brake for ALZK & AWZK-series	Each	12



ALRC-5STK
5" caster with brake

ALUMINUM PIZZA PAN RACKS



ALPR-26BK
AWPR-26BK

ALUMINUM COUNTER-HEIGHT END-LOAD SHEET PAN RACK

- ◆ 15 plated steel wire slides at 1-3/4" spacing
- ◆ Stainless steel solid top is useful as a work surface, and can also help to transport bulky items
- ◆ 14 gauge 6063 aluminum with 1" extruded tube frame
- ◆ Full swivel casters, 5" diameter x 1-1/4"
- ◆ Holds 15 full-size (18" x 26") or 30 half-size (18" x 13") sheet pans (not included)
- ◆ Capacity: up to 400 lbs
- ◆ Ships knocked down
- ◆ Fully assembled: 20-7/8"L x 26-1/8"W x 31-5/8"H

ITEM	DESCRIPTION	UOM	CASE
ALRK-15	15-Tier	Each	1
ALRC-5ST	Caster for ALRK and AWRK-series	Each	12
ALRC-5STK	Caster w/Brake for ALRK & AWRK-series	Each	12

ALUMINUM SHEET PAN RACK & TRUCK



ALRK-15

ALUMINUM SHEET PAN TRUCK

- ◆ 14 gauge 6063 aluminum with 1" extruded aluminum tube frame
- ◆ Full swivel casters, 5" diameter x 1-1/4" width
- ◆ Holds 54 full-size (18" x 26") or 108 half-size (13" x 18") sheet pans (not included)
- ◆ Ships knocked down
- ◆ Fully assembled: 28-7/8"L x 20-5/8"W x 33-3/8"H

ITEM	DESCRIPTION	UOM	CASE
ALRK-3	Sheet Pan Truck	Each	1
ALRC-5P	Replacement Caster for ALRK-3	Each	12



ALRK-3

**STAINLESS STEEL
STEAM TABLE PAN/
FOOD PAN RACKS**



Capacity up to 1,000 lbs

STAINLESS STEEL STEAM TABLE PAN/FOOD PAN RACKS

- ◆ Stainless steel construction
- ◆ Customize with a variety of steam table pans and food pans for the best configuration
- ◆ Dual-ended locking bars prevent pans from sliding out
- ◆ Caster bumpers protect walls, doors and rack during minor collisions
- ◆ Channel ledges are tightly welded to rails providing better support for pans
- ◆ 4" dia double-bearing, full-swivel casters help stabilize weight capacity
- ◆ Capacities: up to 1,000 Lbs (SRK-36) or up to 500 Lbs (SRK-12, SRK-12D)
- ◆ Ships knocked down
- ◆ 1-1/2" and 1-3/4" spacing between each tier

FULL HEIGHT RACKS - 36-TIER

ITEM	DESCRIPTION	SIZE	UOM	CASE
SRK-36	36-Tier END-LOAD Rack	15-1/8"L x 21-5/8"W x 63-1/4"H	Each	1

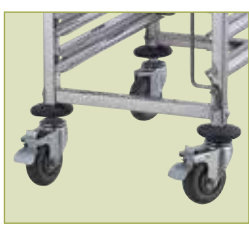

Caster bumpers protect walls, doors and rack against minor collisions

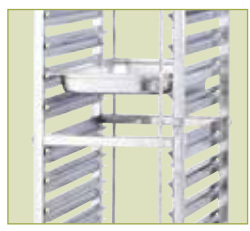

Customize with a variety of steam table pans and food pans for the best configuration

UNDER-COUNTER RACKS - 12-TIER

ITEM	DESCRIPTION	SIZE	UOM	CASE
SRK-12	12-Tier END-LOAD Rack	15-1/8"L x 21-5/8"W x 31-1/2"H	Each	1
SRK-12D	12-Tier SIDE-LOAD Rack	23-1/4"L x 26"W x 31-1/2"H	Each	1



SRK-12
Fits a combination of full, half or third-size pans



SRK-12D
Fits full length pans only, two per tier

Refer to Steam Table Pans for full range of food pans

REPLACEMENT CASTERS

ITEM	DESCRIPTION	UOM	CASE
SRK-CT	Caster for SRK-Series	Each	4/16
SRK-CTB	Caster w/Brake for SRK-Series	Each	4/16



SRK-CT
4" castor



SRK-CTB
4" castor with brake

SHEET PAN RACK COVERS

ITEM	DESCRIPTION	UOM	CASE
ALRK-10-CV	Cover for 10-Tier Rack, 25"W x 28"D x 33-1/2"H	Each	1/12
ALRK-20-CV	Cover for 20-Tier and 30-Tier Racks, 25"W x 28"D x 61-1/2"H	Each	1/12
ALRK-20-HC	Cover 23"W x 28"D x 62"H, Heavy-Duty, w/Window	Each	1/12



Clear-view vinyl, zipper closure

ALRK-10-CV



Opaque white vinyl, clear-view window, zipper closure



ALRK-20-HC

SHEET PAN RACK REPLACEMENT CASTERS

ITEM	DESCRIPTION	UOM	CASE
ALRC-5P	Caster for ALRK-3	Each	12
ALRC-5ST	Caster for ALRK & AWRK-series	Each	12
ALRC-5STK	Caster w/Brake for ALRK & AWRK-series	Each	12
ALRC-5R	Caster for ALRK-20R	Each	12
ALRC-5RK	Caster w/Brake for ALRK-20R	Each	12
ALRC-5H	Caster for ALRK-30BK, Heavyweight	Each	12
ALRC-5HK	Caster w/Brake for ALRK-30BK, Heavy-duty	Each	12
AWRC-5H	Caster for AWRK-20HBK, Heavy-duty	Each	12
AWRC-5HK	Caster w/Brake for AWRK-20HBK, Heavy-duty	Each	12
SRK-CT	Caster for SRK-36	Each	4/16
SRK-CTB	Caster w/ Brake for SRK-36	Each	4/16



ALRC-5P

ALRC-5ST

ALRC-5STK

ALRC-5H



ALRC-5RK

ALRC-5HK



AWRC-5HK

SRK-CTB

RACK ITEM NUMBER

	CASTER ITEM NUMBER												
	ALRC-5P	ALRC-5ST	ALRC-5STK	ALRC-5E	ALRC-5EK	ALRC-5H	ALRC-5HK	ALRC-5K	ALRC-5RK	AWRC-5H	AWRC-5HK	SRK-CT	SRK-CTB
ALPR-26BK		2	2										
ALRK-10/20		4											
ALRK-10BK/15/20BK		2	2										
ALRK-20R				2	2			2	2				
ALRK-3	4												
ALRK-30BK						2	2						
ALRS-20BK		2	2										
ALZK-20BK		2	2										
AWPR-26BK		2	2										
AWRK-10/20		2	2										
AWRK-20HBK									2	2			
AWRS-20BK		2	2										
AWZK-20		2	2										
SRK-12/12D/36												2	2

WINCO EXCLUSIVE WIRE DOUGH BOX DOLLY

Transport multiple dough boxes with ease using this wire dolly, currently the only one on the market!

- ◆ Capacity: up to 400 lbs
- ◆ 3-3/4" wheels

ITEM	DESCRIPTION	UOM	CASE
DWR-2617	27"L x 18-1/4"W x 2-1/2"H	Each	1
DWR-CT	Caster for DWR-2617	Each	4/24
DWR-CTB	Caster w/ Brake for DWR-2617	Each	4/24

Refer to Bakeware for dough boxes

WIRE DOLLY



DWR-2617



FLATWARE ORGANIZERS



FC-PL

Perforations promote air circulation



Notched lip to easily remove from holder



FC-SS



FC-SL

NSF FC-SERIES

FLATWARE/CUTLERY CYLINDERS & HOLDERS

◆ Items FC-PL / -SS / -SL fit into 4" diameter hole

ITEM	DESCRIPTION	UOM	CASE
FC-PL	Perforated, Plastic	Each	36/144
FC-SS	Perforated, S/S	Each	20/80
FC-SL	Solid, S/S	Each	20/80
FC-4H	4-Holes/2-Tier Holder, S/S	Each	1/4
FC-6H	6-Holes/2-Tier Holder, S/S	Each	1/2



FC-4H with FC-PL



FC-6H with FC-PL

FLATWARE/CUTLERY COMPARTMENT BINS

ITEM	DESCRIPTION	UOM	CASE
PL-4B	Plastic	Each	1/12
SCB-4	Stainless Steel	Each	1/8



BPA FREE PL-4B



SCB-4

FLATWARE/CUTLERY ORGANIZERS

ITEM	DESCRIPTION	UOM	CASE
OGZ-6	Organizer Bin Set	Set	1
OGZ-1B	Single Bin for OGZ-6	Each	6



OGZ-6



OGZ-1B

FLATWARE/CUTLERY DISHWASHER BASKET

◆ 8 compartments, molded-in handles

ITEM	DESCRIPTION	UOM	CASE
PCB-8	17" x 8" x 6"	Each	12



NSF PCB-8

GRAY POLYPROPYLENE LUG BOX

- ◆ Containers can nest together, stack across each other and stack with lids on

ITEM	DESCRIPTION	UOM	CASE
PL-8	24" x 15" x 8"	Each	1
PL-8C	Cover	Each	12

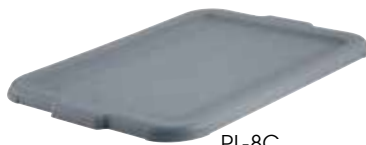

PL-8C

DISH/BUS BOXES

Conveniently nest together



Stackable



PL-8

PL-SERIES

HEAVYWEIGHT POLYPROPYLENE DISH BOXES

- ◆ Larger, thicker and stronger than standard dish boxes
- ◆ Freezer safe

ITEM	DESCRIPTION	COLOR	UOM	CASE
PLW-7G	21" x 17" x 7"	Gray	Each	1
PLW-7K	21" x 17" x 7"	Black	Each	1
PLW-7W	21" x 17" x 7"	White	Each	1
PLW-CG	Cover	Gray	Each	12
PLW-CK	Cover	Black	Each	12
PLW-CW	Cover	White	Each	12



PLW-7W



PLW-7K



PLW-7G

PLW-SERIES

HEAVYWEIGHT POLYPROPYLENE PERFORATED BUS BOXES

- ◆ Drains easily to eliminate excess water
- ◆ Ideal for thawing food

ITEM	DESCRIPTION	COLOR	UOM	CASE
PLP-5G	21-1/4" x 15-3/8" x 4-7/8"	Gray	Each	1
PLP-5W	21-1/4" x 15-3/8" x 4-7/8"	White	Each	1



PLP-5W



Perforated Base

PLP-SERIES

STANDARD POLYPROPYLENE DISH BOXES

ITEM	DESCRIPTION	COLOR	UOM	CASE
PL-5G	20-1/4" x 15-1/2" x 5"	Gray	Each	1
PL-5K	20-1/4" x 15-1/2" x 5"	Black	Each	1
PL-5W	20-1/4" x 15-1/2" x 5"	White	Each	1
PL-7G	21-1/2" x 15" x 7"	Gray	Each	1
PL-7B	21-1/2" x 15" x 7"	Brown	Each	1
PL-7K	21-1/2" x 15" x 7"	Black	Each	1
PL-7W	21-1/2" x 15" x 7"	White	Each	1
PL-57C	Cover	Gray	Each	1/12
PL-57B	Cover	Brown	Each	1/12
PL-57K	Cover	Black	Each	1/12
PL-57W	Cover	White	Each	1/12



PL-SERIES

HEAVYWEIGHT POLYPROPYLENE DIVIDED BUS BOXES

- ◆ Two (2) compartments
- ◆ Economical storage for heavy loads
- ◆ Rounded corners for easy cleaning

ITEM	DESCRIPTION	COLOR	UOM	CASE
PLTC-7G	21" x 16-3/4" x 6-1/2"	Gray	Each	1
PLTC-7K	21" x 16-3/4" x 6-1/2"	Black	Each	1



PLTC-7K

PLTC-SERIES

WHITE POLYPROPYLENE MINI BIN

ITEM	DESCRIPTION	UOM	CASE
PL-MB	14-3/4" x 12-1/2" x 5-3/8"	Each	24
PL-MBC	Cover	Each	24



PL-MB-SERIES

UTILITY & BUS CARTS

4 swivel casters, 2 with brakes



UC-2415G



UC-3019K

3-TIER UTILITY CARTS WITH BRAKES

- ◆ Easy-clean polypropylene shelves
- ◆ UC-2415 series weighs 17.5 lbs
- ◆ UC-3019 series weighs 27 lbs
- ◆ Accessory bins sold separately
- ◆ Ships knocked down

ITEM	DESCRIPTION	CAPACITY	COLOR	UOM	CASE
UC-2415G	32"L x 16-1/8"W x 36-3/4"H	330 Lbs	Gray	Set	1
UC-2415K	32"L x 16-1/8"W x 36-3/4"H	330 Lbs	Black	Set	1
UC-3019G	40-3/4"L x 19-1/2"W x 37-3/8"H	400 Lbs	Gray	Set	1
UC-3019K	40-3/4"L x 19-1/2"W x 37-3/8"H	400 Lbs	Black	Set	1
UC-RB	Refuse Bin			Each	3
UC-SB	Silverware Bin			Each	6
UC-WH	Caster			Each	1/30
UC-WHB	Caster w/ Brake			Each	1/30



UC-SB



UC-RB



UC-2415G shown with accessory bins

3-TIER STAINLESS STEEL TROLLEYS

- ◆ Caster bumpers protect walls, doors, and the cart from minor collisions
- ◆ Ships knocked down



SUC-30

ITEM	DESCRIPTION (L X W X H)	UOM	CASE
SUC-30	30" x 16" x 33" (w/Casters)	Set	1
SUC-40	33" x 17" x 35" (w/Casters)	Set	1
SUC-50	37" x 19" x 37" (w/Casters)	Set	1
SUC-CT	Caster for SUC-Series	Each	4/16
SUC-CTB	Caster w/Brake for SUC-Series	Each	4/16



Caster with brake

LUG BOX/BUS BOX CARTS

ALUMINUM END-LOAD 6-TIER BUS BOX CART

- ◆ 14 gauge aluminum with a 1" extruded aluminum tube frame
- ◆ 5" Dia x 1-1/4" W, full swivel casters
- ◆ Ships knocked down
- ◆ Capacity: 6 (or more when stacked) bus or lug boxes

ITEM	DESCRIPTION	UOM	CASE
ABBC-6	18-5/8" x 26" x 70-1/4", Fits PL-5G, PL-5K, PL-5W, PL-7G, PL-7K, PL-7W, PL-8 Winco® Bus Boxes	Set	1
ALRC-5ST	Caster for ABBC-6	Each	12

Move more
at once



ABBC-6

ALUMINUM LUG BOX CART

- ◆ 14 gauge aluminum with a 1" extruded tube frame
- ◆ 5" Dia x 1-1/4" W, full swivel casters
- ◆ Ships knocked down
- ◆ Use with single or stacked lug boxes

ITEM	DESCRIPTION	UOM	CASE
ALBC-1	16-3/4" x 25-1/16" x 19", Fits PL-5, PL-7, PL-8 Winco® Lug Boxes	Set	1
ALRC-5ST	Caster for ALBC-1	Each	12



ALBC-1

DURABLE POLYPROPYLENE DRY INGREDIENT BINS

- ◆ Ideal mobile storage for dry bulk ingredients
- ◆ Space-efficient under-counter height
- ◆ Advanced super-clasp slanted lid design easily slides open to scoop ingredients; when closing, lid slides over the bin to reduce possible debris on the lid from falling in
- ◆ Quickly view contents through the clear cover
- ◆ Four 3" casters (2 fixed & 2 swivel w/brakes) for easy mobility
- ◆ Built-in storage holds the included scoop, effectively keeping the handle out of ingredients

ITEM	DESCRIPTION	SIZE	UOM	CASE
IB-21	21 Gallon	13" x 29-1/4" x 28"	Set	1
IB-27	27 Gallon	15-1/2" x 29-1/2" x 28"	Set	1
IB-C3	Fixed Caster	3" Dia, Fits IB-21 and IB-27	Each	1
IB-C3B	Swivel Caster w/Brake	3" Dia, Fits IB-21 and IB-27	Each	6
IB-21-LE	Lid	Fits IB-21	Each	6
IB-27-LE	Lid	Fits IB-27	Each	6

ITEM	WEIGHT SUGAR	WEIGHT FLOUR
IB-21	159 lbs	124 lbs
IB-27	197 lbs	154 lbs

DRY BULK INGREDIENT BINS



Built-in scoop storage



IB-21



IB-C3B



IB-C3

IB-SERIES

INSULATED ICE CADDY



NSF IIC-SERIES

IIC-29

INSULATED ICE CADDY

- ◆ Can be used inside or outdoors, in hot or humid conditions
- ◆ Drain shelf allows ice melt to flow away from ice cubes, greatly increasing storage time
- ◆ Polyethylene molded body is durable and light-weight, top lid slides open
- ◆ Polyurethane foam insulation effectively keeps ice cold for several days
- ◆ Recessed front handle for convenient pulling or lifting
- ◆ No assembly required
- ◆ 125 lb capacity

ITEM	DESCRIPTION	SIZE	UOM	CASE
 IIC-29	Ice Caddy w/Sliding Lid	Ext Dim: 23" x 31.5" x 29.25"	Set	1
IIC-C8	Caster for IIC-29	8"	Each	1
IIC-C5B	Brake Caster for IIC-29	5"	Each	6

HOT / COLD FOOD TRANSPORTERS



IFT-1



IFT-2
Built-in dolly with casters



IFT-1 & IFT-1D



INTERIOR VIEW IFT-1



IFT-1D (INCLUDES STRAP)
Can also be used with IFPC-series

FULL-SIZE HOT/COLD FOOD TRANSPORTERS

- ◆ Molded polypropylene and insulated with polyurethane foam to maintain safe food serving temperatures for hours without the use of electricity or sterno
- ◆ Adjustable vent cap equalizes outside and inside compartment pressure for easy lid opening
- ◆ Stackable and interlockable for easy storage, and space saving
- ◆ Standard food service pans are easy to load and remove
- ◆ Easy-clean holding compartments

ITEM	DESCRIPTION	UOM	CASE
IFT-1	Single Cabinet Insulated Food Pan Transporter	Set	1
 IFT-2	Double Cabinet Insulated Food Pan Transporter w/Built-In Dolly	Set	1
IFT-1D	Dolly w/Casters & Cargo Strap fits IFT-1	Set	1
IFT-C5	5" Caster for IFT-2 & IFT-1D	Each	1
IFT-C5B	5" Brake Caster for IFT-2 & IFT-1D	Each	1

ITEM	DIMENSIONS	COMPARTMENT CAPACITY	
IFT-1	Exterior Dimensions: 18-3/4"W x 26-3/4"D x 24-1/2"H Interior Dimensions: 13-1/4"W x 21"D x 19-5/16"H	6 Full-Size, 2.5" H 4 Full-Size, 4" H 3 Full-Size, 6" H 4 Half-Size, 6" H	8 Half-Size, 4" H 9 1/3 Size, 6" H 12 1/3 Size, 4" H 6 1/3 Size, 8" H
IFT-2	Exterior Dimensions: 20"W x 27-1/2"D x 47-1/4"H Interior Dimensions for Each Compartment: 13-1/4"W x 21"D x 17"H	Each of the two compartments: 4 Full-Size, 2-1/2" H 3 Full-Size, 4" H 2 Full-Size, 6" H 10 Half-Size, 2-1/2" H	Can hold the following pans: 6 Half-Size, 4" H 4 Half-Size 6" H 6 1/3rd Size, 6" H 9 1/3rd Size, 4" H
IFT-1D		Use with IFT-1	

HOT					
IFT	188°F	184°F	179°F	175.5°F	171.5°F
IFPC	188°F	184.5°F	181.5°F	179°F	176°F
Starting Temperature	1 hour	2 hours	3 hours	4 hours	
COLD					
IFT	33.8°F	34.6°F	35.4°F	36.3°F	37.1°F
IFPC	32°F	33°F	34°F	35.5°F	36.5°F
Starting Temperature	1 hour	2 hours	3 hours	4 hours	

NSF IFT-SERIES



WINGO BAG™ PREMIUM PIZZA BAGS

Constructed from sturdy 3-layer fabric, maintains food temperature for longer without condensation buildup.

- ◆ Breathable liner reduces condensation
- ◆ Insulated flaps help retain temperature
- ◆ Dual closure velcro and buckle to keep contents secure
- ◆ Multiple straps for secure hold and stability
- ◆ Hanging loop for storage/drying
- ◆ Clear pockets positioned for storing slips, menus, or to add custom branding
- ◆ Reflector strip for safety
- ◆ Pizza box capacities: (M) holds (4) 16" / (L) holds (3) 18"

ITEM	DESCRIPTION	UOM	CASE
BGPZ-1909	19"W x 19"D x 9"H (M)	Each	1/6
BGPZ-2109	21-1/2"W x 21-1/2"D x 9"H (L)	Each	1/6



Restaurant



Catering



Delivery



Strap on bottom, top and sides for easy transport

DELIVERY BAGS



Premium Pizza Delivery Bags

"The delivery solution engineered for savings and functionality."



BGPZ-1909 (M)

BGPZ-2109 (L)

PIZZA & MORE DELIVERY BAGS

From kitchen to table, our insulated delivery bags maintain temperature over standard delivery range.

- ◆ Outer shell / liner: polyester, Filling: EPE
- ◆ Insulated liner retains heat for 2 hours @ 167°F / for 4 hours @ 131° / for 6 hours @ 95°F

ITEM	DESCRIPTION	UOM	CASE
BGDV-12	12" x 12" x 12"	Each	6
BGDV-22	22" x 22" x 12"	Each	6
BGPZ-18	18" x 18" x 5" Pizza Bag	Each	6
BGPZ-20	20" x 20" x 5" Pizza Bag	Each	6
BGPZ-24	24" x 24" x 5" Pizza Bag	Each	6



BGPZ-SERIES



BGDV-22



BGDV-12

DELIVERY BAGS



Premium Food Delivery Bags

"The delivery solution engineered for savings and functionality."

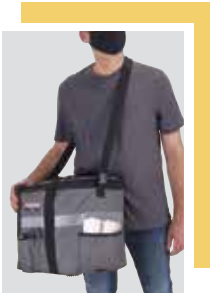

BGCB-1212 worn cross-body



BGCB-1212 (S)



(M) Includes divider



BGCB-1709 (M)



BGCB-1709 using anchor straps



WINGO BAG™ PREMIUM CATERING BAGS

The delivery solution engineered for savings and functionality.

- ◆ High-performance insulation retains temperature
- ◆ Waterproof liner prevents leaking and is easy to clean
- ◆ Integrated reinforced bottom for stability
- ◆ Built-in rubber feet reduce wear and tear over time
- ◆ Moisture-resistant exterior prevents bacteria, mold, odors
- ◆ Clear pockets positioned for storing slips, menus, or to add custom branding
- ◆ Anchor strap to secure bag - ideal for bike and scooter delivery (cord not included)
- ◆ Reflector strip for safety
- ◆ Removable 12 compartment divider to keep beverages, soups and other liquids upright and organized (divider comes with BGCB-1709 only)

ITEM	DESCRIPTION	UOM	CASE
BGCB-1212	12"W x 12"D x 12"H (S)	Each	1/6
BGCB-1709	17"W x 13"D x 9"H (M), Beverage Divider	Each	1/6
BGCB-2314	23"W x 15"D x 14"H (L)	Each	1/4
BGCB-2212	22"W x 22"D x 12"H (XL)	Each	1/4



BGCB-2314 (L)



BGCB-2212 (XL)



WINGO BAG™ PREMIUM BACKPACK

Delivery on the GO with ease and comfort.

- ◆ High-performance insulation retains temperature
- ◆ Adjustable contoured straps and padded back, ideal for bike and scooter delivery
- ◆ Waterproof liner prevents leaking and is easy to clean
- ◆ Integrated reinforcements for lightweight bag stability
- ◆ Dual close zipper and buckle to keep contents secure
- ◆ Clear pocket with zipper closure for storing slips, menus, or to add custom branding
- ◆ Built-in rubber feet reduce wear and tear over time
- ◆ Moisture-resistant exterior prevents bacteria, mold, odors
- ◆ Reflector strip for safety
- ◆ Holds up to (8) medium-size containers



BGDB-1616



ITEM	DESCRIPTION	UOM	CASE
BGDB-1616	16"W x 13"D x 16"H	Each	1/4

Restaurant



Catering



Delivery



EQUIPMENT

Clean, Prep,
Cook, Hold &
Merchandise





- ✓ **SAVES TIME**
- ✓ **SAVES LABOR**
- ✓ **MORE VERSATILITY**
- ✓ **MORE PROFIT**

GLASS WASHERS



A-200



A-200 & A-205-P

- ◆ Five spinning brushes (four 6" brushes and one 6-3/4" center brush) clean inside and out simultaneously for crystal clear glassware



BAR MAID® GLASS WASHERS

- ◆ Quiet, powerful 1/3 HP enclosed motor with sealed lower bearing and exclusive Splashguard canopy
- ◆ Automatic overload safety & ground fault protection plug
- ◆ Heavy bronze bearings and stainless steel construction

ITEM	OVERALL DIMENSIONS L" x D" x H" (mm)	POWER	PLUG	SHIP WEIGHT
A-200	12 x 8 x 18 (305 x 203 x 457)	115V-60Hz, 440W, 4.3A,	NEMA 5-15P, G.F.C.I. included	27 lbs (12.2 kgs)
A-205-P		*220-230V- 50/60Hz,	Type E, G.F.C.I. not included	23 lbs (10.4 kgs)



ITEM	DESCRIPTION	UOM	CASE
A-200	Upright Glass Washer, 115V	Box	1
A-205-P	Upright Glass Washer, 220V, International	Box	1

2 YEAR WARRANTY



SS-100



SS-100



BAR MAID® SUBMERSIBLE GLASS WASHER

- ◆ Compact design fits under bars even if space is tight
- ◆ Heavy-duty stainless steel construction and bronze bearings deliver outstanding performance and reliability
- ◆ Submersible 1/3 HP motor with automatic overload and ground fault protection plug

ITEM	OVERALL DIMENSIONS L" x D" x H" (mm)	POWER	PLUG	SHIP WEIGHT
SS-100	12 x 8 x 12 (305 x 203 x 305)	115V-60Hz, 440W, 4.3A,	NEMA 5-15P, G.F.C.I. included	27 lbs (12.2 kgs)



ITEM	DESCRIPTION	UOM	CASE
SS-100	Submersible Glass Washer, 115V	Box	1

2 YEAR WARRANTY

NOTHING CLEANS GLASSWARE FASTER OR BETTER



- ◆ Five spinning brushes (four 6" brushes and one 6-3/4" center brush) clean inside and out simultaneously for crystal clear glassware

BAR MAID® GLASS PRO™ GLASS WASHER

- ◆ Heavy duty stainless steel construction
- ◆ 1/3 HP motor with automatic overload and ground fault protection plug

ITEM	OVERALL DIMENSIONS L" x D" x H" (mm)	POWER	PLUG	SHIP WEIGHT
AA	12 x 8 x 17-3/4 (305 x 203 x 450)	115V-60Hz, 440W, 4.3A	NEMA 5-15P, G.F.C.I. included	27 lbs (12.2 kgs)

ITEM	DESCRIPTION	UOM	CASE
AA	Upright Glass Washer, 115V	Box	1



GLASS WASHERS



AA



AA-SERIES

BAR MAID® GLASS PRO™ SUBMERSIBLE GLASS WASHER

ITEM	OVERALL DIMENSIONS L" x D" x H" (mm)	POWER	PLUG	SHIP WEIGHT
AA-SUB	12 x 8 x 11 (305 x 203 x 280)	115V-60Hz, 440W, 4.3A	NEMA 6-15P, G.F.C.I. included	27 lbs (12.2 kgs)

ITEM	DESCRIPTION	UOM	CASE
AA-SUB	Submersible Glass Pro Glass Washer, 115V	Box	1



Sparkling Clean



AA-SUB



AA-SERIES





GENTLE, EFFECTIVE CLEANING

GLASS WASHER BRUSHES



BRS-980



BRS-732SG



BRS-920



BRS-922



BRS-975



BRS-976



BRS-950



BRS-930



BRS-935

BAR MAID® GLASS WASHER BRUSHES

ITEM	DESCRIPTION	TYPE	UOM	CASE
BRS-732SG	Shot Glass Brush	Pinned	Each	1/18
BRS-980	4" Scrub Brush, For Muffin Pans	Pinned	Each	1/6
BRS-917	6" Standard Brush	Pinned	Each	1/18
BRS-920	6-3/4", For Slightly Taller Glassware	Pinned	Each	1/18
BRS-922	7-1/2", For Taller Glassware	Pinned	Each	1/18
BRS-975	8-1/2", For Extra Tall Glassware	Pinned	Each	1/18
BRS-975S	8-1/2" Softie® Brush, For Delicate Extra-Tall Glassware	Pinned	Each	1/18
BRS-976	9" Pilsner Brush	Pinned	Each	1/18
BRS-950	Margarita & Martini Glass Brush	Pinned	Each	1/6
BRS-930	Wide Coffee Pot & Pitcher Brush	Pinned	Each	1/6
BRS-935	Narrow Top Coffee Pot Brush	Pinned	Each	1/18

Measurement is the "usable" length of the brush



BAR MAID® GLASS WASHER BRUSH SETS

ITEM	DESCRIPTION	TYPE	UOM	CASE
BRS-1722	Replacement Brush Set Includes (4) 6" Standard Brushes & (1) 7-1/2" For Taller Glassware Brush, Fits all Bar Maid models	Pinned	Box	1/6
BRS-1720SL	Replacement Universal Brush Set Includes (4) 6" Standard Brushes & (1) 6-3/4" Brush for Slightly Taller Glassware	Slotted	Box	1/6



BRS-1722

☑ **DISINFECT**

☑ **SANITIZE**

☑ **DEODERIZE**



BAR MAID® SANI-MAID DISINFECTANT, SANITIZER AND DEODORANT TABLETS

A multi-use germicidal disinfectant, sanitizer and true deodorant.

- ◆ Dissolve instantly in warm or cold water
- ◆ Use one tablet per gallon for 200 ppm or two tablets per gallon for 400 ppm
- ◆ Does not harm any surface not harmed by water.
- ◆ Controls odors
- ◆ No chlorine taste or odor
- ◆ 200 tablets per bottle

ITEM	DESCRIPTION	UOM	CASE
DIS-207	Quaternary Sanitizer/Disinfectant Tablets, 4 Bottles	Box	1/12

GLASS CLEANERS



DIS-207



DET-1200



BAR MAID® LOSUDS LIQUID CONCENTRATE

Liquid glassware detergent for electric and manual glass washers effectively removes stains, residue, and contaminants without leaving streaks or spots. Excellent in all types of water and easy on hands.

- ◆ Cuts grease and oils, leaving glassware spotless
- ◆ Save money – 1/4 ounce to 3 gallons of water is all you need for sparkling clean glassware
- ◆ 128 applications per 1 quart bottle

ITEM	DESCRIPTION	UOM	CASE
DET-1200	LoSUDS Concentrate, (12) 1 Qt Bottles Per Case	Each	12

BAR MAID® SANITIZER STRIPS

Ensure your dishes and glassware are properly sanitized.

- ◆ Convenient dispenser saves unused strips from damage
- ◆ Approximately 100 strips per dispenser
- ◆ 12 dispensers per display box

ITEM	DESCRIPTION	UOM	CASE
DIS-202	Quaternary Strips in Roll	Box	1/100
DIS-302	Chlorine Strips in Roll	Box	1/50
DIS-303	Chlorine Strips in Vial	Each	1/500



DIS-302



DIS-202



DIS-303

BAR MAID® PH TEST STRIPS

Monitor water quality in food service applications. Simply dip pH test strip in a solution and compare to color chart on package.

- ◆ Convenient dispenser saves unused strips from damage
- ◆ 3 – 5.5 range for food service applications
- ◆ Approximately 100 per dispenser

ITEM	DESCRIPTION	UOM	CASE
DIS-402	pH Test Strips in Dispenser	Each	1/12



DIS-402





ONE EMPLOYEE CAN POLISH HUNDREDS OF GLASSES PER HOUR

GLASS POLISHERS



UP TO
350
PIECES PER HOUR



GP-100

2 YEAR WARRANTY

On-demand glassware polishing solution that saves on labor, replacement costs, and injury claims.

- ◆ Efficient: warm air flow dries just-washed glassware while polishing
- ◆ Sanitary: reduces unhygienic handling & lint-free
- ◆ Safe: low risk of breakage, reducing injury claims and glassware replacement costs
- ◆ Portable: lightweight and compact footprint with built-in handles for polishing options anywhere
- ◆ Polishing heads are soft and absorbent, removable, and washable



BAR MAID® GLASS POLISHER

- ◆ High-volume on-demand polishing
- ◆ 5 standard size polishing heads
- ◆ Ideal for caterers, restaurants, event halls, and more

ITEM	OVERALL DIMENSIONS L" x D" x H" (mm)	POWER	PLUG	SHIP WEIGHT
GP-100	12.8 x 11.8 x 19.7 (325 x 300 x 500)	120V-50/60Hz, 1350W, 12.5 A	NEMA 5-15P	38 lbs (17.3 kgs)



ITEM	DESCRIPTION	UOM	CASE
GP-100	Glass Polisher with 5 Polishing Heads	Each	1



On-demand solutions



UP TO
290
PIECES PER HOUR



GP-3MINI



BAR MAID® COMPACT GLASS POLISHERS

- ◆ 3 standard size polishing heads
- ◆ Ideal for hotels, bars, tasting rooms, casinos, and more

ITEM	OVERALL DIMENSIONS L" x D" x H" (mm)	POWER	PLUG	SHIP WEIGHT
GP-3MINI	10.63 x 9.25 x 20.9 (270 x 235 x 530)	110V-50/60 Hz, 1300W, 12.5 A	NEMA 5-15P	33 lbs (14.8 kgs)
GP-3MINI-CE		220V-50/60 Hz	CEE 7/7	



ITEM	DESCRIPTION	UOM	CASE
GP-3MINI	Glass Polisher with 3 Polishing Heads, 110V	Each	1
GP-3MINI-CE	Glass Polisher with 3 Polishing Heads, 220-240V	Each	1

- ✓ **HIGH-VOLUME**
- ✓ **LOW-RISK**
- ✓ **CONSISTENTLY CLEAR RESULTS**



BAR MAID® GLASS POLISHER BRUSHES

- ◆ Soft, absorbent, and washable

ITEM	DESCRIPTION	TYPE	UOM	CASE
GP-554	5" Polishing Head for Champagne Flutes	Slotted	Each	1/10
PH-5C	6" Polishing Head for Center Slot	Slotted	Each	1/3
PH-1	7" Standard Polishing Head	Slotted	Each	1
PH-3S	3-Pc Set Polishing Heads for GP-3MINI	Slotted	Set	1/5
PH-5S	5-Pc Set Polishing Heads for GP-100	Slotted	Set	1/3
GP-552-LB	5-Pc Set: (1) 7" Standard & (4) 8" Carafe, Long Polishing Heads for GP-100	Slotted	Set	1/3
GP-533-LB	Long Blower Tube, Use With GP-552-LB, for GP-100	Slotted	Each	1

Measurement is the "usable" length of the brush



GLASS POLISHER BRUSHES



GP-554



PH-3S



PH-1



PH-5S



PH-5C

BAR MAID® GLASS POLISHING WAND

- ◆ Flexible wand tip contours to shape of glass for reduced stress and gentle polishing
- ◆ Included cloth sleeve is lint-free and washable

ITEM	DESCRIPTION	UOM	CASE
GP-1M	Manual Polishing Wand	Each	1/35
GP-3MC	Polishing Wand Replacement Pack Cloths, 3 per Pack	Pack	1/6

Lint-free shine ✨



GP-1M



GP-3MC





A WIN FOR THE HOUSE AND THE PLAYERS

GAME CHIP CLEANERS

NEW

60+
PIECES PER MINUTE



CP-3000-D-CC

NEW

140+
PIECES PER MINUTE



CP-7000-CC

NEW

160+
PIECES PER MINUTE



CP-7000-S-CC

BAR MAID® CHIP CHAMPION™

Process thousands of game chips, dice, and tiles through the Chip Champion™ every hour for clean, germ-free dealing and playing.

- ◆ Step 1 - Sanitize with quaternary tablet sanitizer solution (sold separately)
- ◆ Step 2 - Process through the Chip Champion to scrub and dry
- ◆ Fast ROI: gain significant speed, efficiency, and cost savings, ensuring an enjoyable gaming experience
- ◆ Sanitary: reduces unhygienic handling, and UV-C light kills contaminants for safe service
- ◆ Portable: compact footprint fits most work tables for portable polishing options

ITEM	DESCRIPTION	UOM	CASE
CP-3000-D-CC	Game Chip Polisher 120V, 3,000-4,000 pcs/hour	Each	1
CP-7000-CC	Game Chip Polisher 120V, 7,000-9,000 pcs/hour	Each	1
CP-7000-S-CC	Game Chip Polisher 120V, 10,000 pcs/hour, With Feeder	Each	1
CP-REFILL	Granulate Refill, 12-1/2 lb Bag	Each	1



Clean and ready for game-play

ETL Intertek CP-SERIES

New Item



- ✓ **GAIN SPEED & COST SAVINGS**
- ✓ **MORE SANITARY**
- ✓ **MAINTAIN CUSTOMER CONFIDENCE**



BAR MAID® FLATWARE POLISHERS

Effectively remove spots, streaks, and bacteria from flatware for a sparkling clean and eliminate doubts about the cleanliness of your establishment.

- ◆ Efficient: polish flatware directly from the dishwasher for optimal clean & dry shine
- ◆ Fast ROI: gain significant speed, efficiency, and cost savings over hand-polishing
- ◆ Sanitary: reduces unhygienic handling, and UV-C light kills contaminants for safe service
- ◆ Portable: compact footprint fits most work tables for portable polishing options
- ◆ Spotless Reputation: maintain customer confidence in a clean establishment with spot-free, streak-free, bacteria-free flatware

ITEM	DESCRIPTION	UOM	CASE
CP-3000-D	Flatware Polisher 120V, 3,000-pcs/hour, 22-1/2"L x 20-1/2"W x 17"H	Each	1
CP-7000	Flatware Polisher 120V, 7,000-pcs/hour, 25-1/2"L x 24-1/2"W x 19"H	Each	1
CP-REFILL	Flatware Polisher Granulate Refill, 12-1/2 lb Bag	Each	1



FLATWARE POLISHERS



CP-3000-D



CP-7000



CP-SERIES



Granulate

CP-REFILL

COMMERCIAL MANUAL CAN OPENERS



Portable clamp included



Removable blade



Securely clamps to work surface



Easy operation

PREMIUM MANUAL CAN OPENERS

Our premium European-made heavy-duty stainless steel can opener is fitted with a removable clamp, ideal for on-the-go operations that require flexibility. The rust-resistant stainless steel gear and blade effectively opens various can sizes up to #10.

- ◆ Includes base, blade, gear and installation kit for mounting on wooden or stainless steel work tables
- ◆ Easily disassembles for cleaning/sanitizing
- ◆ Heavy-duty stainless steel construction
- ◆ Rigid universal mounting base for screw-down or clamp-on installation with wooden or stainless steel work tables
- ◆ 19" (482mm) long bar accommodates various sizes of cans up to 16" (406mm) tall
- ◆ Quick change dual-sided tempered knife blade and stainless steel gear

ITEM	OVERALL DIMENSIONS L" X D" X H" (mm)	SHIP WEIGHT
CO-3N	8-7/16 x 4 x 25-1/2 (214 x 102 x 648)	5.6 lbs (2.5 kg)

ITEM	DESCRIPTION	UOM	CASE
CO-3N	Stainless Steel Base, NSF	Each	1/12
CO-3N-B	1-Pc S/S Replacement Blade for CO-3N	Each	1
CO-3G	1-Pc S/S Replacement Gear Set for CO-3N	Each	1



CO-3N-B



CO-3G



CO-3N portable clamp



CO-3N

STANDARD #1 MANUAL CAN OPENER

The go-to industry standard, steel body can opener, made for heavy usage kitchen environments that require processing of up to 50 cans a day. Opens various can sizes up to #10.

- ◆ Includes base, blade, gear and installation kit
- ◆ Rigid universal mounting base for screw-down to a wooden or stainless steel work table
- ◆ 13" (330mm) long bar accommodates any size can up to 10" (254mm) tall
- ◆ Extra-durable dual-sided knife blade and gear are interchangeable with most other can opener brands



CO-1



Securely clamps to work surface

ITEM	DESCRIPTION	UOM	CASE
CO-1	Cast Iron Body	Set	1
CO-1B	2-Pc Replacement Blade Set for CO-1	Set	24/288
CO-1G	1-Pc Replacement Gear Set for CO-1	Each	12/144



CO-1B



CO-1G

HEAVY-DUTY CAST IRON MEAT GRINDER

The Winco manual meat grinder is an economical and reliable tool for all your meat processing needs. With interchangeable plates, make your own sausages, burgers and more.

- ◆ Large 3" by 4" (76 x 102 mm) hopper opening
- ◆ Heavy-duty cast iron construction with food-safe tinned coating
- ◆ Durable cast iron grinding knife
- ◆ Easy to crank handle with heavy-duty nylon bearing for long life
- ◆ Two (2) grinding plates: medium grind 3/16" (4mm), coarse grind 5/16" (8mm)
- ◆ Sausage stuffing kit with three (3) stuffing tubes: 9/16" (14 mm), 3/4" (19 mm), & 15/16" (24 mm), stuffing star, and flange
- ◆ Clamp base easily secures to countertop or work surface

ITEM	OVERALL DIMENSIONS L" X D" X H" (mm)	SHIP WEIGHT
MG-10	10 x 4-1/4 x 8-7/8 (254 x 108 x 226)	5.5 lbs (2.5 kg)



ITEM	DESCRIPTION	UOM	CASE
MG-10	Meat Grinder with Clamp Base	Set	1/10
MG-1018	Grinder Plate, 1/8" (3mm)	Each	100
MG-10316	Grinder Plate, 3/16" (4mm)	Each	100
MG-1014	Grinder Plate, 1/4" (6mm)	Each	100
MG-10516	Grinder Plate, 5/16" (8mm)	Each	100
MG-1038	Grinder Plate, 3/8" (10mm)	Each	100
MG-10K	Grinder Knife	Each	100
MG-10SSK	Sausage Stuffing Kit 1 Flange & 3 Tubes	Each	100

KATTEX™ MEAT GRINDER



MG-10



HEAVY-DUTY BURGER PATTY PRESS WITH INTERCHANGEABLE PLATES

Effortlessly make uniform burgers with this time-saving portion control molding press. Interchangeable plates make either 4" (1/4 lb) or 5" (1/2 lb) round patties.

- ◆ Heavy-duty anodized aluminum construction with stainless steel press bowls and press plates
- ◆ Manual single-lever operation for quick, easy press-and-release uniform patties
- ◆ Interchangeable 4" (100mm) and 5" (130mm) press plates & bowls; removal tool included
- ◆ Built-in patty paper holder, and includes 500 each of both 4" and 5" diameter patty paper

ITEM	OVERALL DIMENSIONS L" X D" X H" (mm)	SHIP WEIGHT
HBP-3	10 x 9-1/2 x 12-3/4 (254 x 241 x 324)	18.1 lbs (8.2 kg)



ITEM	DESCRIPTION	UOM	CASE
HBP-3	Hamburger Patty Press	Set	1
HBP-PR100	4" (100mm) Perforated Round Patty Paper, Case of 5000	Case	1/10
HBP-PR130	5" (130mm) Perforated Round Patty Paper, Case of 5000	Case	1/10



KATTEX™ BURGER PATTY PRESS



HBP-3



KATTEX™ FRUIT & VEGETABLE SLICER



FVS-1

QUICK-SLICE FRUIT & VEGETABLE SLICER

Save on time and labor - simply place produce in the holder to turn out uniform slices in seconds.

- ◆ Aluminum construction with 9-1/4" stainless steel adjustable blade
- ◆ Adjustable thickness gauge - select from 1/16" (1mm) up to 1/2" (12mm) thick slicing
- ◆ Accommodates fruits/vegetables up to 4" diameter and 5-1/2" in length
- ◆ Mounting bracket included - mounts directly to work surface, or on the cutting board mount (CBM-1218)

ITEM	OVERALL DIMENSIONS L" X D" X H" (mm)	SHIP WEIGHT
FVS-1	16 x 8-11/16 x 16 (406 x 220 x 406)	12.1 lbs (5.5 kgs)

ITEM	DESCRIPTION	UOM	CASE
FVS-1	21"L x 10-3/4"W x 16"H	Each	1/2
FVS-1B	2-Pc Replacement Blades	Set	1/10
FVS-1SB	Replacement Shaft and Blade Turntable Assembly	Each	1/6

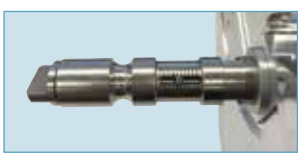

Thickness gauge



Replacement blade



FVS-1 mounted and ready

CUTTING BOARD MOUNT FOR FRUIT & VEGETABLE SLICER

Add portability to Kattex FVS-1 Slicer with this customized STATIKBOARD™ cutting board mount. The molded-through, non-slip feet prevent slipping & sliding, even on wet countertops, and the fully-rubberized hook provides easy storage.

- ◆ Board size: 12" (30.5mm) x 18" (45.7mm) x 1/2" (1.3mm)
- ◆ Built-in hook for easy transport and hygienic storage
- ◆ Dishwasher safe tough durable copolymer board construction
- ◆ Stainless steel flush mounting hardware included (mounting bracket sold separately or comes with FVS-1)

ITEM	DESCRIPTION	UOM	CASE
CBM-1218	Cutting Board Mount for FVS-1	Each	1



STATIKboard™
Patented original design

NSF CBM-1218

New Item

PRECISE-SLICE TOMATO SLICERS

Razor sharp stainless steel blades cradle delicate tomatoes, while smoothly and swiftly producing clean, uniform slices.

- ◆ Cast aluminum frame with stainless steel blades for even, clean cuts; blades are replaceable
- ◆ Ergonomic vertical handle provides smooth, effortless slicing
- ◆ Cuts 2 dozen tomatoes into 3/16" or 1/4" thick slices in only 1 minute!
- ◆ HDPE slicing surface for safe & durable food processing
- ◆ Rubber non-slip feet ensure maximum stability
- ◆ Slicers come standard with a stop/hold bracket

ITEM	OVERALL DIMENSIONS L" X D" X H" (mm)	SHIP WEIGHT
TTS-188	16-1/2 x 8-1/4 x 9-1/2 (420 x 210 x 240)	9.3 lbs (4.2 kgs)
TTS-188S		
TTS-250		
TTS-250S		

ITEM	DESCRIPTION	UOM	CASE
TTS-188	3/16" Cut w/Straight Blade	Set	1/4
TTS-188S	3/16" Cut w/Serrated Blade	Set	1/4
TTS-250	1/4" Cut w/Straight Blade	Set	1/4
TTS-250S	1/4" Cut w/Serrated Blade	Set	1/4

TOMATO SLICER ACCESSORIES

ITEM	DESCRIPTION	UOM	CASE
TTS-188-B	3/16" Straight Blade Assembly for TTS-188	Set	1/12
TTS-188S-B	3/16" Serrated Blade Assembly for TTS-188	Set	1/12
TTS-250-B	1/4" Straight Blade Assembly for TTS-250	Set	1/12
TTS-250S-B	1/4" Serrated Blade Assembly for TTS-250	Set	1/12
KAT-FT	4-Pc Replacement Feet Set	Set	1
KAT-WR	Dual-End Wrench	Each	1/25

KATTEX™ TOMATO SLICERS

Includes blade replacement wrench



TTS-188



TTS-188-B

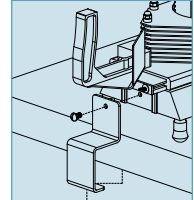

Stop/hold bracket included

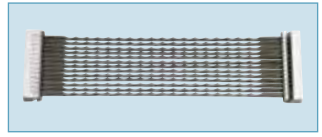

TTS-188S-B



KAT-WR

TTS-SERIES NSF

QUICK-SLICE CHEESE SLICERS

Make light work of slicing a variety of semi-soft cheeses, with uniform, consistent results. Ideal for portion control and faster food prep.

- ◆ Cast aluminum construction with stainless steel wires
- ◆ Cutting area accommodates 1/3 of a 5 lb cheese block
- ◆ Cut 3/8" or 3/4" cheese sticks, cubes or slices
- ◆ Cleaning brush included

ITEM	OVERALL DIMENSIONS L" X D" X H" (mm)	SHIP WEIGHT
TCT-375	13 1/4 x 6 1/4 x 4 1/2 (335 x 170 x 115)	4.2 lbs (1.9 kgs)
TCT-750		

ITEM	DESCRIPTION	UOM	CASE
TCT-375	3/8" Cut	Each	1/4
TCT-750	3/4" Cut	Each	1/4

CHEESE SLICER ACCESSORIES

ITEM	DESCRIPTION	UOM	CASE
TCT-375B	Replacement Bow for TCT-375	Set	1/10
TCT-750B	Replacement Bow for TCT-750	Set	1/10



TCT-375B
3/8" wide cuts



TCT-750B
3/4" wide cuts



Uniformly slice cheese blocks

KATTEX™ CHEESE SLICERS



TCT-375

TCT-750

TCT-SERIES NSF

KATTEX™ ONION SLICERS



OS-250

Includes leg-mounting wrench



KAT-WR



OS-250B
Blade set assembly

NSF OS-SERIES

QUICK-SLICE ONION/FRUIT/VEGETABLE SLICERS

Quickly produce evenly sliced coins of fruits and vegetables in a single smooth stroke.

- ◆ Aluminum construction with stainless steel blades
- ◆ Unique lever-handle allows for quick and easy operation
- ◆ Sturdy base with non-skid feet
- ◆ Two blades included can be stacked to create a finer cut
- ◆ 4-1/2" x 3-3/4" cutting area

ITEM	OVERALL DIMENSIONS L" X D" X H" (mm)	SHIP WEIGHT
OS-188	19 x 10 x 19 (483x 254 x 483)	17.8 lbs (8.1 kgs)
OS-250		

ITEM	DESCRIPTION	UOM	CASE
OS-188	3/16" Cut	Each	1/2
OS-250	1/4" Cut	Each	1/2

ONION/FRUIT/VEGETABLE SLICER ACCESSORIES

ITEM	DESCRIPTION	UOM	CASE
OS-188B	3/16" Blade Set Assembly for OS-series, 2-Pcs/Set	Set	1/10
OS-250B	1/4" Blade Set Assembly for OS-series, 2-Pcs/Set	Set	1/10
KAT-FT	4-Pc Replacement Feet Set	Set	1
KAT-BS-OT	4-Pc Replacement Bushings	Set	1
KAT-WR	Dual-End Wrench	Each	1/25

KATTEX™ LETTUCE CUTTER



TLC-1

Includes leg-mounting wrench

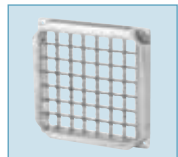

TLC-1-B



KAT-WR

NSF TLC-SERIES

QUICK-SLICE LETTUCE CUTTER

Cut multiple heads of crisp, fresh lettuce in seconds. The interlocking scalloped, pretensioned blades are sized to cut 1 inch squares of cored lettuce, without bruising or browning.

- ◆ Aluminum frame with easy-grip handle
- ◆ Stainless steel blade with 49 square cuts
- ◆ Cuts lettuce into 1" x 1" slices in less than 1 minute
- ◆ Rubber feet prevent slipping/scratching on work surface
- ◆ 7" x 7" cutting area

ITEM	OVERALL DIMENSIONS L" X D" X H" (mm)	SHIP WEIGHT
TLC-1	13 x 18 x 20 (330 x 457 x 508)	17.8lbs (8.1 kgs)

ITEM	DESCRIPTION	UOM	CASE
TLC-1	1" x 1" Cut	Each	1/2

LETTUCE CUTTER ACCESSORIES

ITEM	DESCRIPTION	UOM	CASE
TLC-1-B	Replacement Blade for TLC-1	Each	1/10
KAT-FT	4-Pc Replacement Feet Set	Set	1
KAT-BS-OT	4-Pc Replacement Bushings	Set	1
KAT-WR	Dual-End Wrench	Each	1/25

QUICK-SLICE CHOPPERS/DICERS

For perfectly diced onions and tomatoes, and cucumbers too, turn to the Kattex Chopper/Dicer.

- ◆ Cast aluminum construction with stainless steel blades
- ◆ Sturdy base with non-skid feet
- ◆ 3-3/8" x 3-3/8" cutting area

ITEM	OVERALL DIMENSIONS L" X D" X H" (mm)	SHIP WEIGHT
HCD-250	7-15/16 x 7-15/16 x 18-1/2 (200 x 200 x 470)	7.1 lbs (3.2 kgs)
HCD-375		
HCD-500		

ITEM	DESCRIPTION	UOM	CASE
HCD-250	1/4" Cut	Each	1/4
HCD-375	3/8" Cut	Each	1/4
HCD-500	1/2" Cut	Each	1/4

CHOPPER/DICER ACCESSORIES

ITEM	DESCRIPTION	UOM	CASE
HCD-250BK	1/4" Replacement Blade & Block for HCD-series	Set	1/10
HCD-375BK	3/8" Replacement Blade & Block for HCD-series	Set	1/10
HCD-500BK	1/2" Replacement Blade & Block for HCD-series	Set	1/10
HCD-BR	2-Pc Black Rubber Ring	Set	1/50
KAT-FT	4-Pc Replacement Feet Set	Set	1
KAT-BS-FH	4-Pc Replacement Bushings	Set	1

KATTEX™ CHOPPERS/DICERS



HCD-250

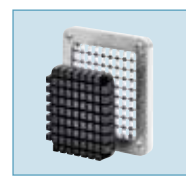

Replacement blade and block

HCD-SERIES

QUICK-SLICE FRUIT WEDGE SLICERS

Get quick and uniform wedges of fruit with a push of the handle. Ideal for coring and sectioning apples, lemons, limes, oranges, and tomatoes.

- ◆ Aluminum construction with sharp stainless steel blades that minimize squeezing and bruising
- ◆ Sturdy base with non-skid feet
- ◆ 3-1/2" diameter cutting area

ITEM	OVERALL DIMENSIONS L" X D" X H" (mm)	SHIP WEIGHT
FWS-6	7-15/16 x 7-15/16 x 18-1/2 (200 x 200 x 470)	5.7 lbs (2.6 kgs)
FWS-8		

ITEM	DESCRIPTION	UOM	CASE
FWS-6	6-Wedge	Each	1/4
FWS-8	8-Wedge	Each	1/4

KATTEX™ FRUIT WEDGE SLICERS



FWS-8



FWS-6BC
Apple corer blade



FWS-6BK
Replacement wedger and blade for citrus fruits

FWS-SERIES

FRUIT WEDGE SLICER ACCESSORIES

ITEM	DESCRIPTION	UOM	CASE
FWS-6BK	6-Section Wedger & Blade Replacement	Set	1/10
FWS-8BK	8-Section Wedger & Blade Replacement	Set	1/10
FWS-6BC	6-Slice Apple Corer Blade	Each	10
FWS-8BC	8-Slice Apple Corer Blade	Each	10
KAT-FT	4-Pc Replacement Feet Set	Set	1
KAT-BS-FH	4-Pc Replacement Bushings	Set	1

KATTEX™

FRENCH FRY CUTTERS - HEAVY-DUTY



HFC-375



Wall mounted with HFC-BK

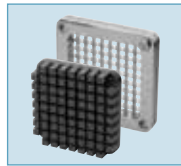

Replacement block and cut blade assembly

NSF HFC-SERIES



QUICK-SLICE FRENCH FRY CUTTERS - HEAVY-DUTY

Add speed and efficiency to slicing potatoes, and fruits & vegetables. The durable cast iron body construction with stainless steel components ensures the cutter will withstand years of high-volume, heavy-duty use.

- ◆ Press down on the short throw handle with comfortable grip for uniform cuts in one smooth stroke
- ◆ Extremely durable cast iron body with stainless steel components
- ◆ Affix to counter or wall mount; wall bracket sold separately
- ◆ 3-3/8" x 3-3/8" cutting area
- ◆ Accessories to modify cut sizes and styles sold separately

ITEM	OVERALL DIMENSIONS L" X D" X H" (mm)	SHIP WEIGHT
HFC-250	8 x 14 x 16 ^{3/4} (203 x 356 x 426)	12.7 lbs (5.8 kgs)
HFC-375		13.6 lbs (6.2 kgs)
HFC-500		13.3 lbs (6 kgs)

ITEM	DESCRIPTION	UOM	CASE
HFC-250	1/4" Cut	Set	1
HFC-375	3/8" Cut	Set	1
HFC-500	1/2" Cut	Set	1

FRENCH FRY CUTTER ACCESSORIES

ITEM	DESCRIPTION	UOM	CASE
HFC-250R	1/4" Cut Replacement Blade	Set	1/48
HFC-375R	3/8" Cut Replacement Blade	Set	1/48
HFC-500R	1/2" Cut Replacement Blade	Set	1/48
HFC-250B	1/4" Cut Blade Assembly	Set	1/24
HFC-375B	3/8" Cut Blade Assembly	Set	1/24
HFC-500B	1/2" Cut Blade Assembly	Set	1/24
HFC-250K	Pusher Block for 1/4" and 1/2" Cut Blade	Each	1/24
HFC-375K	Pusher Block for 3/8" Cut Blade	Each	1/24
HFC-BK	Wall Bracket for HFC series	Each	1/12

FRENCH FRY CUTTERS - MEDIUM-DUTY



FFC-375



FFC-250B

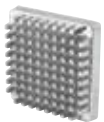

FFC-250K

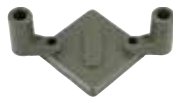

FFC-500P



FFC-6B



FFC-6K



FRENCH FRY CUTTERS - MEDIUM-DUTY

- ◆ Made of heavy-duty cast iron and fitted with sharp stainless steel blades for even slicing
- ◆ Ergonomic handle for easy operation, and sturdy legs for stability on countertop/work surfaces

ITEM	OVERALL DIMENSIONS L" X D" X H" (mm)	SHIP WEIGHT
FFC-250	8 x 14 x 16 ^{3/4} (203 x 356 x 426)	11.6 lbs (5.3 kg)
FFC-375		
FFC-500		

ITEM	DESCRIPTION	UOM	CASE
FFC-250	1/4" Cut	Each	1
FFC-375	3/8" Cut	Each	1
FFC-500	1/2" Cut	Each	1

MEDIUM-DUTY FRENCH FRY CUTTER ACCESSORIES

ITEM	DESCRIPTION	UOM	CASE
FFC-250B	Blade Assembly for FFC-250	Each	24
FFC-250K	Pusher Block for FFC-250	Each	24
FFC-375B	Blade Assembly for FFC-375	Each	24
FFC-375K	Pusher Block for FFC-375	Each	24
FFC-500B	Blade Assembly for FFC-500	Each	24
FFC-500K	Pusher Block for FFC-500	Each	24
FFC-6B	6 Wedge Cut Blade Assembly	Each	1/24
FFC-6K	Pusher Block for FFC-6B	Each	1/24
FFC-8B	8 Wedge Cut Blade Assembly	Each	1/24
FFC-8K	Pusher Block for FFC-8B	Each	1/24
FFC-500P	Pusher Support for FFC-Series	Each	12
HFC-BK	Wall Bracket	Each	1/12

winco[®] BENCH MARK **USA**[™]

Concession Equipment and Supplies

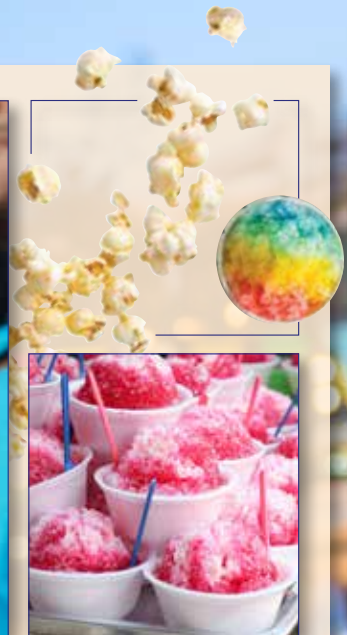

The product & package images shown are for illustration purposes and may differ from actual. Products and specifications subject to change without notice.



POPCORN MACHINES



11040, 11060, & 11080



30010



STREET VENDOR™ POPCORN MACHINES

Take a walk down memory lane with "Street Vendor". Styled after old-time boardwalks of Coney Island and Palisades Park, they remind of an era when vendors sold popcorn on street corners all across America.

- ◆ Easy to use, simple two-switch operation
- ◆ Built-in heated warming deck and warmer light (bulb not included)
- ◆ Old maid drawer catches unpopped kernels
- ◆ Stainless steel food-zone
- ◆ Thick 20 mil non-stick coated popping kettle
- ◆ Tempered glass panels on front and side
- ◆ Clear plexiglass doors at rear

ITEM	OVERALL DIMENSIONS L" X D" X H" (mm)	POWER	PLUG	SHIP WEIGHT
11040	21 x 18 x 34 (534 x 457 x 864)	120V~60Hz, 1040W, 8.6A	NEMA 5-15P	62 lbs (28.1 kgs)
11060		120V~60Hz, 1240W, 10.3A		64 lbs (29 kgs)
11080		120V~60Hz, 1490W, 12.4A		66 lbs (30 kgs)

ITEM	DESCRIPTION	UOM	CASE
11040	4 oz Kettle	Set	1
11060	6 oz Kettle	Set	1
11080	8 oz Kettle	Set	1



Catch tray



Simple two-switch operation



Old maid drawer catches unpopped kernels

STREET VENDOR™ CART

- ◆ Spoked wheels and sturdy handle for easy transport
- ◆ Merchandising side shelf
- ◆ Operator-side storage & work space

ITEM	DESCRIPTION	UOM	CASE
30010	Cart/Trolley for Street Vendor Popcorn Machines 38" w x 23" d x 33" h	Set	1



Convenient storage compartment on service side

The product & package images shown are for illustration purposes and may differ from actual.

METROPOLITAN™ POPCORN MACHINES

The design of "Metropolitan", inspired by the Art Deco style of the 1930's, brings a unique, attractive appeal.

- ◆ Easy to use, simple two-switch operation
- ◆ Built-in heated warming deck and warmer light (bulb not included)
- ◆ Old maid drawer catches unpopped kernels
- ◆ Stainless steel food-zone
- ◆ Thick 20 mil non-stick coated popping kettle
- ◆ Tempered glass panels on front and side
- ◆ Clear plexiglass doors at rear

ITEM	OVERALL DIMENSIONS L" X D" X H" (mm)	POWER	PLUG	SHIP WEIGHT
11045	18-½ x 14 x 30	120V-60Hz, 1040W, 8.6A	NEMA 5-15P	51 lbs (23.1 kgs)
11065	(470 x 356 x 762)	120V-60Hz, 1240W, 10.3A		52 lbs (23.6 kgs)

ITEM	DESCRIPTION	UOM	CASE
11045	4 oz Kettle	Set	1
11065	6 oz Kettle	Set	1

BENCHMARK USA™
POPCORN MACHINES

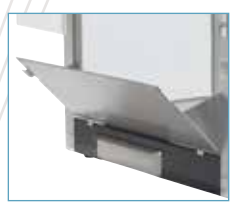

Catch tray



Simple two-switch operation



Old maid drawer catches unpopped kernels

METROPOLITAN™ PEDESTAL BASE

- ◆ 3" swivel casters for easy mobility
- ◆ Storage compartment with interior shelf & door

ITEM	DESCRIPTION	UOM	CASE
30050	Pedestal Base for Metropolitan Popcorn Machines 18-5/8"L x 14-1/4"D x 32-7/8"H	Set	1

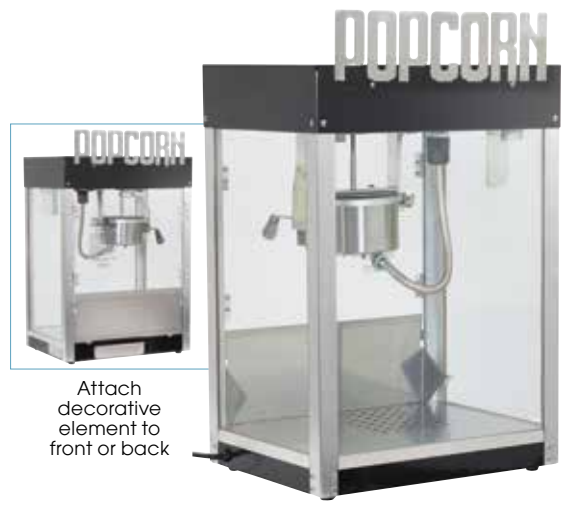

Attach decorative element to front or back

CE ETL US ETL
Intertek Intertek
11045 & 11065



Textured storage door handle

Convenient storage compartment on service side



30050

The product & package images shown are for illustration purposes and may differ from actual.



POPCORN MACHINES



11048 & 11068



30080



PREMIERE™ POPCORN MACHINES

"Premiere" flavorful popped corn in big-screen style.

- ◆ Easy to use, simple two-switch operation
- ◆ Warmer light (bulb not included)
- ◆ Old-maid drawer catches unpopped kernels
- ◆ Stainless steel food-zone for easy cleaning
- ◆ Thick 20 mil non-stick coated popping kettle
- ◆ Tempered glass panels on front and side
- ◆ Clear plexiglass doors at rear

ITEM	OVERALL DIMENSIONS L" X D" X H" (mm)	POWER	PLUG	SHIP WEIGHT
11048	18-1/2 x 14 x 26-1/2 (470 x 356 x 673)	120V-60Hz, 940W, 7.8A	NEMA 5-15P	49 lbs (22.3 kgs)
11068		120V-60Hz, 1140W, 9.5A		50 lbs (22.7 kgs)

ITEM	DESCRIPTION	UOM	CASE
11048	4 oz Kettle	Set	1
11068	6 oz Kettle	Set	1

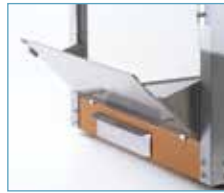

Catch tray



Simple two-switch operation



Old maid drawer catches unpopped kernels

PREMIERE™ PEDESTAL BASE

- ◆ 3" swivel casters for easy mobility
- ◆ Storage compartment with interior shelf

ITEM	DESCRIPTION	UOM	CASE
30080	Pedestal Base for Premiere Popcorn Machines 18-5/8"L x 14-1/4"D x 32-7/8"H	Set	1



Convenient storage compartment on service side

The product & package images shown are for illustration purposes and may differ from actual.

SILVER SCREEN™ POPCORN MACHINES

"Silver Screen" is simple in looking and is technically savvy. A separate cabinet thermostat and temperature indicator accurately controls the heat, ensuring that your popcorn is always at the perfect serving temperature.

- ◆ Stainless steel cabinet and food-zone
- ◆ Thermostatically controlled serving temperature
- ◆ Four-switch configuration allows for any operating situation
- ◆ Built-in warmer light (bulb not included)
- ◆ Old maid drawer catches unpopped kernels
- ◆ Superior performance hard-coat anodized, high thermal popping kettle

ITEM	OVERALL DIMENSIONS L" X D" X H" (mm)	POWER	PLUG	SHIP WEIGHT
11087	20 x 17 x 30 (508 x 432 x 762)	120V-60Hz, 1490W, 12.4A	NEMA 5-15P	60 lb (27.2 kgs)
11147	24 x 19 x 36 (610 x 483 x 915)	120V-60Hz, 1740W, 14.5A	NEMA 5-15P NEMA 5-20P (Canada)	95 lb (43.1 kgs)

ITEM	DESCRIPTION	UOM	CASE
11087	8 oz Kettle	Set	1
11147	14 oz Kettle	Set	1

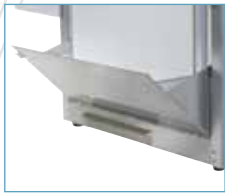

Catch tray



Four-switch operation



Old maid drawer catches unpopped kernels

SILVER SCREEN™ PEDESTAL BASE

- ◆ 3" locking swivel casters for easy mobility
- ◆ Storage compartment with interior shelf

ITEM	DESCRIPTION	UOM	CASE
30087	8 oz Pedestal Base 20"W x 17"D x 33"H	Set	1
30147	14 oz Pedestal Base 24"W x 20"D x 33"H	Set	1



Plenty of storage space



Convenient storage compartment on service side

BENCHMARK USA™

POPCORN MACHINES



11087



11147



11087 & 11147



30087





POPCORN POPPERS



POP-8R

SHOWTIME!™ RED POPCORN MACHINE

It's ShowTime!™. Attractive, fun graphics and vibrant colors draw in popcorn profits.

- ◆ Removable non-stick 8 oz stainless steel kettle with twist-lock disconnect
- ◆ Independent illuminated control switches for Light, and Heat, Turn (motor)
- ◆ Front & side tempered glass panels
- ◆ Rear clear plexiglass door(s)
- ◆ Mirror polished stainless steel fold-out tray for easy access
- ◆ Built in warmer light
- ◆ Under-deck warming element
- ◆ Removable unpopped kernel tray

OVERALL DIMENSIONS L" X D" X H" (mm)	POWER	PLUG	SHIP WEIGHT
22 x 16-½ x 30 (559 x 420 x 762)	110V-60Hz, 1320W, 12A	NEMA 5-15P	55.1 lbs (25 kgs)



ITEM	DESCRIPTION	UOM	CASE
POP-8R	Red Popcorn Popper, Teflon® Coated Non-Stick Kettle	Set	1
POP8-P1	Replacement Non-stick Kettle	Each	1

Cart features same fun decal as POP-8R



POP-8RC

SHOWTIME!™ RED POPCORN MACHINE CART

- ◆ Allows the (POP-8R) Popcorn Machine to be portable
- ◆ Ideal where counterspace is limited
- ◆ 23-1/2" spoked wheels with inflatable rubber tires and sturdy handle for easy transport
- ◆ Convenient compartment on operator-side for storage and additional work space
- ◆ Overall Dimensions: 36-7/8"L x 22-3/4"D x 34-5/8"H



ITEM	DESCRIPTION	UOM	CASE
POP-8RC	Red Cart for POP-8R	Set	1
POP-8RC-D	Yellow "POPCORN" Decal	Each	1

Traditional-style decal option

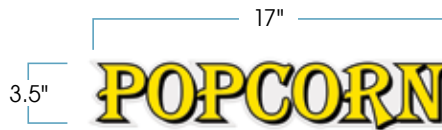

POP-8RC-D



Storage compartment

SHOWTIME!™ BLACK POPCORN MACHINE

It's ShowTime!™. Attractive, fun graphics and vibrant colors draw in popcorn profits.

- ◆ Removable 8 oz stainless steel kettle with twist-lock disconnect
- ◆ Independent illuminated control switches for Light, Heat, Turn (motor), and Power
- ◆ Front & side tempered glass panels
- ◆ Rear clear plexiglass door(s)
- ◆ Mirror polished stainless steel fold-out tray for easy access
- ◆ Built in warmer light
- ◆ Under-deck warming element
- ◆ Removable unpopped kernel tray

OVERALL DIMENSIONS L" X D" X H" (mm)	POWER	PLUG	SHIP WEIGHT
17-¾ x 14-¾ x 23-½ (450 x 375 x 597)	110V-60Hz, 1150W, 9.5A	NEMA 5-15P	40.8 lbs (18.5 kgs)



ITEM	DESCRIPTION	UOM	CASE
POP-8B	Black Popcorn Popper	Set	1
POP8-P2	Replacement Kettle for POP-8B	Each	1



POPCORN POPPERS



ULTRA-BRIGHT "POPCORN" LED SIGN

Extremely bright and eye-catching in any environment, with simple, attractive, colorful graphics.

- ◆ 12V vivid LED back-light
- ◆ Durable extruded aluminum frame
- ◆ Hangs flat against the wall
- ◆ Environmentally friendly

ITEM	DESCRIPTION	UOM	CASE
92001	UltraBright Sign - Popcorn 16"W x 1-¼"D x 12"H	Each	5



POPCORN SIGN



POPCORN ACCESSORIES

ITEM	DESCRIPTION	UOM	CASE
MCP-4P	Measuring Cup Set, 4-pcs, Wire Handle, S/S	Set	12/48
PS-20	20 oz PC Scoop, Clear	Each	24/144
CR-890W	Bar Maid® Popcorn / Fry Scoop, White, PC	Each	1/12
42030	Aluminum Speed Scoop	Each	50
72301	Toz Pump	Each	1

POPCORN SUPPLIES



72301



MCP-4P



PS-20



CR-890W



The product & package images shown are for illustration purposes and may differ from actual.





POPCORN SUPPLIES



40004
40006
40008

UNPOPPED TO POPPED KERNEL CONVERSION					
UNPOPPED KERNELS			POPPED POPCORN		
1 oz	2 Tbsp	1/8 cup	32 oz	1 Qt	4 cups
4 oz		1/2 cup	128 oz	4 Qts	16 cups
6 oz		3/4 cup	192 oz	6 Qts	24 cups
8 oz		1 cup	256 oz	8 Qts	32 cups

POPCORN PORTION PACKS

ITEM	DESCRIPTION	UOM	CASE
40004	4oz - 24 packs/case	Case	1
40006	6oz - 24 packs/case	Case	1
40008	8oz - 24 packs/case	Case	1



40508

BULK UNPOPPED POPCORN KERNEL BAG

ITEM	DESCRIPTION	UOM	CASE
40507	12.5 lb Bag - 4 Bags/Case	Case	1



Popcorn kernels, oils, & flavorings!

POPCORN POPPING OILS

ITEM	DESCRIPTION	UOM	CASE
40012	Canola Oil - Gallon	Each	4
40011	Coconut Oil - Gallon	Each	1
40015	Coconut Oil - 50 lb Pail	Each	1



40015



40011



40012

POPCORN FLAVORINGS

ITEM	DESCRIPTION	UOM	CASE
40010	Buttery Salt - 35oz	Each	12
40017	Buttery Topping - 1 Gallon	Each	4
40021	Caramel Corn Glaze - 28oz	Each	12
40023	Cheddar Cheese Mix - 1 Gallon	Each	1



40010



40021



40017



40023

The product & package images shown are for illustration purposes and may differ from actual.

POPCORN PAPER BAGS

ITEM	DESCRIPTION	DIMENSIONS	PCS/CASE	UOM	CASE
41001	1oz	2" x 3.5" x 8"	1,000	Case	1
41002	1.5oz	2.5" x 4" x 8.25"	1,000	Case	1
41003	2oz	5.25" x 12"	1,000	Case	1



POPCORN SUPPLIES



4100X SERIES

POPCORN BUTTER BAGS

ITEM	DESCRIPTION	DIMENSIONS	PCS/CASE	UOM	CASE
41232CS	32oz, Red	4.25"L x 2.5"W x 7"H	1,000	Case	1
41246CS	46oz, Orange	4.5"L x 2.5"W x 8.25"H	1,000	Case	1
41285CS	85oz, Blue	5"L x 3.5"W x 9.5"H	1,000	Case	1
41230CS	130oz, Green	6"L x 3.75"W x 10.5"H	500	Case	1
41270CS	170oz, Purple	7.5"L x 3.75"W x 10.75"H	500	Case	1



412XXCS SERIES

POPCORN TAPERED SCOOP BOXES

ITEM	DESCRIPTION	DIMENSIONS	PCS/CASE	UOM	CASE
41044CS	0.75oz	3.5"W x 3.5"D x 6"H	500	Case	1
41047CS	1.25oz	3.5"W x 3.5"D x 7.5"H	500	Case	1
41048CS	2.5oz	4"W x 4"D x 8"H	500	Case	1



4104XCS SERIES

CLOSED-TOP POPCORN BOXES

ITEM	DESCRIPTION	DIMENSIONS	PCS/CASE	UOM	CASE
41549CS	0.75oz	4"W x 2"D x 6.5"H	500	Case	1
41557CS	0.95oz	4.25"W x 2"D x 7"H	500	Case	1
41563CS	1.25oz	4.75"W x 2"D x 7.5"H	500	Case	1
41569CS	2.0oz	5.75"W x 2"D x 8.5"H	500	Case	1
41574CS	2.5oz	5.75"W x 2.5"D x 8.5"H	250	Case	1



415XXCS SERIES

POPCORN TUBS

ITEM	DESCRIPTION	DIMENSIONS (W = AT TOP)	PCS/CASE	UOM	CASE
41432CS	32oz	4.5"W x 5.75"H	500	Case	1
41446CS	46oz	4.75"W x 7"H	600	Case	1
41485CS	85oz	7"W x 6.5"H	300	Case	1
41430CS	130oz	7.5"W x 8.25"H	300	Case	1
41470CS	170oz	7.5"W x 10"H	150	Case	1



414XXCS SERIES

The product & package images shown are for illustration purposes and may differ from actual.





COTTON CANDY MACHINES & SUPPLIES

60 cones per hour



81011A



81011A

ZEPHYR™ COTTON CANDY MACHINE - PORTABLE

Easy to operate and produce up to 60 cones per hour, great for "on demand" service.

- ◆ Lightweight design with two handles for easy transport
- ◆ Stainless steel 20-1/2" dia bowl locks securely onto base
- ◆ Spinner head easily removes for cleaning
- ◆ Low vibration 1.2hp heavy-duty belt drive motor and replacement belt

ITEM	OVERALL DIMENSIONS L" X D" X H" (mm)	POWER	PLUG	SHIP WEIGHT
81011A	21 x 21 x 16 (534 x 534 x 406)	120V~60Hz, 1080W, 9A	NEMA 5-15P	28 lbs (12.7 kgs)

ITEM	DESCRIPTION	UOM	CASE
81011A	Zephyr Cotton Candy Machine	Set	1
CCM-28C	Clear Plastic Dome Cover 21"Dia x 14"H	Each	1/5

Includes floss sugar scooper



30090

ZEPHYR™ COTTON CANDY MACHINE CART

Stylish and convenient cotton candy trolley with ample work space and storage.

- ◆ Fits the Zephyr cotton candy machine
- ◆ Operator side storage shelf
- ◆ 3 cone holders integrated on side shelf

ITEM	DESCRIPTION	UOM	CASE
30090	Cart, 60" L x 24" D x 32" H	Set	1

Integrated cone holders



8200XCS-SERIES



COTTON CANDY SUGAR FLOSS

- ◆ 6 cartons/case

ITEM	DESCRIPTION	UOM	CASE
82001CS	Blue Raspberry 3.25lb carton	Case	1
82002CS	Bubblegum 3.25lb carton	Case	1
82003CS	Cherry 3.25lb carton	Case	1
82004CS	Grape 3.25lb carton	Case	1
82005CS	Pink Vanilla 3.25lb carton	Case	1
82006CS	Strawberry 3.25lb carton	Case	1



83005



COTTON CANDY PAPER CONES

ITEM	DESCRIPTION	UOM	CASE
83005	1,000 Cones/Pack	Pack	1



83001CS

COTTON CANDY POLY BAGS

ITEM	DESCRIPTION	UOM	CASE
83001CS	Poly Bags -1,000 Bags/Case	Case	1

The product & package images shown are for illustration purposes and may differ from actual.



SHOWTIME!™ COTTON CANDY MACHINES

It's ShowTime!™. Attractive, fun graphics and vibrant colors draw in cotton candy profits.

- ◆ Simple, easy-to-use controls; makes 120 cones per hour
- ◆ Stainless steel 20-1/2" dia bowl locks securely onto base
- ◆ Large capacity built-in stainless steel supply drawer
- ◆ Spinner head holds 4oz of sugar and releases floss vertically, which prevents clogging
- ◆ Low vibration 1.5hp heavy-duty belt drive motor and two (2) replacement belts
- ◆ Easy access to voltage meter and fuse for use with generators and power supplies

COTTON CANDY MACHINES



CCM-28C
Dome Cover
sold separately

120 cones
per hour



SHOWTIME!™ COTTON CANDY MACHINE

OVERALL DIMENSIONS L" X D" X H" (mm)	POWER	PLUG	SHIP WEIGHT
20½ x 20½ x 18½ (520 x 520 x 480)	110V-60Hz, 1080W, 9A	NEMA 5-15P	33 lbs (15 kgs)

ITEM	DESCRIPTION	UOM	CASE
CCM-28	Cotton Candy Machine	Set	1

Includes floss sugar scooper

SHOWTIME!™ COTTON CANDY MACHINE WITH CART

- ◆ High polished push handle and spoked wheels
- ◆ 13" inflatable rubber tires for easy transport
- ◆ Two (2) side shelves for merchandising product (each shelf measures 11" x 12-5/8"); one side with handle and other with slots to hold cones

OVERALL DIMENSIONS L" X D" X H" (mm)	POWER	PLUG	SHIP WEIGHT
37¾ x 20½ x 34½ (959 x 520 x 876)	110V-60Hz, 1080W, 9A	NEMA 5-15P	49.6 lbs (22.5 kgs)

ITEM	DESCRIPTION	UOM	CASE
CCM-28M	Cotton Candy Machine with Cart	Set	1



SHOWTIME!™ COTTON CANDY MACHINE ACCESSORIES

- ◆ Optional clear cover protects the bowl from wind & debris

ITEM	DESCRIPTION	UOM	CASE
CCM-28C	Clear Plastic Dome Cover 21"Dia x 14"H	Each	1/5
CCM28-P3	Replacement Belt	Each	1
CCM28-P5	Sugar Spoon	Each	1



CCM28-P10
Shown in CCM-28M

COTTON CANDY MACHINE FLOSS STABILIZER

- ◆ Optional floss stabilizer adds texture to the inside of the bowl and helps catch floss on its mesh surface

ITEM	DESCRIPTION	UOM	CASE
CCM28-P10	Floss Stabilizer	Each	1



CCM28-P10

ULTRA-BRIGHT "COTTON CANDY" LED SIGN

ITEM	DESCRIPTION	UOM	CASE
92005	Ultra-Brite Sign - Cotton Candy 12"L x 1-1/4"D x 21"H	Each	5

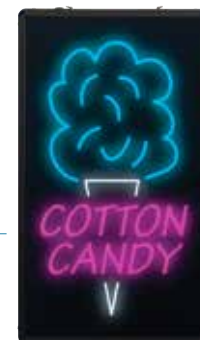

92005



SNOW CONE MACHINES

500lbs of ice per hour



CE
ETL US ETL Intertek Intertek
71000



30070



CE
ETL US ETL Intertek Intertek
71050



74001

SNOW CONE MACHINES

Durable and efficient, the high-volume output keeps up with busy snack bars, convenience stores, and concession stands.

- ◆ Heavy-duty 1/3hp 1700RPM motor produces up to 500 lbs (227kg) of shaved ice per hour
- ◆ Accepts cubed or chunk ice
- ◆ Cast aluminum horn, cutting head, pusher
- ◆ Adjustable stainless steel cutting blades for fine or coarse shaved ice
- ◆ Pulse-type safety reset switch prevents accidental start-up

"SNOW BANK" SNOW CONE MACHINE

- ◆ Tinted tempered glass panels
- ◆ Stainless steel cabinet with tempered glass panels
- ◆ Built-in snow cone shaper for perfect snow cones
- ◆ Plexiglass service door and molded plastic drainage deck with drain hose

OVERALL DIMENSIONS L" X D" X H" (mm)	POWER	PLUG	SHIP WEIGHT
16 x 16 x 24 (407 x 407 x 610)	120V-60Hz, 250W, 2.08A	NEMA 5-15P	62 lbs (28.1 kgs)

ITEM	DESCRIPTION	UOM	CASE
71000	Snow Bank Professional Snow Cone Machine	Set	1

"SNOW BANK" SNOW CONE CART

- ◆ Add mobility to "Snow Bank" snow cone machine
- ◆ Spoked wheels and sturdy handle for easy transport
- ◆ Shelf and operator side storage

ITEM	DESCRIPTION	UOM	CASE
30070	Cart for Snow Bank Snow Cone Machine 38"L x 23"D x 33"H	Set	1

"SNOW BLITZ" SNOW CONE MACHINE - PORTABLE

- ◆ Compact heavy-duty stainless steel construction
- ◆ Integrated carry handles for easy transport
- ◆ Includes 1 freezer-safe ice tote

OVERALL DIMENSIONS L" X D" X H" (mm)	POWER	PLUG	SHIP WEIGHT
22-7/8 x 18 x 18-1/2 (580 x 456 x 470)	120V-60Hz, 250W, 2.08A	NEMA 5-15P	58 lb (26.3 kgs)

ITEM	DESCRIPTION	UOM	CASE
71050	Snow Blitz Portable Snow Cone Machine	Set	1
74001	Ice Tote Box 20.5"L x 15.3"D x 7"H	Each	1

The product & package images shown are for illustration purposes and may differ from actual.

SNOW CONE SYRUPS - 1 GALLON

◆ 4 gallons/case

ITEM	DESCRIPTION	UOM	CASE
72001CS	Blue Raspberry	Case	1
72002CS	Cherry	Case	1
72003CS	Grape	Case	1
72004CS	Lemon	Case	1
72005CS	Lime	Case	1
72006CS	Strawberry	Case	1
72007CS	Red Raspberry	Case	1
72008CS	Bubblegum	Case	1
72009CS	Green Apple	Case	1
72010CS	Root Beer	Case	1
72011CS	Orange	Case	1
72012CS	Fuzzy Navel	Case	1
72301	1 oz Pump for Syrup	Each	1

**BENCH
MARK USA**

SNOW CONE SUPPLIES



72002CS



72001CS



72301



72005CS



72004CS



72012CS

SNOW CONE ACCESSORIES

ITEM	DESCRIPTION	UOM	CASE
72305	Snow Cone Scoop, S/S	Each	1
72401CS	Snow Cone Spoon Straws (assorted colors), 10,000 pcs/case	Case	1
72501	6 oz Paper Snow Cone Cups 1,000 pcs/pack	Pack	1
72701	Snow Cone Paper Cup Dispenser	Each	1

Syrups,
pumps, cups,
scoops, &
straws!



72701

Shown with 6oz paper cups (sold separately)



72305



72401CS



72501

ULTRA-BRIGHT "SNOWCONES" LED SIGN

ITEM	DESCRIPTION	UOM	CASE
92003	Ultra-Brite Sign - Snowcones 17"L x 1-1/4"D x 13"H	Each	5



92003

The product & package images shown are for illustration purposes and may differ from actual.



winco
SPECTRUM™
 HOT DOG ROLLER GRILLS
 & SNEEZE GUARDS



EHDG-5R



EHDG-11R



EHDG-7R &
EHDG-7SG



EHDG-R-SERIES



EHDG-5SG

ROLLSRIGHT™ COUNTERTOP HOT DOG ROLLER GRILLS

A great addition to any quick service establishment. Dual temperature controls allow for both cooking and holding areas to operate independently, reducing waste and spoilage due to excessive overheating. The RollRight™ non-stick roller surfaces stand up to continual use and are easy to clean. This versatile machine is also great for egg rolls, taquitos, sausages, and more!

- ◆ Easy-to-clean non-stick rollers; sealed ends protect internal parts
- ◆ Heavy-duty sealed motor
- ◆ Bike chain and sprocket drive assembly
- ◆ Two independent thermostatic heat controls (front & rear)
- ◆ Individual heating element in each roller for end to end temperature consistency
- ◆ Heavy duty stainless steel body and drip pan
- ◆ Re-settable fuse for safety
- ◆ Non-skid rubber feet
- ◆ Cooking surface holds up to 12 hot dogs (-5R), 18 hot dogs (-7R) and 30 hot dogs (-11R)

ITEM	OVERALL DIMENSIONS L" X D" X H" (mm)	POWER	PLUG	SHIP WEIGHT
EHDG-5R	23 x 10-½ x 7 (585 x 270 x 180)	110V~60Hz, 700W, 6.3A		17.2 lbs (7.8 kgs)
EHDG-7R	23 x 13-½ x 7 (585 x 345 x 180)	110V~60Hz, 900W, 8.1A	NEMA 5-15P	20.9 lbs (9.5 kgs)
EHDG-11R	23 x 19-¾ x 7 (585 x 505 x 180)	110V~60Hz, 1400W, 12.7A		29.7 lbs (13.5 kgs)

ITEM	DESCRIPTION	UOM	CASE
EHDG-5R	Hot Dog Roller, 5 Rollers	Set	1
EHDG-7R	Hot Dog Roller, 7 Rollers	Set	1
EHDG-11R	Hot Dog Roller, 11 Rollers	Set	1
EHDG-P10	Replacement Knob for EHDG-Series	Each	1



EHDG-11R & EHDG-11SG

SNEEZE GUARDS FOR HOT DOG ROLLER GRILLS

- ◆ Increase sanitation and protect food from airborne contaminants with customer-facing sneeze guards
- ◆ Durable, curved tempered glass allows customers a direct view of available food options

ITEM	DESCRIPTION	UOM	CASE
EHDG-5SG	Fits EHDG-5R	Each	1
EHDG-7SG	Fits EHDG-7R	Each	1
EHDG-11SG	Fits EHDG-11R	Each	1

BENCHMARK HOT DOG ROLLER GRILLS

These high quality roller grills are available in 10, 20 & 30 hot dog capacities to meet any application. Stainless steel construction, removable drip trays and non-stick rollers ensure ease of cleaning. All of these grills feature a high-torque motor. 360 degree roller rotation insures evenly cooked hotdogs.

- ◆ Heavy-duty stainless steel body and removable drip tray for easy cleaning
- ◆ Heavy-duty sealed high-torque motor with bicycle chain drive
- ◆ Stainless steel non-stick rollers with sealed ends and continuous 360 degree rotation for even cooking
- ◆ Front and rear heat controllers (on 20 & 30 dog models) for cooking and holding options
- ◆ Accommodates any size hot dog, also sausage or breakfast links for expanded offerings

ITEM	OVERALL DIMENSIONS L" X D" X H" (mm)	POWER	PLUG	SHIP WEIGHT
62010	16 x 13 x 8 (407 x 330 x 203)	120V~60Hz, 660W, 5.5A		22 lbs (10 kgs)
62020	22 x 16 x 8 (559 x 406 x 203)	120V~60Hz, 860W, 7.2A	NEMA 5-15P	29 lbs (13.2 kgs)
62030	22 x 20 x 8 (559 x 508 x 203)	120V~60Hz, 1160W, 9.7A		35 lbs (15.9 kgs)

ITEM	DESCRIPTION	UOM	CASE
62010	Holds 10 Dogs	Set	1
62020	Holds 20 Dogs	Set	1
62030	Holds 30 Dogs	Set	1



62020, 64020, 65020

BENCHMARK USA™

HOT DOG ROLLER GRILLS & SNEEZE GUARDS



62010



62020



62030



Intertek

62010

62020

62030

BENCHMARK HOT DOG ROLLER SNEEZE GUARDS

ITEM	DESCRIPTION	UOM	CASE
64010	Sneeze Guard for 10 Dog Roller Grill	Set	10
64020	Sneeze Guard for 20 Dog Roller Grill	Set	10
64030	Sneeze Guard for 30 Dog Roller Grill	Set	10



64010

BENCHMARK HOT DOG ROLLER BUN DRAWERS - UNHEATED

ITEM	DESCRIPTION	UOM	CASE
65010	Bun Box for 10 Dog Roller Grill	Set	1
65020	Bun Box for 20 Dog Roller Grill	Set	1
65030	Bun Box for 30 Dog Roller Grill	Set	1



65010

The product & package images shown are for illustration purposes and may differ from actual.





HOT DOG EQUIPMENT



THE DOG HOUSE HOT DOG COOKER & DISPENSER

Cooks, merchandises, and dispenses hot dogs in a space-efficient 15" footprint. The Doghouse minimizes product waste and is extremely easy to use and clean.

- ◆ Easy to follow Point-of-Sale graphic allows for full service or self service operation
- ◆ Steam cooks up to 24 hot dogs in 20-30 minutes
- ◆ Holds up to 24 hot dogs and 44 buns
- ◆ Compact all stainless steel construction - requires only 15" of counter space
- ◆ No tools required for fast breakdown, easy to clean
- ◆ Adjustable thermostat for precise cooking
- ◆ First-in first-out dispensing
- ◆ Large 10Qt (9.5L) water reservoir, with low-water indicator light and safety shutoff



Holds 24 hot dogs and 44 buns

OVERALL DIMENSIONS L" X D" X H" (mm)	POWER	PLUG	SHIP WEIGHT
15 x 23 x 26 (381 x 584 x 664)	120V-60Hz, 1000W, 8.33A	NEMA 5-15P	43 lbs (19.5 kgs)

ITEM	DESCRIPTION	UOM	CASE
60024	The Dog House Hot Dog Cooker & Dispenser	Set	1

Dispense a hot dog right into the bun!



Remove a bun from the bun drawer



Place the open bun in the bun tray



Gently pull lever to dispense a hot dog into the bun

CE
ETL Intertek
ETL Intertek
60024

THE DOG POUND HOT DOG STEAMER

Ideal for convenience stores, concession stands, snack bars, and cafeterias.

- ◆ Steams and holds 164 hot dogs and 36 buns
- ◆ Graphics on each side allow for front or rear counter merchandising
- ◆ Adjustable thermostat accommodates a variety of products and cooking conditions
- ◆ 7Qt (6.6L) water reservoir, with low-water indicator light and safety shutoff
- ◆ Tempered glass doors and food trays are removable for easy cleaning

Holds 164 hot dogs and 36 buns



OVERALL DIMENSIONS L" X D" X H" (mm)	POWER	PLUG	SHIP WEIGHT
15 x 16 x 19 (381 x 407 x 483)	120V-60Hz, 1000W, 8.33A	NEMA 5-15P	31 lbs (14.1 kgs)

ITEM	DESCRIPTION	UOM	CASE
60048	Dog Pound Hot Dog Steamer	Set	1



CE
ETL Intertek
ETL Intertek
60048

MINI CART HOT DOG STEAMER, 120V

Guaranteed to grab your guests' attention, this unit features wheels and an umbrella that mimic the carts found along vibrant city streets.

- ◆ Holds 60 hot dogs and 30 buns
- ◆ Mirror finish 18/8 stainless steel body
- ◆ Adjustable thermostat for cooking and holding
- ◆ Includes 1 solid half-size pan with domed lid for warming buns and 1 half-size perforated pan with flat lid for steaming hot dogs
- ◆ Outfitted with Point-of-Sale graphics, umbrella, wheels

OVERALL DIMENSIONS L" X D" X H" (mm)		POWER	PLUG	SHIP WEIGHT
21-1/2 x 13-1/4 x 16 (546 x 336 x 406) Umbrella: 35-3/4"H (908mm)		120V-60Hz, 1200W, 10A	NEMA 5-15P	33 lbs (15 kg)

ITEM	DESCRIPTION	UOM	CASE
60072	Mini Cart Hot Dog Steamer	Set	1

BENCHMARK USA™

HOT DOG EQUIPMENT



Holds 60 hot dogs and 30 buns



STAINLESS STEEL CONDIMENT STATION / DISPENSER

- ◆ Insulated condiment rail and stay-open cover
- ◆ Pump wells fit #10 cans, 1.5 gallon containers, or 3qt jars
- ◆ Includes 2 ice packs, 2 pumps, & 3 ninth-size 4" deep pans

ITEM	DESCRIPTION	UOM	CASE
52001	Benchmark Condiment Station / Dispenser 27"L x 8"D x 15"H	Set	1



52001

18/8 STAINLESS STEEL CONDIMENT DISPENSER

- ◆ Two (2) 3-1/2 Qt plastic fountain jars included (7 Qt total)
- ◆ Each pump dispenses between 1 oz and 1-1/4 oz portions, depending on thickness of condiments
- ◆ Overall dimensions: 11"L x 8-3/4"W x 16"H (with pump)

ITEM	DESCRIPTION	UOM	CASE
PKTS-2D	Condiment Dispenser with 2 Standard Pumps	Set	1
PKTS-PT01	Individual Pump with Lid	Each	20
PKTS-PT02	Replacement Plastic Fountain Jar	Each	6
PKTS-PT03	Stainless Steel Casing	Each	1



PKTS-2D

PKTS-SERIES

BPA FREE

HOT DOG ACCESSORIES

ITEM	DESCRIPTION	PCS/CASE	UOM	CASE
PT-9	9" Pom Tongs, S/S		Doz	4/24
67002	Stainless Steel Tongs Holder		Each	50
68001CS	Paper Hot Dog Bags	5,000	Case	1
68002	Foil Hot Dog Bags	1,000	Case	1
68004CS	Fluted Paper Hotdog Trays	3,000	Case	1



68001CS



68002



68004CS



PT-9 & 67002

ULTRA-BRIGHT "HOTDOGS" LED SIGN

ITEM	DESCRIPTION	UOM	CASE
92002	Ultra-Brite Sign - Hotdogs 20"L x 1-1/4"D x 13"H	Each	5



92002





NACHO WARMERS & SUPPLIES



51000

100 QUART FOOD WARMER / MERCHANDISER

Holds and warms nacho chips, peanuts, or popcorn

- ◆ 100 quart capacity for large or small batch use
- ◆ Merchandising signs include: "Nacho Chips", "Peanuts", and "Popcorn". Signs mount to front or back of unit
- ◆ Top-load door with a deflection board that prevents product breakage when refilling
- ◆ Built-in heating element in the base keeps contents warm and fresh
- ◆ Aluminum and tempered glass construction for durability and easy cleaning

OVERALL DIMENSIONS L" X D" X H" (mm)	POWER	PLUG	SHIP WEIGHT
15 x 15 x 30-1/2 (381 x 381 x 775)	120V-60Hz, 100W, 0.83A	NEMA 5-15P	41 lbs. (18.6 kgs)

ITEM	DESCRIPTION	UOM	CASE
51000	100 Quart Food Warmer / Merchandiser with Three Signs	Set	1



51026

26 GALLON TORTILLA CHIP WARMER

- ◆ Large 26 gallon (98L) capacity
- ◆ Insulated stainless steel construction
- ◆ Adjustable thermostat with 90°-180°F (32°-82°C) temperature range
- ◆ Digital temperature indicator
- ◆ Convection heating fan
- ◆ Removable front access service door
- ◆ Top-load double hinged doors
- ◆ Adjustable 4" legs

OVERALL DIMENSIONS L" X D" X H" (mm)	POWER	PLUG	SHIP WEIGHT
23 x 23 x 29 (584 x 584 x 734)	120V-60Hz, 755W, 6.3A	NEMA 5-15P	77 lbs (35 kgs)

ITEM	DESCRIPTION	UOM	CASE
51026	26 Gallon Tortilla Chip Warmer	Set	1



47001 Note: serving tray style may vary from shown

53021

NACHO ACCESSORIES

ITEM	DESCRIPTION	PCS/PACK	UOM	CASE
47001	Combo Serving Trays	250	Case	1
53021	Plastic Nacho Trays, 5" x 6"	500	Case	1



92004

ULTRA-BRIGHT "NACHOS" LED SIGN

ITEM	DESCRIPTION	UOM	CASE
92004	Ultra-Brite Sign - Nachos 16"L x 1-1/4"D x 17"H	Set	5

PASS-THROUGH TWO-DOOR WARMERS/ MERCHANDISERS

These versatile 2-Door Warmers /Merchandisers are ideal for front or rear counter applications. The operator side has the controls and a door for easy loading. The customer side door makes it a self-serve unit.

- ◆ Two doors for front or rear counter applications
- ◆ Attractive graphics for point-of-sale merchandising

PASS-THROUGH ROTATING DISPLAY WARMERS/MERCHANDISERS

- ◆ Heated cabinet with passive humidity control
- ◆ Stainless steel and tempered glass
- ◆ Adjustable thermostat with cabinet temperature readout
- ◆ Dual fixture interior illumination (bulbs not included)
- ◆ Includes chrome-plated 5-tier round pan rack (pizza) and hook rack (pretzels, churros)
- ◆ Continuous rotating rack stops when either door opens
- ◆ Adjustable 4" legs

ITEM	OVERALL DIMENSIONS L" X D" X H" (mm)	POWER	PLUG	SHIP WEIGHT
51012	18-1/8 x 22 x 33 (460 x 559 x 838)	120V-60Hz, 1560W, 13A	NEMA 5-15P	86 lbs (39 kgs)
51018	24-1/2 x 27 x 33 (622 x 686 x 838)			117 lbs (53.1 kgs)

ITEM	DESCRIPTION	UOM	CASE
51012	12" Warmer/Merchandiser	Set	1
51018	18" Warmer/Merchandiser	Set	1

BENCH MARK USA™ HEATED DISPLAY MERCHANDISERS



51012
Shown with
12" hook rack
installed



51018
Shown with 18"
pizza round rack
installed



51012
51018

PASS-THROUGH WARMERS/MERCHANDISERS

- ◆ Adjustable thermostat, 450 watt element
- ◆ Stainless steel and aluminum construction
- ◆ Tempered glass panels and doors
- ◆ Chrome-plated racks with adjustable installation - either lay flat or slanted

ITEM	OVERALL DIMENSIONS L" X D" X H" (mm)	POWER	PLUG	SHIP WEIGHT
51040	16 x 16 x 23 (407 x 407 x 584)	120V-60Hz, 600W, 5A	NEMA 5-15P	40 lbs (18.2 kgs)
51048	23 x 23 x 25½ (584 x 584 x 648)			62 lbs (28.1 kgs)

ITEM	DESCRIPTION	UOM	CASE
51040	12" Warmer/Merchandiser	Set	1
51048	18" Warmer/Merchandiser	Set	1



51040
Fits up to 12"
diameter pizza



51048
Fits up to 18"
diameter pizza



51040
51048

ULTRA-BRITE "PIZZA" LED SIGN

ITEM	DESCRIPTION	UOM	CASE
92006	Ultra-Brite Sign - Pizza	Each	5



92006

HEATED DISPLAY MERCHANDISERS



EDM-1K
Matte Black
(Single Door)



Control Panel

HEATED & HUMIDIFIED HOLDING DISPLAY MERCHANDISERS

Keep hot foods fresher for longer with this heat and humidity controlled merchandiser. The airflow pattern is designed to maintain consistent temperature and humidity around foods and prevent drying, which also enables the unit to recover temperature quickly after doors are opened/closed.

- ◆ Powder-coated exterior, stainless steel interior
- ◆ Clear-view tempered glass on all sides, with server-side easy access swing door
- ◆ LED interior illumination provides optimal visibility
- ◆ Digital adjustable thermostat and humidity control
- ◆ Temperature range: 89°F to 194°F (30°C to 90°C)
- ◆ Optional pretzel rack insert available, sold separately

EDM-1K MATTE BLACK

- ◆ Server-side easy access swing door
- ◆ 4-tier round rack continuously rotates - rotation stops when door is opened
- ◆ Each shelf fits up to 18" diameter pan

EDM-1PT RED

- ◆ 2 pass-through swing doors
- ◆ Rotating motor to accept optional round rack
- ◆ 3 display shelves showcase food products

ITEM	OVERALL DIMENSIONS L" X D" X H" (mm)	POWER	PLUG	SHIP WEIGHT
EDM-1K	23-5/8 x 25-3/8 x 27-9/16 (600 x 643 x 700)	120V-60Hz, 1500W, 13.1A	NEMA 5-15P	85 lbs (38.6 kgs)
EDM-1PT	23-5/8 x 26 x 27-9/16 (600 x 660 x 700)			



EDM-1PT
Red
(Double Door)



2 pass-through
swing doors



ITEM	DESCRIPTION	UOM	CASE
EDM-1K	Merchandiser, 1 Door, Black	Set	1
EDM-1PT	Merchandiser, 2 Doors, Red	Each	1
EDM-P39	4-Tier Round Rack, 18" Dia	Each	5
EDM-1PR	Pretzel Rack for EDM-1K	Each	1
EDM1-P36	Display Shelf Kit (3 Shelves & 12 Shelf Clips) fits EDM-1K or EDM-1PT	Pack	1



EDM-1PR
Optional Pretzel Rack



EDM-1K
EDM-1PT



New Item

ELECTRIC HEATED PIZZA/PRETZEL MERCHANDISERS

Passive humidity control with removable water tray.

- ◆ Interior wire shelves hold four (4) 14" pizzas
- ◆ Optional pretzel rack insert, sold separately
- ◆ Display tray/rack insert rotates when door is closed
- ◆ Lighted display panel for branding visuals
- ◆ Adjustable thermostat from 85°F to 195°F (30°C to 90°C)
- ◆ Removable crumb tray

OVERALL DIMENSIONS L" X D" X H" (mm)	POWER	PLUG	SHIP WEIGHT
18-3/8 x 17-5/8 x 31 (466 x 447 x 785)	110-120V~60Hz, 786W, 7.2A	NEMA 5-15P	55.2 lbs (25 kgs)



ITEM	DESCRIPTION	UOM	CASE
EDM-2	Heated Pizza/Pretzel Merchandiser	Set	1
EDM-2PR	Optional Pretzel Rack Insert	Set	1
EDM-2PRS	Pretzel Sign, 5-3/4"H x 16-1/8"W	Each	1
EDM-2PZS	Pizza Sign, 5-3/4"H x 16-1/8"W	Each	1
EDM-P58	4-Tier Round Rack, 14" Dia	Each	5

Translucent plastic display sign options



EDM-2PRS



EDM-2PZS



EDM-2PR
Optional Pretzel Rack



Control Panel



EDM-2



Back-lit display (signs sold separately)

COUNTERTOP HEATED DISPLAY MERCHANDISERS

These merchandisers feature passive humidity control with a removable water tray.

- ◆ Removable water pan to add and control humidity
- ◆ Three (3) adjustable shelves inside, top of unit also functional as a shelf
- ◆ Lighted front display for branding visuals
- ◆ Visible thermometer gauge to ensure food keeps at proper temperatures
- ◆ Adjustable thermostat from 85°F to 195°F (30°C to 90°C)
- ◆ Customer-facing front service and rear access doors

ITEM	OVERALL DIMENSIONS L" X D" X H" (mm)	POWER	PLUG	SHIP WEIGHT
HDM-13	13-11/16 x 19-2/16 x 26-1/8 (347 x 495 x 663)	110-120V~60Hz, 800W, 7.6A	NEMA 5-15P	50.7 lbs (23 kgs)
HDM-26	26-11/16 x 19-2/16 x 26-1/8 (677 x 495 x 663)	110-120V~60Hz, 1000W, 9.5A		79.4 lbs (36 kgs)



ITEM	DESCRIPTION	UOM	CASE
HDM-13	13-1/2"L	Set	1
HDM-26	26-1/2"L	Set	1

HEATED DISPLAY MERCHANDISERS



HDM-13

Accepts 1/4-size sheet pans



HDM-26



Control Panel



HDM-SERIES



REFRIGERATED COLD BEVERAGE DISPLAY



CRD-1

CRD-Series uses environmentally friendly R290 refrigerant



CRD-1K

COUNTERTOP REFRIGERATED BEVERAGE DISPLAYS

With its clear panels and 4 LED light strips, this countertop display can keep up to 100 standard 12 oz cans chilled. These units use R290 refrigerant making them an environmentally-responsible choice.

- ◆ Digital temperature display from 32°F to 42°F (0°C - 6°C)
- ◆ R-290 environmentally safe refrigerant
- ◆ 360° view of refrigerated product
- ◆ 2 double, curved-glass doors for dual access and easy placement of inner contents
- ◆ 4 LED strips for effective product lighting
- ◆ Comfortably fits up to 100 cans (standard 12 oz) with 25 cans per shelf
- ◆ 4-level merchandising display; three (3) shelves are adjustable to fit multiple product heights
- ◆ Automatic defrost and ventilated cooling system

OVERALL DIMENSIONS L" X D" X H" (mm)	POWER	PLUG	SHIP WEIGHT
16¾ x 16 ¹⁵ / ₁₆ x 38½ (425 x 429 x 978)	110-120V~60Hz, 180W, 1.7A	NEMA 5-15P	85.89 lbs (39 kgs)
SHELF DIMENSIONS L" X D" (mm)			
14-3/8 x 12-1/8 (365 x 307)			

ITEM	DESCRIPTION	UOM	CASE
CRD-1	White	Set	1
CRD-1K	Black	Set	1

IMPORTANT
CRD-1 / -1K units are intended for use in commercial food-service operations, for display and cooling of sealed cold foods and cold beverages only.

Fits up to 100 cans



POWER & PERFORMANCE



High-performance motor with impact-resistant stainless steel blades adds power and performance to your busy establishment.

68 OZ (2 L) LARGE CAPACITY COMMERCIAL BLENDER

- ◆ 68 oz (2 L), break-resistant and BPA-free Tritan™ container
- ◆ High-performance 2 hp motor; unique high-impact blades
- ◆ Metal-to-metal coupling; easy to operate "PULSE"
- ◆ "ON /OFF" paddle controls & variable speed control dial
- ◆ Base footprint 9" x 10"
- ◆ Container/pitcher is heat-resistant up to 226°F (108°C); reduce pressure by removing cap in the lid
- ◆ Removable container cover and cap for adding/blending ingredients mid-cycle
- ◆ 11-1/2" tamper included - fits through lid opening and reaches full length of container to blend/stir while mixing
- ◆ All parts (except bases & blade fixing block) are dishwasher safe

OVERALL DIMENSIONS L" X D" X H" (mm)	POWER	PLUG	SHIP WEIGHT
8-11/16 x 9-13/16 x 19-15/16 (220 x 249 x 490)	120V~60Hz, 1450W, 12.1A	NEMA 5-15P	10.4 lbs (4.7 kgs)
CONTAINER DIMENSIONS L" X D" X H" (mm)			
6-11/16 x 6-11/16 x 12-3/8 (178 x 18 x 314)			

ITEM	DESCRIPTION	UOM	CASE
▶ XLB-1000	68 Oz Blender	Set	1/4
▶ XLB1000P2	Pitcher Assembly	Each	1
▶ XLB1000P19	Blade Removal Tool	Each	1

BLENDERS

Blade removal tool included



XLB1000P19

XLB-1000



TRITAN™ CONTAINER



44 OZ (1.25 L) 2-SPEED QUIET BAR BLENDER

- ◆ 44 oz (1.25 L), break-resistant and BPA-free Tritan™ container
- ◆ Quiet, high-performance 1/2 hp self-lubricating motor; uniquely designed high-impact blades
- ◆ HIGH/LOW toggle switch for precise consistency control
- ◆ Base footprint 6-1/2" x 8"
- ◆ Blade is removable for easy cleaning
- ◆ Non-skid feet securely grip the surface for stable operation
- ◆ Removable container cover and cap for adding/blending ingredients mid-cycle

OVERALL DIMENSIONS L" X D" X H" (mm)	POWER	PLUG	SHIP WEIGHT
7 x 7-7/16 x 15-7/16 (178 x 189 x 392)	120V~60Hz, 400W, 3.5A	NEMA 5-15P	5.5 lbs (2.5 kgs)
CONTAINER DIMENSIONS L" X D" X H" (mm)			
7x 8-1/8 x 9-7/16 (178 x 130 x 235)			

ITEM	DESCRIPTION	UOM	CASE
▶ XLB-44	44 Oz Blender	Set	1/4
▶ XLB44-P10	Pitcher Assembly	Each	1



XLB-44



TRITAN™ CONTAINER



ELECTRIC COFFEE URNS



ELECTRIC STAINLESS STEEL COFFEE URNS

Brew consistent, quality coffee with these percolating coffee urns. Available in either 50 or 100 cup capacities, contents are maintained at the ideal serving temperature until the sight glass indicates when it's time to refill.

- ◆ Large capacity brews 50 or 100 cups of 5oz (148ml) coffee
- ◆ Polished #304 stainless steel construction
- ◆ Twist-locking lid design
- ◆ Cool touch handles
- ◆ Dripless faucet with protected level indicator
- ◆ Waterproof ON/OFF switch with protective cover
- ◆ Stainless steel percolator pipe and plastic filter basket
- ◆ Heating and holding indicator lights
- ◆ Automatic shut-off safety feature



ECU-50A
ECU-100A



ECU-100A-I

ITEM	OVERALL DIMENSIONS L" X D" X H" (mm)	POWER	PLUG	SHIP WEIGHT
ECU-50A	12 x 8- ¹¹ / ₁₆ x 16- ³ / ₈ (304 x 220 x 415)	110-120V-60Hz, 950W, 8A	NEMA 5-15P	7.1 lbs (3.2 kgs)
ECU-100A	13- ¹⁵ / ₁₆ x 10- ⁵ / ₈ x 19- ¹¹ / ₁₆ (353 x 270 x 500)	110-120V-60Hz, 1500W, 12.5A		9.7 lbs (4.4 kgs)
ECU-100A-I		220-240V-50Hz, 1650W, 6.9-7.5A	VDE	9.7 lbs (4.4 kgs)

ITEM	DESCRIPTION	UOM	CASE
ECU-50A	50-Cup (8L)	Set	1/2
ECU-100A	100-Cup (16L)	Set	1/2
ECU-100A-I	100-Cup (16L), International	Set	1/2
EWCU-P3	Faucet Assembly	Each	1



Twist-locking lid



Cool-touch handles



Dripless faucet with clear-view level indicator



HOT BEVERAGE/TOPPING DISPENSER

This 5-quart capacity heated dispenser uses rotating paddles, making it perfect for nacho cheese, butter topping, hot chocolate, au jus, and more.

- ◆ 1.3 gallon (5L) capacity
- ◆ Removable, clear polycarbonate bowl, safe for refrigerated storage of unused product
- ◆ Easy-to-disassemble tap
- ◆ Adjustable thermostat up to 194°F (90°C)
- ◆ Rotating mixing paddles to prevent product separation
- ◆ Easy-to-clean removable drip tray
- ◆ Includes 2 replacement bowl sealing rings

OVERALL DIMENSIONS L" X D" X H" (mm)	POWER	PLUG	SHIP WEIGHT
10 x 13 x 20 (254 x 330 x 508)	120V~60Hz, 1100W, 9.2A	NEMA 5-15P	15 lbs (6.8 kgs)

ITEM	DESCRIPTION	UOM	CASE
21011	Hot Beverage/ Topping Dispenser	Each	1/2

BENCHMARK USA™

HOT BEVERAGE/ TOPPING DISPENSER



ETL
Intertek
21011

ELECTRIC STAINLESS STEEL WATER BOILERS

These water boilers are a great addition to any hot beverage service, heating and holding hot water ready to dispense as needed, until the sight glass indicates when it's time to refill.

- ◆ Large 2.1 gallon (8L) or 4.2 gallon (16L) capacities
- ◆ Polished #304 stainless steel construction
- ◆ Twist-locking lid design
- ◆ Cool touch handles
- ◆ Dripless faucet with protected level indicator
- ◆ Waterproof ON/OFF switch with protective cover
- ◆ Heating and holding indicator lights
- ◆ Automatic shut-off safety feature

ITEM	OVERALL DIMENSIONS L" X D" X H" (mm)	POWER	PLUG	SHIP WEIGHT
EWB-50A	12 x 8- ¹¹ / ₁₆ x 16- ³ / ₈ (304 x 220 x 415)	110-120V~60Hz, 1300W, 10.8A	NEMA 5-15P	6 lbs (2.7 kgs)
EWB-100A	13- ¹⁵ / ₁₆ x 10- ⁵ / ₈ x 19- ¹¹ / ₁₆ (353 x 270 x 500)	110-120V~60Hz, 1500W, 12.5A		8.4 lbs (3.8 kgs)
EWB-100A-I			220-240V~50Hz, 2250W, 9.4A	VDE

ITEM	DESCRIPTION	UOM	CASE
EWB-50A	2.1 Gallon (8L)	Set	1/2
EWB-100A	4.2 Gallon (16L)	Set	1/2
EWB-100A-I	4.2 Gallon (16L), International	Set	1/2
EWCU-P3	Faucet Assembly	Each	1

ELECTRIC WATER BOILERS



EWB-50A



EWB-100A
EWB-100A-I



Dripless faucet with
protected level
indicator



Cool-touch handles



Twist-locking lid

ETL
Intertek

EWB-50A
EWB-100A

CE
EWB-100A-I

ELECTRIC KETTLE SOUP WARMERS



ESW-70

The extra large kettle-style soup warmers keep contents at safe serving temperatures for hours, great for serving all day long.

- ◆ Up to 10-quart capacity
- ◆ Adjustable heat control keeps contents at a safe serving temperature without overcooking
- ◆ Stainless steel hinged lid features extra-large ladle slot; hinges allow cover to remain attached while opened and closed when in service with no drips
- ◆ Sets include a removable stainless steel bain marie inner pot
- ◆ Double-wall insulated construction allows outer surface to stay cool-to-touch

ELECTRIC STAINLESS STEEL KETTLE SOUP WARMER

- ◆ Includes suction-grip label holder

OVERALL DIMENSIONS L" x D" x H" (mm)	POWER	PLUG	SHIP WEIGHT
13- ³ / ₁₆ x 13- ³ / ₁₆ x 15 (335 x 335 x 381)	110V-50/60Hz, 400W, 3.6A	NEMA 5-15P	13.14 lbs (5.9 kgs)

ITEM	DESCRIPTION	UOM	CASE
ESW-70	S/S Kettle Soup Warmer Set	Set	1
ESW70-INS	S/S Insert for ESW-70	Each	2
INSH-7	Hinged Cover for ESW70-INS	Each	6/24
ESW70-P6	Replacement Knob	Each	1



ESW-66-I



ESW-66

ELECTRIC DELUXE BLACK KETTLE SOUP WARMER

- ◆ Includes customizable magnetic label holder, plus a variety of pre-printed soup name labels

ITEM	OVERALL DIMENSIONS L" x D" x H" (mm)	POWER	PLUG	SHIP WEIGHT
ESW-66	13- ³ / ₁₆ x 13- ³ / ₁₆ x 15 (335 x 335 x 381)	110V-50/60Hz, 400W, 3.6A	NEMA 5-15P	12.4 lbs (5.6 kgs)
ESW-66-I	13- ³ / ₁₆ x 13- ³ / ₁₆ x 15 (335 x 335 x 381)	220V-50/60 Hz, 500W, 2.5A	NEMA 5-15P	12.4 lbs (5.6 kgs)

ITEM	DESCRIPTION	UOM	CASE
ESW-66	Black Kettle Soup Warmer Set	Set	1
ESW-66-I	Black Kettle Soup Warmer Set, International	Set	1
ESW-INS	S/S Insert Pot for ESW-66	Each	2
INSH-7	Hinged Cover for ESW-INS	Each	6/24
ESW66-P38	Replacement Knob	Each	1



ESW-SERIES



ESW-INS



INSH-7

Extra large ladle slot

ELECTRIC WATER PAN



EWP-2



Holds full-size steam table pan. Use as freestanding unit or fits inside standard full-size chafers.

ELECTRIC WATER PAN

Add ease and convenience with this versatile, energy efficient 120 Volt alternative to chafing fuels. It fits most full-size chafers or use as a freestanding unit.

- ◆ Stands alone or fits standard full-size chafers for an electric alternative (food pan sold separately)
- ◆ Accommodates full-size steam table pans
- ◆ Adjustable controls keep contents at safe serving temp
- ◆ Powerful, efficient 900W heating element heats up fast

OVERALL DIMENSIONS L" x D" x H" (mm)	POWER	PLUG	SHIP WEIGHT
22- ⁵ / ₁₆ x 13- ³ / ₁₆ x 7 (575 x 346 x 178)	120V-60Hz, 900W, 7.5A	NEMA 5-15P	6 lbs (2.72 kgs)

ITEM	DESCRIPTION	UOM	CASE
EWP-2	900W, Full-Size	Each	1

Holds a full-size steam table pan and fits in standard full-size chafers

ELECTRIC 30-CUP RICE COOKER

- ◆ Holds up to 30 cups of uncooked rice or up to 60 cups of cooked rice
- ◆ Removable inner pot seals in moisture
- ◆ Automatic warming up to 2 hours

OVERALL DIMENSIONS L" x D" x H" (mm)	POWER	PLUG	SHIP WEIGHT
19-7/8 x 17-1/2 x 13-3/8 (505 x 445 x 340)	110V~50/60Hz, 1550W, 13A	NEMA 5-15P	18 lbs (8.2 kgs)



ITEM	DESCRIPTION	UOM	CASE
RC-P301	Rice Cooker, 30-Cup	Set	1
RC-P301PN	Inner pot for RC-P301	Each	1

Replaces RC-P300



RC-P301

ELECTRIC 30-CUP RICE COOKER & WARMER WITH HINGED LID

- ◆ Holds up to 30 cups of uncooked rice or up to 60 cups of cooked rice
- ◆ Fingerprint-proof satin finish; heavy-duty stainless steel body
- ◆ Removable non-stick inner pot seals in moisture
- ◆ Energy efficient heat absorption system
- ◆ Automatic warming up to 6 hours

OVERALL DIMENSIONS L" x D" x H" (mm)	POWER	PLUG	SHIP WEIGHT
19 x 15-7/8 x 13-7/8 (483 x 397 x 350)	120V~60Hz, 1550W, 13A	NEMA 5-15P	24 lbs (10.9 kgs)



ITEM	DESCRIPTION	UOM	CASE
RC-S301	Rice Cooker/Warmer, Hinged Lid, 30-Cup	Set	1
RC-S301PN	Inner Pot for RC-S301	Each	1
RCW-P1	Serving Paddle	Each	1
RCS301-P1	Measuring Cup	Each	1
RCS301-P8	Fuse for RC-S301	Each	1

Replaces RC-S300



RC-S301

ELECTRIC 100-CUP RICE WARMER WITH HINGED LID

- ◆ Holds up to 100 cups of cooked rice for warming
- ◆ Fingerprint-proof satin finish; heavy-duty stainless steel body
- ◆ Removable non-stick inner pot seals in moisture
- ◆ Energy efficient heat absorption system
- ◆ Warming up to 12 hours

OVERALL DIMENSIONS L" x D" x H" (mm)	POWER	PLUG	SHIP WEIGHT
19 x 14-7/8 x 17-7/8 (483 x 381 x 378)	120V~60Hz, 103W, 0.8A	NEMA 5-15P	20.7 lbs (9.4 kgs)



ITEM	DESCRIPTION	UOM	CASE
RW-S451	Rice Warmer, Hinged Lid, 100-Cup	Set	1
RW-S451PN	Inner pot for RW-S451	Each	1
RCW-P1	Serving Paddle	Each	1

Replaces RW-S450



RW-S451



PANASONIC ELECTRIC 23-CUP RICE COOKER

- ◆ Holds up to 23 cups of uncooked rice or up to 46 cups of cooked rice
- ◆ Removable Inner pot seals in moisture
- ◆ Warming up to 2 hours

OVERALL DIMENSIONS L" x D" x H" (mm)	POWER	PLUG	SHIP WEIGHT
16-7/8 x 14-7/8 x 11-7/8 (429 x 378 x 302)	120V~60Hz, 1550W, 13A	NEMA 5-15P	15.3 lbs (6.94 kgs)

ITEM	DESCRIPTION	UOM	CASE
SR-42HZP-D	Panasonic Commercial Rice Cooker, 23-Cup	Set	1



SR-42HZP-D



ELECTRIC ROUND FOOD COOKERS/WARMERS

With highly efficient heating distribution, Winco's durable and reliable food warmers & cookers/warmers are workhorses that can endure the harshest kitchen environments.

- ◆ Insulated heating compartment for maximum efficiency
- ◆ No-drip rim keeps serving area clean

Fits 7qt inset pot



With inset pot



FW-7R250



FW-7R-SERIES

ELECTRIC ROUND FOOD WARMERS (WET WELL USE ONLY)

- ◆ 3 settings: Low / Medium / High

ITEM	OVERALL DIMENSIONS L" x D" x H" (mm)	WELL OPENING L" x D" x H" (mm)	POWER	PLUG	SHIP WEIGHT
FW-11R250	12-½ x 12-½ x 9-5/8 (518 x 318 x 245)	10-½ x 10-½ x 6-¼ (267 x 267 x 160)	120V-50/60Hz, 750W	NEMA 5-15P	13.5 lbs (6.1 kgs)
FW-7R250	11 x 11 x 9-½ (280 x 280 x 241)	8-¼ x 8-¼ x 6 (210 x 210 x 153)	120V-50/60Hz, 550W	NEMA 5-15P	9.48 lbs (4.3 kgs)

ITEM	DESCRIPTION	UOM	CASE
FW-11R250	11 Qt Warmer	Set	1
FW-7R250	7 Qt Warmer	Set	1

Fits 11qt inset pot



FW-11R500



FW-11R-SERIES

ELECTRIC ROUND FOOD COOKERS/WARMERS (WET WELL USE ONLY)

- ◆ Heats up to 212°F (100°C)

ITEM	OVERALL DIMENSIONS L" x D" x H" (mm)	WELL OPENING L" x D" x H" (mm)	POWER	PLUG	SHIP WEIGHT
FW-11R500	12-½ x 12-½ x 9-5/8 (518 x 318 x 245)	10-½ x 10-½ x 6-¼ (267 x 267 x 160)	120V-50/60Hz, 1250W	NEMA 5-15P	12.6 lbs (5.7 kgs)
FW-7R500	11 x 11 x 9-½ (280 x 280 x 241)	8-¼ x 8-¼ x 6 (210 x 210 x 153)	120V-50/60Hz, 1050W	NEMA 5-15P	9.1 lbs (4.3 kgs)

ITEM	DESCRIPTION	UOM	CASE
FW-11R500	11 Qt Cooker/Warmer	Set	1
FW-7R500	7 Qt Cooker/Warmer	Set	1



FW11R-ADP

FOOD COOKERS/WARMERS ACCESSORIES

ITEM	DESCRIPTION	UOM	CASE
INS-11.0M	11Qt Inset Pan	Each	6/12
INS-7.0M	7 Qt Inset Pan	Each	6/24
FW11R-ADP	Adaptor Ring	Each	1/6



Adaptor ring quickly converts 11qt food cookers/warmers to fit 7qt inset pan

ELECTRIC 4/3 SIZE FOOD WARMER, 1500W (WET WELL USE ONLY)

This commercial-grade food warmer fits four (4) 1/3-size food pans in the extended 27" long well opening, and allows for other pan configurations. Featuring a heavy-duty stainless steel welded body, the energy efficient design heats quickly.

- ◆ Energy-efficient design for fast heating
- ◆ Heavy-duty stainless steel welded body
- ◆ Reliable temperature control for graduated heat settings
- ◆ Dedicated indicator light to easily monitor heating status

OVERALL DIMENSIONS L" x D" x H" (mm)	WELL OPENING L" x D" x H" (mm)	POWER	PLUG	SHIP WEIGHT
14-5/8 x 29-3/4 x 10-5/8 (370 x 755 x 270)	11-13/16 x 27 x 6-5/16 (300 x 658 x 160)	120V-50/60Hz, 1500W, 12.5A	NEMA 5-15P	29.4 lbs (13.4 kgs)



ITEM	DESCRIPTION	UOM	CASE
FW-L600	4/3 Size Warmer	Set	1
FWS600-P5	Power/Thermostat Knob	Each	1

ELECTRIC 4/3 SIZE FOOD WARMER



(1) FULL SIZE, (1) 1/3 SIZE



(4) 1/3 SIZE PANS

27" long well opening



FW-L600

These commercial-grade units accommodate a full-size food pan and allows for other pan configurations. Featuring a heavy-duty stainless steel welded body, the energy efficient design heats quickly.

- ◆ Energy-efficient design for fast heating
- ◆ Heavy-duty stainless steel welded body
- ◆ Reliable temperature control for graduated heat settings
- ◆ Dedicated indicator light to easily monitor heating status

ELECTRIC FULL-SIZE FOOD COOKERS/WARMERS

ELECTRIC FULL-SIZE FOOD COOKER/WARMER, 1500W (WET WELL USE ONLY)

OVERALL DIMENSIONS L" x D" x H" (mm)	WELL OPENING L" x D" x H" (mm)	POWER	PLUG	SHIP WEIGHT
14-5/8 x 22-1/2 x 10-5/8 (370 x 572 x 270)	12 x 20 x 6 (305 x 508 x 153)	120V-50/60Hz, 1500W, 12.5A	NEMA 5-15P	25 lbs (11.4 kgs)



ITEM	DESCRIPTION	UOM	CASE
FW-S600	Cooker/Warmer	Set	1
FWS600-P5	Power/Thermostat Knob	Each	1



FW-S600

ELECTRIC FULL-SIZE FOOD WARMER, 1200W (WET WELL USE ONLY)

OVERALL DIMENSIONS L" x D" x H" (mm)	WELL OPENING L" x D" x H" (mm)	POWER	PLUG	SHIP WEIGHT
14-5/8 x 22-1/2 x 9-3/8 (370 x 572 x 238)	12 x 20 x 6 (305 x 508 x 153)	120V-50/60Hz, 1200W, 10A	NEMA 5-15P	23.2 lbs (10.52 kgs)



ITEM	DESCRIPTION	UOM	CASE
FW-S500	Warmer	Set	1
FWS500-P11	Power/Thermostat Knob	Each	1



FW-S500





FOOD WARMERS



Adaptor plate included



STAINLESS STEEL ELECTRIC FOOD WARMER

This warmer accepts most popular warmer pans, adaptors and lids. The adjustable thermostat allows for virtually any type of cooking or holding condition.

- ◆ Mirror finish 18/8 stainless steel body
- ◆ Precise control adjustable thermostat
- ◆ Includes two-hole adaptor plate for 7Qt inserts
- ◆ Accepts all standard pans, adaptors and lids
- ◆ Water-resistant covered power switch
- ◆ 3-1/2" adjustable legs

OVERALL DIMENSIONS L" x D" x H" (mm)	POWER	PLUG	SHIP WEIGHT
13-1/4 x 21-1/2 x 12-1/2 (336 x 546 x 318)	120V-60Hz, 1200W, 10A	NEMA 5-15P	22 lbs (10 kgs)
WELL OPENING L" x D" x H" (mm)			
12 x 20 x 6-1/4 (305 x 508 x 159)			

ITEM	DESCRIPTION	UOM	CASE
51096	1200W Warmer	Set	1

DUAL-WELL ELECTRIC FOOD WARMERS (PLAIN SIDES, NO GRAPHIC)



51072P

5107XP-SERIES

ITEM	OVERALL DIMENSIONS L" x D" x H" (mm)	POWER	PLUG	SHIP WEIGHT
51072P	21-1/2 x 13-1/4 x 17 (546 x 336 x 432)*	120V-60Hz, 1200W, 10A	NEMA 5-15P	27 lbs (12.3 kgs)
51073P				28 lbs (12.7 kgs)
51074P				30 lbs (13.6 kgs)

*Pump models 20" (508mm) height

ITEM	DESCRIPTION	UOM	CASE
51072P	Warmer with 2 Ladles/Lids	Set	1
51073P	Warmer with 1 Pump & 1 Ladle/Lid	Set	1
51074P	Warmer with 2 Pumps	Set	1

FOOD WARMER ACCESSORIES

ITEM	DESCRIPTION	UOM	CASE
SPHP4	Half-Size Perforated Steam Pan, 4", 25 Ga S/S	Each	6/24
SPJM-204	Half-Size Anti-Jam Steam Pan, 4", 24 Ga S/S	Each	6/24
SPSCH	Half-Size Steam Pan Cover, Solid	Each	12/48
C-DCH	Half-Size Dome Cover, S/S	Each	24
LDI-3	3 oz Ladle, S/S	Each	12/120
ADP-808	Adaptor Plate w/ Two Holes (7qt), S/S	Each	10
INS-7.0M	7 Qt Inset Pan, S/S	Each	6/24
INSH-7	Hinged Inset Cover, S/S	Each	6/24
56752	Condiment Pump for 7 Quart Inset Pan, S/S	Each	1/10



INS-7.0M



INSH-7



56752

Themed Electric Food Warmers

Themed warmers offer style and flexibility with attractive graphics for point-of-sale merchandising, and multiple insert configurations to meet operational needs.



THEMED FOOD WARMERS

"CHICKEN WINGS" WARMER

- ◆ 2 half size pans, 2 domed lids, tongs and tongs holder

OVERALL DIMENSIONS L" x D" x H" (mm)	POWER	PLUG	SHIP WEIGHT
21-½ x 13-¼ x 16 (546 x 336 x 406)	120V-60Hz, 1200W, 10A	NEMA 5-15P	27 lbs (12.3 kgs)

ITEM	DESCRIPTION	UOM	CASE
51072W	Chicken Wings Warmer	Set	1



51072W

"CHILI & CHEESE" WARMER

ITEM	OVERALL DIMENSIONS L" x D" x H" (mm)	POWER	PLUG	SHIP WEIGHT
51072A	21-½ x 13-¼ x 17 (546 x 336 x 432)*	120V-60Hz, 1200W, 10A	NEMA 5-15P	27 lbs (12.3 kgs)
51073A				28 lbs (12.7 kgs)
51074A				30 lbs (13.6 kgs)

*Pump models 20" (508mm) height

ITEM	DESCRIPTION	UOM	CASE
51072A	Warmer with 2 Ladles/Lids	Set	1
51073A	Warmer with 1 Pump & 1 Ladle/Lid	Set	1
51074A	Warmer with 2 Pumps	Set	1



51074A

"HOT FUDGE & CARAMEL" WARMER

ITEM	OVERALL DIMENSIONS L" x D" x H" (mm)	POWER	PLUG	SHIP WEIGHT
51072H	21-½ x 13-¼ x 17 (546 x 336 x 432)*	120V-60Hz, 1200W, 10A	NEMA 5-15P	27 lbs (12.3 kgs)
51073H				28 lbs (12.7 kgs)
51074H				30 lbs (13.6 kgs)

*Pump models 20" (508mm) height

ITEM	DESCRIPTION	UOM	CASE
51072H	Warmer with 2 Ladles/Lids	Set	1
51073H	Warmer with 1 Pump & 1 Ladle/Lid	Set	1
51074H	Warmer with 2 Pumps	Set	1



51073H

"DELICIOUS SOUPS" WARMER

OVERALL DIMENSIONS L" x D" x H" (mm)	POWER	PLUG	SHIP WEIGHT
21-½ x 13-¼ x 17 (546 x 336 x 432)	120V-60Hz, 1200W, 10A	NEMA 5-15P	27 lbs (12.3 kgs)

ITEM	DESCRIPTION	UOM	CASE
51072S	Soup Station, 2 Ladles & Lids	Set	1



51072S



STRIP HEATERS



ESH-36
Shown with undermount bracket and hanging chain

Includes hanging brackets & chains



Built-in plug



Heating element



Indicator light and toggle switch



Designed with a tubular sheath heating element, these premium quality electric strip heaters provide constant, even, and reliable infrared heating. Undermount and freestanding options available.

- ◆ Heavy-duty one piece extruded aluminum body for durability and cleanliness
- ◆ Aluminum heat reflectors with focused heat pattern to maximize holding times
- ◆ On/off toggle switch and 180° full view indicator light for easy operation

UNDERMOUNT ELECTRIC STRIP HEATERS

- ◆ Ideal for pass-through stations or under shelf installations
- ◆ Each unit includes undermount bracket set w/screws and hanging chains

ITEM	OVERALL DIMENSIONS L" X D" X H" (mm)	POWER	PLUG & CORD	SHIP WEIGHT
ESH-24	24 x 6 x 2-7/16 (610 x 153 x 67)	120V-50/60Hz, 500W, 4.2A	NEMA 5-15P 70" (178cm) long cord	11 lbs (5 kgs)
ESH-36	36 x 6 x 2-7/16 (915x 153 x 67)	120V-50/60Hz, 750W, 6.3A		15.4 lbs (7 kgs)
ESH-48	48 x 6 x 2-7/16 (1220x 153 x 67)	120V-50/60Hz, 1000W, 8.3A		17.6 lbs (8 kgs)
ESH-60	60 x 6 x 2-7/16 (1524x 153 x 67)	120V-50/60Hz, 1400W, 12A		22 lbs (10 kgs)
ESH-72	72 x 6 x 2-7/16 (1829x 153 x 67)	120V-50/60Hz, 1800W, 15A		24.3 lbs (11 kgs)

ITEM	DESCRIPTION	UOM	CASE
ESH-24	24"L	Set	1
ESH-36	36"L	Set	1
ESH-48	48"L	Set	1
ESH-60	60"L	Set	1
ESH-72	72"L	Set	1

FREESTANDING ELECTRIC STRIP HEATER

- ◆ Heavy-duty steel stand with powder-coated painted exterior and rust resistant interior coating
- ◆ Stand adjusts to three heights above work surface to control heat intensity



ESH-1-HB

ITEM	OVERALL DIMENSIONS L" X D" (mm)	ADJUSTABLE HEIGHT" (mm)	POWER	PLUG & CORD	SHIP WEIGHT
ESH-1	26-1/8 x 14-1/4 (664 x 362)	18 (457mm)	120V-50/60Hz, 500W, 4.2A	NEMA 5-15P 70" (178cm) long cord	6.61 lbs (3 kgs)
		20-3/8 (524mm)			
		22-7/8 (581mm)			
	STRIP HEATER ONLY L" X D" X H" (mm)				
	24-1/8 x 6 x 2-7/16 (616 x 153 x 67)				

ITEM	DESCRIPTION	UOM	CASE
ESH-1	Electric Strip Heater, Steel	Set	1
ESH-1-HB	Hanging Bracket for ESH-1	Each	1



UNIVERSAL DUMP STATION PAN HOLDERS

UNIVERSAL DUMP STATION PAN HOLDERS

- ◆ Utilize with heat lamps for cohesive presentation
- ◆ Accommodates 2-1/2" and 4" deep pans

ITEM	DESCRIPTION	UOM	CASE
EHL-PH-B	Black, Fits EHL-3C	Each	1/6
EHL-PH-G	Gray, Fits ESH-1, EHL-2 & EHL-2C	Each	1/6



EHL-PH-B



EHL-PH-G

Compatible with Winco heat lamps



HEAT LAMPS

Maintain ideal serving temperatures to keep prepared food warm and appetizing under these infrared, twin-bulb heat lamps, featuring maximum adjustability, improved countertop stability and an easy-to-clean, scratch-resistant finish.

- ◆ Compatible with most standard-size food trays
- ◆ Heavy-duty frame with 13 gauge aluminum bulb hoods and frame
- ◆ Two (2) clear, infrared shatter-resistant 250W/120V bulbs included



EHL-3C



EHL-2C

3-POSITION ELECTRIC STEEL TUBING HEAT LAMPS

- ◆ Easy-clean, durable, scratch-resistant electrostatic powder-coated finished hoods and frame
- ◆ 3-position adjustable height to control heat intensity

OVERALL DIMENSIONS L" X D" (mm)	ADJUSTABLE HEIGHT* (mm)	POWER	PLUG & CORD	SHIP WEIGHT
19-1/2 x 22-1/2 (495 x 571)	23-5/8 (600mm) 26-1/8 (664mm) 28-5/8 (727mm)	120V-50/60Hz, 500W, 4.2A	NEMA 5-15P 70" (178cm) long cord	6.6 lbs (3 kgs)
BASE DIMENSIONS L" X D" (mm)				
18 x 14 (457 x 356)				

ITEM	DESCRIPTION	UOM	CASE
EHL-3C	3-Position Heat Lamp, Black	Set	1
EHL-2C	3-Position Heat Lamp, Gray	Set	1

Heat lamps include 2 clear, infrared shatter-resistant 250W/120V bulbs

4-POSITION ELECTRIC ALUMINUM TUBING HEAT LAMP

- ◆ 14 gauge heavy-duty aluminum tubing frame
- ◆ Easy-clean brushed aluminum finish
- ◆ 4-position adjustable height to control heat intensity

OVERALL DIMENSIONS L" X D" (mm)	ADJUSTABLE HEIGHT* (mm)	POWER	PLUG & CORD	SHIP WEIGHT
19-1/2 x 22-1/2 (495 x 571)	29-3/8 (746mm) 27-1/2 (699mm) 25-1/2 (648mm) 23-3/4 (603mm)	120V-50/60Hz, 500W, 4.2A	NEMA 5-15P 70" (178cm) long cord	7.5 lbs (3.45 kgs)
BASE DIMENSIONS L" X D" (mm)				
16-1/4 x 14-1/4 (413 x 362)				

ITEM	DESCRIPTION	UOM	CASE
EHL-2	4-Position Heat Lamp, Aluminum	Set	1



EHL-2

INFRARED SHATTER-RESISTANT BULBS FOR HEAT LAMPS INFRARED R40 BULBS

- ◆ Shatter-resistant infrared 250W/120V bulbs
- ◆ R40 bulb with medium E26 base
- ◆ Up to 6,000 hours burn time
- ◆ For commercial food-operations only

ITEM	DESCRIPTION	UOM	CASE
EHL-BR	Red	Each	1/12
EHL-BW	Clear	Each	1/12



Retail Box Design



EHL-BW



EHL-BR



winco
SPECTRUM
 COUNTERTOP INDUCTION COOKERS



EICS-SERIES

Compatible with induction-ready cookware

EICS-18
 For U.S. only

EICS-18C
EICS-34
 For U.S. and Canada

COUNTERTOP ELECTRIC INDUCTION COOKERS

Safer than traditional gas or electric resistance burners, induction cooktops use magnetism to rapidly heat up induction cookware, which in turn heats up food. The ideal choice for tableside, catering and buffet-line cooking, induction cooktops are faster and more efficient than installed gas stovetops.

- ◆ Stainless steel body construction
- ◆ Compact, easy-to-clean, portable
- ◆ Easy to use digitally controlled wattage and temperature from warming to cooking for optimal cooking efficiency, control and speed
- ◆ High-impact and high-heat resistant 11-13/16" x 11-13/16" (299mm x 299mm) glass-ceramic cooking surface
- ◆ Accommodates pan sizes between 4-1/2" (114 mm) to 10-1/2" (267mm)
- ◆ Small-article and pan detection
- ◆ Timer up to 150 min (2-1/2 hours)
- ◆ Auto safety shut-off

Heat Efficiency Comparison

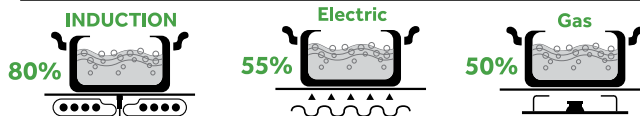

ITEM	OVERALL DIMENSIONS L" X D" X H" (mm)	POWER	PLUG	SHIP WEIGHT
EICS-18	14-3/16 x 18-1/8 x 5-1/8 (360 x 460 x 129)	120V~60Hz, 1800W, 15A	NEMA 5-15P	37.5 lbs (17 kgs)
EICS-18C		120V~60Hz, 1800W, 15A	NEMA 5-20P	
EICS-34		240V~60Hz, 3400W, 14A	NEMA 6-20P	

ITEM	DESCRIPTION	UOM	CASE
EICS-18	US	Set	1/2
EICS-18C	US and Canada	Set	1/2
EICS-34	US and Canada	Set	1/2

ECONOMY INDUCTION COOKER

Low profile



EIC-400E
 For U.S. only

ECONOMY COUNTERTOP ELECTRIC INDUCTION COOKER

- ◆ Up to 1800 watts of continuous heat to cook everything from a low simmer to a rolling boil
- ◆ Easy-touch controls with adjustable power levels (1-10)
- ◆ Ceramic glass surface with small-article and pan detection, 4-3/4"-10-1/4" induction cookware
- ◆ Durable stainless steel and plastic body construction
- ◆ Timer up to 180 min. (3 Hours)

OVERALL DIMENSIONS L" x D" x H" (mm)	POWER	PLUG	SHIP WEIGHT
11-3/4 x 15-3/4 x 2-3/4 (299 x 400 x 70)	120V~60Hz, 1800W, 15A	NEMA 1-15P	13.3 lbs (6 kgs)

ITEM	DESCRIPTION	UOM	CASE
EIC-400E	Induction Cooker	Each	1/4

DROP-IN ELECTRIC INDUCTION COOKERS

Safer than traditional gas or electric resistance burners, induction cooktops use magnetism to rapidly heat up induction cookware, which in turn heats up food. The drop-in induction cookers install directly into the countertop for a built-in, streamlined presentation. Ideal for tableside, catering or buffet-line cooking.

- ◆ Powder-coated steel body construction
- ◆ Compact drop-in-counter design that can be flush, recessed, or mounted with optional trim ring
- ◆ Easy to use digital control with ten (10) power wattage levels from warming to cooking for optimal cooking efficiency, control and speed
- ◆ Remote control panel provided with 36" (915mm) quick-connect cord
- ◆ High-impact and high-heat resistant 11-13/16" x 11-13/16" (299mm x 299mm) glass-ceramic cooking surface
- ◆ Accommodates pan sizes between 4-1/2" (114 mm) to 10-1/2" (267mm)
- ◆ Small-article and pan detection
- ◆ Timer up to 150 min (2-1/2 hours)
- ◆ Auto safety shut-off

ITEM	OVERALL DIMENSIONS L" X D" X H" (mm)	POWER	PLUG	SHIP WEIGHT
EIDS-18	12- ³ / ₁₆ " x 13- ⁷ / ₁₆ " x 3- ⁷ / ₁₆ " (320 x 340 x 98)	120V-60Hz, 1800W, 15A	NEMA 5-15P	27.7 lbs (12.6 kgs)
EIDS-18C		120V-60Hz, 1800W, 15A	NEMA 5-20P	
EIDS-34		240V-60Hz, 3400W, 14A	NEMA 6-20P	

ITEM	DESCRIPTION	UOM	CASE
EIDS-18	US	Set	1/2
EIDS-18C	US and Canada	Set	1/2
EIDS-34	US and Canada	Set	1/2

winco® SPECTRUM™ DROP-IN INDUCTION COOKERS



EIDS-SERIES



Control panel mounts to front of counter where drop-in cooker is installed



Drop-in induction cooker mounted in counter

EIDS-18
For U.S. only

EIDS-18C
EIDS-34
For U.S. and Canada

TRIM RING FOR DROP-IN INDUCTION COOKERS

For a sleek look, install the drop-in induction cookers with this additional trim ring to protect the glass edges and hide the countertop cutout.

ITEM	DESCRIPTION	UOM	CASE
EIDS-TR	Stainless Steel Trim Ring	Each	1



EIDS-TR

PORTABLE BUTANE GAS STOVE

This portable and compact butane gas stove is great for camping, outdoor parties or catered events.

- ◆ Single, top-quality solid brass burner, built-in pot support and wide base for stability
- ◆ Manually adjustable heat range with up to 9,500 BTU of power
- ◆ Comes with a black impact-resistant hard plastic carrying case for easy transport
- ◆ Automatic gas shut-off safety feature
- ◆ Uses standard 8 oz Butane DOT-2P canister (sold separately)

OVERALL DIMENSIONS L" x D" x H" (mm)	POWER	SHIP WEIGHT
13- ³ / ₁₆ " x 10- ³ / ₁₆ " x 4- ¹ / ₄ " (340 x 273 x 108)	9500 BTUs	5.2 lbs (2.4 kgs)

ITEM	DESCRIPTION	UOM	CASE
PGS-1K	Portable Gas Stove w/Case, Black, 9500 BTUs, Brass Burner	Each	1/6

BUTANE GAS STOVE



Superior brass burner



Fits standard Butane canister

PGS-1K

winco
SPECTRUM
IMMERSION CIRCULATORS



ESVI-1800

Refer to Food Storage & Poly Pans for full range of containers



ESVI-1

Get cooking with the Spectrum line of sous vide equipment. With precise temperature control and by reducing heat fluctuations, food retains moisture, nutrition, and flavor for perfect results every time.

- ◆ Precise temperature accuracy: +1°F (0.5°C)
- ◆ Temperature range: 41°F to 210°F (5°-99°C)
- ◆ Timer setting range: 5 minutes to 99 hours
- ◆ LED display: Optional °F / °C, with last temperature and time memory when turned on
- ◆ Maximum volume capacity: 7.9 gallons (30L)

HEAVY-DUTY ELECTRIC IMMERSION CIRCULATOR

- ◆ Stainless steel construction
- ◆ Easy to use solid state digital control panel
- ◆ IPX7 Waterproof up to -1 meter for 30 minutes
- ◆ High wattage for faster heating and recovery
- ◆ Low water level detection and alarm
- ◆ Quick release fastening screw for fast cleaning

OVERALL DIMENSIONS L" X D" X H" (mm)	POWER	PLUG	SHIP WEIGHT
8-7/8 x 7-1/2 x 13 (174 x 112 x 328)	110-120V~60Hz, 1800W, 15A	NEMA 5-15P NEMA 5-20P (Canada)	7.28 lbs 3.3 kgs

ITEM	DESCRIPTION	UOM	CASE
ESVI-1800	Heavy-Duty Immersion Circulator	Each	1

ELECTRIC IMMERSION CIRCULATOR

- ◆ Attached clamp adjusts to fit over container

OVERALL DIMENSIONS L" X D" X H" (mm)	POWER	PLUG	SHIP WEIGHT
3-1/16 x 6-9/16 x 12-7/16 (94 x 167 x 326)	110-120V~60Hz, 900W, 7.5A	NEMA 5-15P	4.4 lbs (2 kgs)

ITEM	DESCRIPTION	UOM	CASE
ESVI-1	Immersion Circulator	Set	1/6

ELECTRIC THERMAL CIRCULATOR

- ◆ Wire clip on side conveniently holds lid when open
- ◆ Built-in faucet and drain for easy water removal
- ◆ Included tray with 8 slots for cooking multiple vacuum-sealed portions
- ◆ Maximum volume capacity: 7.4 gallons (28L)

OVERALL DIMENSIONS L" X D" X H" (mm)	POWER	PLUG	SHIP WEIGHT
22-1/2 x 17-7/16 x 12-3/16 (571 x 442 x 308)	110-120V~60Hz, 1800W, 15A	NEMA 5-15P	18.7 lbs (8.5 kgs)

ITEM	DESCRIPTION	UOM	CASE
ESVC-28	Thermal Circulator	Set	1
ESVC-P17	NEMA 5-20P Cord/Plug (Canada)	Each	1



winco
SPECTRUM
THERMAL CIRCULATOR



ESVC-28



Wire clip holds lid



Sectioned tray

ELECTRIC VACUUM SEALER

- ◆ Compact design with large 3-gallon capacity vacuum chamber
- ◆ Dry vacuum pump and easy-to-use touch controls with adjustable vacuum & seal times, or instant-seal function
- ◆ Stainless steel body construction
- ◆ Heavy-duty transparent lid; dome adds to inner chamber height allowing larger items to fit for sealing

OVERALL DIMENSIONS L" X D" X H" (mm)	CHAMBER DIMENSIONS L" X D" X H" (mm)	POWER	PLUG	SHIP WEIGHT
14-7/8 x 16-3/4 x 15-1/4 (359 x 425 x 388)	12 x 13-7/8 x 5-1/2 (300 x 350 x 133)	110-120- 60Hz, 630W, 5.25A	NEMA 5-15P	59.7 lbs (27.1 kgs)
SEAL BAR 11-1/2" (295mm)	SEAL WIRE 7/64" (3.5mm)			

ITEM	DESCRIPTION	UOM	CASE
EVPM-12	Vacuum Sealer	Set	1
EVPM-P1	Seal Bar Assembly	Each	1

winco® SPECTRUM™ VACUUM SEALER



EVPM-12



11-1/2" seal bar with bag clamp

16" MANUAL IMPULSE BAG SEALER

- ◆ Seals fast, in 0.2 to 3 seconds
- ◆ Compatible with rolled, embossed, flat or zipper vacuum bags with a thickness up to 1/32" (0.5mm)
- ◆ Adjustable timer with indicator light when seal is ready
- ◆ No warm-up time for on-demand sealing
- ◆ Durable aluminum and iron construction

ITEM	OVERALL DIMENSIONS L" X D" X H" (mm)	POWER	PLUG	SHIP WEIGHT
EBS-400M	20-7/8 x 3-5/8 x 12 (530 x 92 x 305)	120V-50/60Hz, 480W, 4A	NEMA 5-15P	15 lbs (6.8 kgs)
EBS-400M-I	SEAL BAR 15-3/4" (400mm)	SEAL WIRE 1/8" (3mm)	220V-50/60Hz, 480W, 2.2A	

ITEM	DESCRIPTION	UOM	CASE
EBS-400M	Impulse Bag Sealer	Set	1/10
EBS-400M-I	Impulse Bag Sealer, International	Set	1/10
EBS-MP10	Seal Wire	Each	1

winco® SPECTRUM™ IMPULSE BAG SEALER



EBS-SERIES

SOUS VIDE ACCESSORIES

ITEM	DESCRIPTION	UOM	CASE
ESV-BH	Multi Ring Bag Stand	Each	1/4
ESV-IB	Insulation Balls, 100-Pcs/Pk	Pack	1/48
EVVPB-0610	Vacuum Sealer Bags, 6" x 8"	Pack	12
EVVPB-0812	Vacuum Sealer Bags, 8" x 12"	Pack	12

winco® SPECTRUM™ SOUS VIDE ACCESSORIES



ESV-IB

ESV-I with ESV-IB insulation balls, to reduce evaporation and hold heat in



Bag stand conveniently holds various sizes of vacuum bags open for easy filling



ESV-BH

RING SIZES
Large: 7" dia
Medium: 5-5/8" dia
Small: 4-3/8" dia

Boil-In VACUUM SEALER BAGS



EVVPB-0812



EVVPB-0610



BELGIAN WAFFLE MAKER

NEW



7" Dia fixed non-stick plates

UP TO
35
WAFFLES PER HOUR

ETL Intertek ETL Intertek
BWM-07

ELECTRIC BELGIAN WAFFLE MAKER

Cook up thick, fluffy waffles with deep divots, perfect for cradling butter, syrup, fruit, and more.

- ◆ Produces up to 35, 1-inch thick waffles per hour
- ◆ Non-stick cooking plates for quick release, easy-to-clean
- ◆ Audible signal alerts when temperature reached, and again when waffle is ready
- ◆ Rotates 180° to evenly distribute batter for perfect waffles every time
- ◆ Space-saving, compact design

OVERALL DIMENSIONS L" x D" x H" (mm)	POWER	PLUG	SHIP WEIGHT
10" x 17-3/4" x 12" (255 x 450 x 305)	120V ~ 50/60Hz, 1000W	NEMA 5-15P	26 lbs (11.8kgs)

ITEM	DESCRIPTION	UOM	CASE
BWM-07	Single Waffle Baker	Each	1

winco SPECTRUM™ COUNTERTOP CONVEYOR TOASTERS



300
OR
700
SLICES
PER HOUR

ETL Intertek ETL Intertek
ECT-SERIES

ELECTRIC CONVEYOR TOASTERS

The ideal choice for serving perfectly toasted breads, bagels, small pizzas, and similar dough-based products. Easy-to-operate, conveyor toasters keep pace with the busiest kitchens and buffets.

- ◆ Heavy-duty all stainless steel "Cool-Touch" exterior
- ◆ Large 2-1/2" high feeder opening with a 10-3/8" (2 slice) wide conveyor accepts over-sized bagels and Texas toast
- ◆ Rounded, extra-wide curved return chute prevents larger foods items from getting caught
- ◆ Variable conveyor-speed dial control for optimal doneness
- ◆ Choose between independent or dual-heating elements for added flexibility
- ◆ Energy Saver hold mode saves up to 75 percent energy during slow periods when unit is not in use and allows quick recovery to temperature
- ◆ Removable crumb tray
- ◆ Adjustable legs with non-skid foot for stability

MODEL	OVERALL DIMENSIONS L" x D" x H" (mm)	POWER	PLUG	SHIP WEIGHT
ECT-300	14-5/8 x 16-7/16 x 16-3/8 (370 x 420 x 415)	120V- 50/60Hz, 1700W, 14.16A	NEMA 5-15P NEMA 5-20P (Canada)	44.5 lbs (20.2 kgs)
ECT-700		208/240V- 50/60Hz, 1800/2400W, 8.6/10A	NEMA 6-15P	

ITEM	DESCRIPTION	UOM	CASE
ECT-300	300 Slices per Hour	Set	1
ECT-700	700 Slices per Hour	Set	1
ECT300-P8	NEMA 5-20P Cord for ECT-300	Each	1

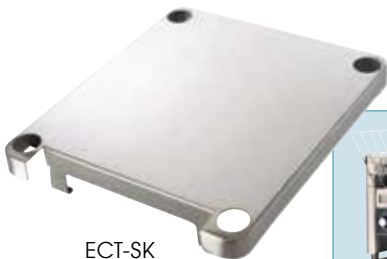

ECT-SK



2 vertically stacked conveyor toaster units



Stacking kit shown on conveyor toaster

STACKING KIT FOR CONVEYOR TOASTERS

- ◆ Save on counter space while maximizing productivity
- ◆ Toast multiple varieties simultaneously
- ◆ Durable stainless steel construction
- ◆ Designed to vertically stack 2 ECT toasters

ITEM	DESCRIPTION	UOM	CASE
ECT-SK	Stacking Kit	Each	1/6

12" or 16" wide tray

New Item

COUNTERTOP CONVECTION OVENS

ELECTRIC COUNTERTOP CONVECTION OVENS

- ◆ Stainless steel construction
- ◆ Heat settings range from 150°F to 500°F (65°C to 260°C)
- ◆ Built-in 120 minute timer with "Stay On" feature
- ◆ Dual pane tempered glass door
- ◆ Spacious interior includes 3 chrome wire shelves
- ◆ Whisper quiet circulation for even heating

ITEM	OVERALL DIMENSIONS L" x D" x H" (mm)	INNER DIMENSIONS L" x D" x H" (mm)	POWER	PLUG	SHIP WEIGHT
ECO-250	18-¾ x 19-7/8 x 15 (477 x 505 x 381)	14 x 11 x 8-½ (356 x 280 x 216)	120V~60Hz, 1440W, 12A	NEMA 5-15P	34.83 lbs (15.8 kgs)
ECO-500	22-½ x 22-¾ x 17-¾ (572 x 579 x 451)	18-½ x 15-½ x 10 (470 x 394 x 254)	120V~60Hz, 1600W, 13.3A		39.68 lbs (18 kgs)

ITEM	DESCRIPTION	UOM	CASE
ECO-250	Quarter-Size, 0.8 Cubic Ft	Set	1
ECO-500	Half-Size, 1.5 Cubic Ft	Set	1
ECO-P5-25	Wire Rack for ECO-250	Each	1
ECO-P5-50	Wire Rack for ECO-500	Each	1
ALXP-1310H	Aluminum 1/4-Size Sheet Pan for ECO-250	Each	24
ALXP-1813H	Aluminum 1/2-Size Sheet Pan for ECO-500	Each	12



ECO-500



MULTI-FUNCTION OVENS (SALAMANDER / BAKER / OVEN)

- ◆ Adjustable thermostat with wide temperature range of 90°F to 550°F
- ◆ Fully insulated stainless steel construction
- ◆ Independent top & bottom heater switches
- ◆ 60 minute timer with "Stay On" feature
- ◆ Adjustable 3" legs
- ◆ Fits 12" pizza (54012), or 16" pizza (54016)

ITEM	OVERALL DIMENSIONS L" X D" X H" (mm)	POWER	PLUG	SHIP WEIGHT
54012	23 x 17 x 11-¼ (584 x 432 x 254)	120V~60Hz, 1750W, 14.6A	NEMA 5-15P	40 lbs (18.1 kgs)
54016	27 x 17 x 11-¼ (686 x 432 x 254)			55 lbs (25 kgs)

ITEM	DESCRIPTION	UOM	CASE
54012	12"x 3" Opening	Set	1
54016	16"x 3" Opening	Set	1

BENCH MARK USA™ MULTI-FUNCTION OVENS



54012
54016

ELECTRIC COUNTERTOP PIZZA OVEN

- ◆ Heats up to 600°F (315°C); dual independently controlled heating elements
- ◆ 60-minute timer with bell includes "Stay On" feature
- ◆ Pizza tray handle folds for storage
- ◆ Includes crumb tray
- ◆ Fits up to 12" diameter pizza

OVERALL DIMENSIONS L" x D" x H" (mm)	POWER	PLUG	SHIP WEIGHT
20-7/8 x 14-¾ x 9-¼ (530 x 375 x 235)	120V~50/60Hz, 1500W, 12.5A	NEMA 5-15P	26.9 lbs (12.2 kgs)

ITEM	DESCRIPTION	UOM	CASE
EPO-1	Pizza Oven w/Bell Timer and "Stay On" Function	Set	1
EPO-P7	Crumb Tray Knob for EPO-1	Each	1

PIZZA OVEN



Fits 12" pizza



EPO-1

winco
SPECTRUM
 STAINLESS STEEL
 MICROWAVES

The Winco commercial microwaves provide consistent results with frequent and repeated use, essential for quick-serve restaurants, concession stands, prep stations, and more. Attractive, fully stainless steel interior and exterior units are reliable, sturdy and easy-to-clean.



ELECTRIC TOUCH CONTROL MICROWAVES - 1800 & 2100 WATTS

- ◆ Stainless steel with glass door and lighted interior provides visibility during operation
- ◆ Large capacity 1.2 cubic feet (34L) accommodates a 14" (356mm) platter
- ◆ 5 power levels for consistent, delicious results
- ◆ Manual time and power option, plus 2X quantity button for multiple portions
- ◆ 10 pre-programmed cooking options, storing up to 100 cooking programs
- ◆ 3-stage cooking with one-touch programming

ITEM	OVERALL DIMENSIONS L" x D" x H" (mm)	POWER	PLUG	SHIP WEIGHT
EMW-1800AT	22-5/8 x 20-3/4 x 14-1/2	208/230V~60Hz, 1800W, 8.6A	NEMA 6-20P	75.6 lbs (34.3 kgs)
EMW-2100BT	(574 x 526 x 368)	208/230V~60Hz, 2100W, 10A		

UL **US**
LISTED
ETL
Intertek
 EMW-1800AT
 EMW-2100BT

ITEM	DESCRIPTION	UOM	CASE
EMW-1800AT	1800 W	Set	1
EMW-2100BT	2100 W	Set	1

ELECTRIC MICROWAVES - 1000 WATTS

- ◆ 1,000 watts of cooking power for quick heating
- ◆ Motor driven bottom antenna for efficient energy distribution and consistent results
- ◆ Engineered for commercial kitchen use
- ◆ Stainless steel interior with bottom ceramic plate
- ◆ Ample 0.9 cubic feet (25 L) oven capacity
- ◆ Accommodates 12" (30.5 cm) diameter platter
- ◆ Backlit LED display
- ◆ Interior oven light



ELECTRIC TOUCH CONTROL MICROWAVE

- ◆ 3 customizable key-beep volumes

OVERALL DIMENSIONS L" x D" x H" (mm)	POWER	PLUG	SHIP WEIGHT
20 1/8 x 17 x 12 1/4 (511 x 432 x 311)	120V~60Hz, 1000W, 12A	NEMA 5-15P	35.7 lbs (16.2 kgs)

UL **US**
LISTED
ETL
Intertek
 EMW-1000ST

ITEM	DESCRIPTION	UOM	CASE
EMW-1000ST	Spectrum Commercial Microwave, Touch, Stainless Steel, 1,000 W	Set	1



ELECTRIC DIAL CONTROL MICROWAVE

OVERALL DIMENSIONS L" x D" x H" (mm)	POWER	PLUG	SHIP WEIGHT
20-1/2 x 18 x 12-5/16 (521 x 457 x 313)	120V~60Hz, 1000W, 12A	NEMA 5-15P	44.1 lbs (20 kgs)

UL **US**
LISTED
ETL
Intertek
 EMW-1000SD

ITEM	DESCRIPTION	UOM	CASE
EMW-1000SD	Spectrum Commercial Microwave, Dial, Stainless Steel, 1,000 W	Set	1

New Item

ELECTRIC COUNTERTOP DEEP FRYERS

Countertop fryers are a great, easy addition to any food service operation. Great for chicken, fries, onion rings, tempura, shrimp, vegetables and more!

- ◆ Commercial fry basket(s) with safe and secure handle
- ◆ Expedient heat-up
- ◆ Removable stainless steel fry well(s) for easy cleaning; fry well cover(s) included
- ◆ Removable power head(s)

COUNTERTOP DEEP FRYERS



EFS-16

ELECTRIC COUNTERTOP SINGLE WELL DEEP FRYER

- ◆ 16 lb oil capacity
- ◆ 8 liters = 16 lbs = 2.11 gallons

OVERALL DIMENSIONS L" X D" X H" (mm)	POWER	PLUG	SHIP WEIGHT
11-3/4 x 16 x 13-5/8 (298 x 406 x 346)	120V-50/60Hz, 1750W, 14.6A	NEMA 5-15P	19.9 lbs (9.03 kgs)

ITEM	DESCRIPTION	UOM	CASE
EFS-16	Single Well Fryer	Set	1
EFST-P30	Fry Basket	Each	1

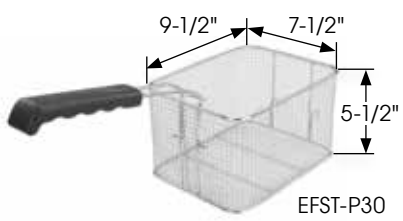

EFST-P30

ELECTRIC COUNTERTOP TWIN WELL DEEP FRYER

- ◆ 32 lb oil capacity
- ◆ 2 x 8 liters (16 liters combined) = 32 lbs; total = 4.22 gallons

OVERALL DIMENSIONS L" X D" X H" (mm)	POWER	PLUG	SHIP WEIGHT
21-1/4 x 16 x 13-5/8 (616 x 406 x 346)	120V-50/60Hz, 1750W, 14.6A (x2)	NEMA 5-15P (x2)	34.8 lbs (15.8 kgs)

ITEM	DESCRIPTION	UOM	CASE
EFT-32	Double Well Fryer	Set	1
EFST-P30	Fry Basket	Each	1



EFT-32

Refer to Kitchen Utensils for fryer accessories



COUNTERTOP SANDWICH GRILLS

Textured grip handle



ESG-1

ELECTRIC COUNTERTOP SANDWICH GRILLS

Flat-top grills are great for sandwiches, and widely used for breakfast eggs and meats, flat breads, quesadillas, and more.

- ◆ Stainless steel construction; flat cast iron grill surface
- ◆ Hinged balanced top plate adjusts to food thickness
- ◆ Removable crumb and grease tray
- ◆ Power and ready light(s)
- ◆ Includes steel-bristle brush w/wooden handle for cleaning
- ◆ Adjustable thermostat up to 600°F (315°C)

ELECTRIC SINGLE FLAT SANDWICH GRILL

OVERALL DIMENSIONS L" X D" X H" (mm)	POWER	PLUG	SHIP WEIGHT
17 x 12 x 8 (432 x 305 x 203)	120V-50/60Hz, 1750W, 15A	NEMA 5-15P	46.6 lbs (21.2) kgs)
GRILL SURFACE L" x D" (mm)			
14 x 9 (356 x 229)			

ITEM	DESCRIPTION	UOM	CASE
ESG-1	Single Grill	Set	1
EPSP-P52S	Handle for ESG-1	Each	1
EPSP-P28	Black Knob w/Red Ring	Each	1
EPSP-P53S	Grease Tray for ESG-1	Each	1
EPSP-P56	Steel Bristle Brush w/Wooden Handle	Each	1

Sturdy hinge



Smooth grilling surface



Easy to use controls



ESG-2

ELECTRIC DOUBLE FLAT SANDWICH GRILL

OVERALL DIMENSIONS L" X D" X H" (mm)		POWER	PLUG	SHIP WEIGHT
22-1/2 x 12 x 8 (572 x 305 x 203)		120V-50/60Hz, 1750W, 15A (x2)	NEMA 5-15P (x2)	57 lbs (25.9) kgs)
GRILL SURFACE L" x D" (mm)	GRILL PLATES L" x D" (mm)			
19 x 9 (483 x 229)	9 x 9 (229 x 229)			

ITEM	DESCRIPTION	UOM	CASE
ESG-2	Double Grill	Set	1
EPSP-P52D	Handle for ESG-2	Each	1
EPSP-P28	Black Knob w/Red Ring	Each	1
EPSP-P53D	Grease Tray for ESG-2	Each	1
EPSP-P56	Steel Bristle Brush w/Wooden Handle	Each	1

ELECTRIC COUNTERTOP PANINI GRILLS

This ribbed grill offers versatility and can be used in many types of food service operations, from paninis and wraps, to grilled vegetables or chicken.

- ◆ Stainless steel construction; ribbed cast iron grill surface
- ◆ Hinged balanced top plate adjusts to food thickness
- ◆ Removable crumb and grease tray
- ◆ Power and ready light(s)

COUNTERTOP PANINI GRILLS



ELECTRIC SINGLE PANINI GRILL

- ◆ Includes steel-bristle brush w/plastic handle for cleaning
- ◆ Adjustable temperature up to 570°F (298°C)

OVERALL DIMENSIONS L" X D" X H" (mm)	POWER	PLUG	SHIP WEIGHT
16-1/8 x 14-3/4 x 9-3/4 (410 x 375 x 248)	120V-50/60Hz, 1750W, 14.6A	NEMA 5-15P	63.3 lbs (28.7 kgs)
GRILL SURFACE L" x D" (mm) 14 x 12 (356 x 305)			

ITEM	DESCRIPTION	UOM	CASE
EPG-1C	Single Grill	Set	1
EPG-CP8	Steel Brush for EPG-1C	Each	1
EPG-CP3	Grease Tray for EPG-1C	Each	1

CAST IRON FLAT-TOP GRIDDLE ADAPTOR PLATE

- ◆ Size: 14-3/8" (365mm) x 11-7/8" (302mm)
- ◆ Pre-seasoned heavy-duty cast iron construction
- ◆ 1/4" raised edges collect, contain and direct grease to front trough
- ◆ Ribbed underside nests tightly with panini plate for efficient high-heat transfer

ITEM	DESCRIPTION	UOM	CASE
EPG-RF1C	Cast Iron Flat Top Griddle Plate for EPG-1C	Each	1

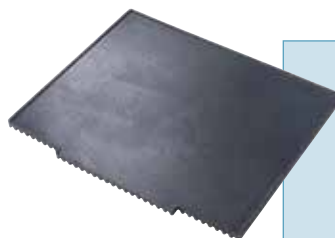

EPG-RF1C

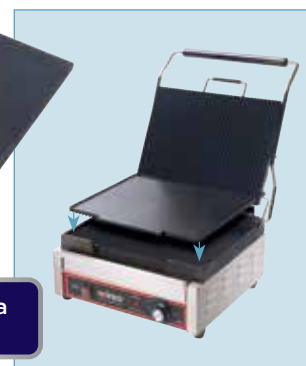

Convert EPG-1C to a flat-top griddle

ELECTRIC DOUBLE RIBBED PANINI GRILL

- ◆ Includes steel-bristle brush w/wooden handle for cleaning
- ◆ Adjustable thermostat up to 600°F (315°C)

OVERALL DIMENSIONS L" X D" X H" (mm)	POWER	PLUG	SHIP WEIGHT	
22-1/2 x 12 x 8 (572 X 305 X 203)	120V-50/60Hz, 1750W, 15A (x2)	NEMA 5-15P (x2)	64 lbs (29 kgs)	
GRILL SURFACE L" x D" (mm)				GRILL PLATES L" x D" (mm)
19 x 9 (483 x 229)				9 x 9 (229 x 229)

ITEM	DESCRIPTION	UOM	CASE
EPG-2	Double Grill	Set	1
EPG-P52D	Handle for EPG-2	Each	1
EPG-P28	Black Knob w/Red Ring	Each	1
EPG-P53D	Grease Tray for EPG-2	Each	1
EPG-P56	Steel Bristle Brush w/Plastic Handle	Each	1



Ribbed grilling surfaces



winco
SPECTRUM
 PLANETARY MIXERS



EMP-10



EMP-20



EMP-30



ELECTRIC PLANETARY MIXERS

Commercial countertop and floor planetary mixers feature gear-driven motors with three speeds, making it an ideal piece of equipment for bakeries, delis, cafés, and other commercial kitchen environments.

- ◆ Heavy-duty die cast iron construction
- ◆ Gear-driven, high torque transmission
- ◆ Large capacity 304 stainless steel bowl with safety guard and interlock bowl lift
- ◆ (3) three fixed mixing speeds
- ◆ Manual resettable thermal overload protection
- ◆ Industry standard #12 attachment hub (EMP-20 & EMP-30)
- ◆ Wire whip, aluminum flat beater, & spiral dough hook attachments included
- ◆ Non-slip rubber feet

ITEM	OVERALL DIMENSIONS L" X D" X H" (mm)	POWER	PLUG	SHIP WEIGHT
EMP-10	15 ^{-1/8} x 18 x 24 ^{-1/8} (383 x 456 x 612)	110V 50/60 Hz 750W 1HP 7A	NEMA 5-15P	99.2 lbs (45 kgs)
EMP-20	19 ^{-7/8} x 21 ^{-11/16} x 29 ^{-3/4} (505 x 550 x 735)	110V 50/60 Hz 1100W 1.5HP 10A	NEMA 5-15P	188.5 lbs (85.5 kgs)
EMP-30	23 ^{-13/16} x 24 ^{-1/2} x 44 ^{-13/16} (605 x 620 x 1138)	110V 50/60 Hz 1500W 2HP 14A	NEMA 5-15P	345.1 lbs (156.5 kgs)

ITEM	DESCRIPTION	UOM	CASE
EMP-10	10.5 Qt (10L)	Set	1
EMP-20	21.1 Qt (20L)	Set	1
EMP-30	31.7 Qt (30L)	Set	1

See spec sheet for replacement bowls, wire whips, flat beaters, hooks, and ingredient chutes

STAINLESS STEEL MIXER STAND WITH MARINE EDGE

The right mix of durability, functionality, and hygiene to provide a reliable and efficient platform for mixing tasks in commercial kitchens.

- ◆ Top shelf: 16-gauge stainless steel, 900lb capacity
- ◆ Marine top-edge contains spills
- ◆ Bottom shelf: galvanized steel, 700lb capacity
- ◆ Sturdy legs with adjustable non-skid feet
- ◆ Stable support for a heavy mixer with no wobble when operating equipment
- ◆ Optimize space and free up valuable countertops
- ◆ Durable & corrosion-resistant to withstand busy kitchens

ITEM	DESCRIPTION	UOM	CASE
EMT-2424	24"L x 24"W x 24"H	Each	1

AVAILABLE
SEPT. 2024

NEW



Marine top-edge contains spills



EMT-2424

ELECTRIC GRIDDLES

Spectrum griddles have a wide heating range, from frying eggs on low to cooking burgers with high heat, all on the half-inch thick polished steel grill surface. Independent controls further regulate the heating zones. The extra-tall steel wall backsplash enclosure helps to minimize grease splatters.

- ◆ Solid 1/2" thick polished steel plate for fast heat up and high heat retention
- ◆ Heavy gauge stainless steel body with 3" high backsplash; sides taper back to front
- ◆ Large-volume removable grease drawer with weep hole and baffle
- ◆ Heavy duty, stainless steel adjustable legs for stability
- ◆ Compatible for 1-phase or 3-phase operation (field convertible EGD-24M & EGD-36M)
- ◆ 3-1/4" full width grease trough

ITEM	OVERALL DIMENSIONS L" X D" X H" (mm)	POWER	PLUG	SHIP WEIGHT
EGD-16M*	16 x 19-1/8 x 12-7/8 (406 x 486 x 327)	120V 50/60 Hz 1750W 14.6A	NEMA 5-15P NEMA 5-20P (Canada)	53 lbs (24 kgs)
EGD-24M**	24 x 21-3/4 x 12-7/8 (610 x 551 x 327)	208/240V- 50/60 Hz, 4200/5600W, 20.2/23.4A, 1-phase	NEMA L6-30P	116.84 lbs (53 kg)
EGD-36M**	36 x 21-3/4 x 12-7/8 (913 x 551 x 327)	208/240V- 50/60 Hz, 6300/8400W, 30.29/35A, 1-phase	Field-wired by others	159.61 lbs (72.4 kg)

*Cooking surface depth 15-1/8"(384mm) **Cooking surface depth 16-1/2"(419mm)

ITEM	DESCRIPTION	UOM	CASE
EGD-16M	16" Griddle, 1 Heat Zone	Set	1
EGD-24M	24" Griddle, 2 Heat Zones	Set	1
EGD-36M	36" Griddle, 3 Heat Zones	Set	1
EGD-MP6	Replacement Knob	Each	1
EGD-MP19	NEMA 5-20P cord for EGD-16M	Each	1

winco
SPECTRUM
COUNTERTOP ELECTRIC GRIDDLES

Small footprint, big impact

EGD-16M



EGD-24M



EGD-36M



Adjustable legs



GAS STOCK POT STOVE, FLOOR USE

Designed for the kitchen that has limited space and requires a low work height for large pots. This unit is equipped with a high-performance triple-ring burner, heavy duty single-piece cast iron top grate, removable crumb tray and a storage area below the control panel. Includes an LP conversion kit.

- ◆ High performance single (1) grate with three (3) concentric ring burners for a total output of 80,000 BTUH
- ◆ Dual infinite heat controls
- ◆ Stainless steel body, legs and drip pan
- ◆ Heavy duty cast iron grate
- ◆ Standing pilot ignition system with stainless steel pilots and pilot tubes
- ◆ 3/4" rear gas connection with regulator
- ◆ Convenient storage area in cabinet
- ◆ Conversion kit allows the use of propane or natural gas

ITEM	DESCRIPTION	UOM	CASE
NGSP-1	18" Gas Stock Pot Stove	Set	1
NG-Knob	Replacement Metal Knob	Each	1

winco
SPECTRUM
GAS STOCK POT STOVE

2 infinite heat controls



For use on the floor

# OF BURNERS	# OF RINGS	BTU/PER NAT/LP	TOTAL BTU/HR	PRESSURE IN. W.C.	DIMENSIONS* L" x D" x H" (mm)	GRATE SURFACE L" x D" (mm)	SHIP WEIGHT
2	3	40,000	80,000	5 / 10	18 x 21-3/8 x 25 1/2 (455 x 543 x 653)	17 1/2 x 21-3/8 (450 x 543)	132 lbs (60 kgs)

Note: Depths do not include gas inlet pipe, located at rear of the unit.



NGSP-1

winco
SPECTRUM
 COUNTERTOP
 GAS CHARBROILERS

GAS CHARBROILERS, NATURAL / LP

The durable Spectrum stainless steel charbroilers feature a cool-touch front plate rail that runs the full length. These units are equipped with infinite heat controls, high-performance burners, heavy-duty cast iron top grates, and removable grease tray(s).



NGCB-24R



NGCB-36R



NGCB-48R

- ◆ High performance burners, each with output of 35,000 BTUH
- ◆ Infinite heat controls
- ◆ Stainless steel 10 gauge radiant burner covers; field-convertible briquette rock kits sold separately
- ◆ Stainless steel insulated double-wall body, grease tray and adjustable legs (4" to 6"); non-skid feet
- ◆ Heavy-duty reversible cast iron grate, adjusts to three (3) height positions
- ◆ 5" cool-touch stainless steel front plate rail provides safety and knob protection
- ◆ 3-1/2" full-width grease trough
- ◆ Standing pilot ignition system with stainless steel pilots and pilot tubes, one per burner
- ◆ 3/4" rear gas connection with regulator
- ◆ Conversion kit allows the use of propane or natural gas

ITEM	DESCRIPTION	UOM	CASE
NGCB-24R	24" Gas Broiler, 2 Burners	Set	1
NGCB-36R	36" Gas Broiler, 3 Burners	Set	1
NGCB-48R	48" Gas Broiler, 4 Burners	Set	1
NG-Knob	Replacement Metal Knob	Each	1



Adjustable legs



NGCB-SERIES

ITEM	# OF BURNERS	TOTAL BTU/HR	PRESSURE IN. W.C.	DIMENSIONS* L" x D" x H" (mm)	GRATE SURFACE L" x D" (mm)	SHIP WEIGHT
NGCB-24R	2	70,000	4" / 10"	24 x 34 ^{-7/16} x 15 ^{-1/2} (610 x 875 x 394)	24 x 20 (610 x 508)	154 lbs (70 kg)
NGCB-36R	3	105,000	4" / 10"	36 x 34 ^{-7/16} x 15 ^{-1/2} (915 x 875 x 394)	36 x 20 (915 x 508)	220 lbs (100 kg)
NGCB-48R	4	140,000	4" / 10"	48 x 34 ^{-7/16} x 15 ^{-1/2} (1220 x 875 x 394)	48 x 20 (1220 x 508)	277 lbs (126 kg)

*includes gas inlet pipe at rear



NGCB-P11-2/3/4



NGCB-P7

GAS CHARBROILER ACCESSORIES - FIELD CONVERTIBLE

ITEM	DESCRIPTION	UOM	CASE
NGCB-P11-2	24" Briquette Rock Kit	Pack	1
NGCB-P11-3	36" Briquette Rock Kit	Pack	1
NGCB-P11-4	48" Briquette Rock Kit	Pack	1
NGCB-P7	Replacement Briquettes (24/bag)	Bag	1

GAS GRIDDLES, NATURAL / LP

Spectrum griddles are designed with durable stainless steel construction and cool-touch front plate rail that runs the full length. These units are equipped with infinite heat controls, high-performance burners, and removable grease drawer.

- ◆ High performance burners, each with output of 30,000 BTUH
- ◆ Infinite heat controls
- ◆ 5" wide cool-touch stainless steel front plate rail provides safety and knob protection
- ◆ Stainless steel insulated double-wall body, grease tray and adjustable legs (4" to 6"); non-skid feet
- ◆ 3/4" polished steel griddle plate with side and back splash guard
- ◆ 3-1/2" full width grease trough
- ◆ Standing pilot ignition system with stainless steel pilots and pilot tubes, one per burner
- ◆ 3/4" rear gas connection with regulator
- ◆ Conversion kit allows the use of propane or natural gas

ITEM	DESCRIPTION	UOM	CASE
NGGD-24M	24" Gas Griddle, 2 Heat Zones	Set	1
NGGD-36M	36" Gas Griddle, 3 Heat Zones	Set	1
NGGD-48M	48" Gas Griddle, 4 Heat Zones	Set	1
NG-Knob	Replacement Metal Knob	Each	1

winco® SPECTRUM™ COUNTERTOP GAS GRIDDLES



NGGD-24M



NGGD-36M



NGGD-48M

ITEM	# OF BURNERS	TOTAL BTU/HR	PRESSURE IN. W.C.	DIMENSIONS* L" x D" x H" (mm)	GRIDDLE SURFACE L" x D" (mm)	SHIP WEIGHT
NGGD-24M	2	60,000	4" / 10"	24" x 34-7/16" x 15-1/2" (610 x 950 x 394)	24" x 20-3/4" (610 x 527)	196 lbs (89 kg)
NGGD-36M	3	90,000		36" x 34-7/16" x 15-1/2" (915 x 950 x 394)	36" x 20-3/4" (915 x 527)	284 lbs (129 kg)
NGGD-48M	4	120,000		48" x 34-7/16" x 15-1/2" (1219 x 950 x 394)	48" x 20-3/4" (1219 x 527)	355 lbs (161 kg)

*includes gas inlet pipe at rear



NGGD-SERIES



Adjustable legs

winco
SPECTRUM
 COUNTERTOP
 GAS HOT PLATES

GAS HOT PLATES, NATURAL / LP

Spectrum hot plates are designed with durable stainless steel construction and a cool-touch front plate rail that runs the full length. These units are equipped with infinite heat controls, high-performance burners, heavy-duty cast iron top grates, and removable grease/drip pan.

- ◆ High performance burners, each with output of 25,000 BTUH
- ◆ Infinite heat controls
- ◆ Stainless steel body, removable drip pan, and adjustable legs (4" to 6"); non-skid feet
- ◆ Heavy-duty 12" x 12" cast iron grates
- ◆ 5" wide cool-touch stainless front steel plate rail provides safety and knob protection
- ◆ Standing pilot ignition system with stainless steel pilots and pilot tubes, one per burner
- ◆ 3/4" rear gas connection with regulator
- ◆ Conversion kit allows the use of propane or natural gas



NGHP-2



NGHP-4



NGHP-6

ITEM	DESCRIPTION	UOM	CASE
NGHP-2	12" Hot Plate, 2 Burners	Set	1
NGHP-4	24" Hot Plate, 4 Burners	Set	1
NGHP-6	36" Hot Plate, 6 Burners	Set	1
NG-Knob	Replacement Metal Knob	Each	1



Adjustable legs



NGHP-SERIES

ITEM	# OF BURNERS	TOTAL BTU/HR	PRESSURE IN. W.C.	DIMENSIONS* L" x D" x H" (mm)	GRATE SURFACE L" x D" (mm)	SHIP WEIGHT
NGHP-2	2	50,000	4" / 10"	12 x 34-1/8 x 15 (305 x 87 x 381)	12 x 24 (305 x 610)	79 lbs (36 kgs)
NGHP-4	4	100,000		24 x 34-1/8 x 15 (610 x 87 x 381)	24 x 24 (610 x 610)	132 lbs (60 kgs)
NGHP-6	6	150,000		36 x 34-1/8 x 15 (915 x 87 x 381)	36 x 24 (915 x 610)	198 lbs (90 kgs)

*includes gas inlet pipe at rear

STAINLESS STEEL MIXER STAND WITH MARINE EDGE

The right mix of durability, functionality, and hygiene to provide a reliable and efficient platform for mixing tasks in commercial kitchens.

- ◆ Top shelf: 16-gauge stainless steel, 900lb capacity
- ◆ Marine top-edge contains spills
- ◆ Bottom shelf: galvanized steel, 700lb capacity
- ◆ Sturdy legs with adjustable non-skid feet
- ◆ Stable support for a heavy mixer with no wobble when operating equipment
- ◆ Optimize space and free up valuable countertops
- ◆ Durable & corrosion-resistant to withstand busy kitchens

ITEM	DESCRIPTION	UOM	CASE
EMT-2424	24"L x 24"W x 24"H	Each	1



EMT-2424

AVAILABLE SEPT. 2024

NEW

NSF

EMT-2424

STAINLESS STEEL EQUIPMENT STANDS

Optimize workflow, ensure safety and hygiene, and maximize the efficiency of commercial kitchens and workspaces.

- ◆ Top shelf: 16-gauge stainless steel, 900lb capacity
- ◆ 1-1/2" high raised edges on 3 sides prevent items from slipping off
- ◆ Bottom shelf: galvanized steel, 700lb capacity
- ◆ Sturdy legs with adjustable non-skid feet
- ◆ Easy-clean smooth surfaces promote hygiene and sanitation, reducing risk of cross-contamination to ensure compliance with health & safety regulations
- ◆ Designed to stand at a comfortable height to reduce strain and fatigue for improved productivity and overall well-being.

ITEM	DESCRIPTION	UOM	CASE
ES-2430	24"L x 30"W x 24"H	Each	1
ES-3630	36"L x 30"W x 24"H	Each	1
ES-4830	48"L x 30"W x 24"H	Each	1
ES-6030	60"L x 30"W x 24"H	Each	1



24"

AVAILABLE SEPT. 2024

NEW

NSF

ES-SERIES

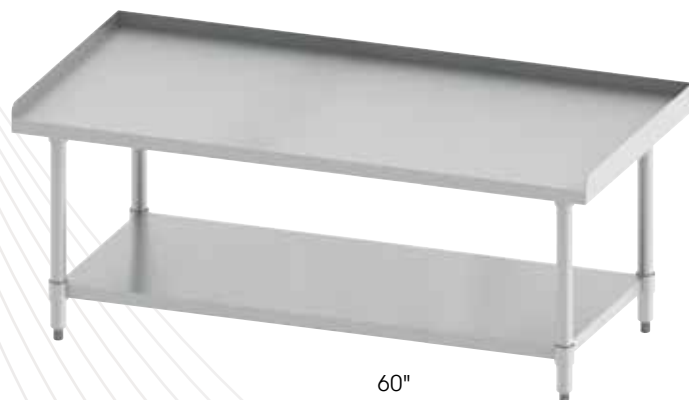

60"



48"

DINNERWARE	14
FLATWARE	34
BUFFET SERVICE	54
TABLETOP	74
DINING SERVICE	91
BEVERAGE SERVICE	120

DISPLAY	130
BAR SUPPLIES	135
APPAREL	169
PRO. CUTLERY	183
PRO. COOKWARE	209
STEAM TABLE PANS	236

POLY PANS/STORAGE	243
BAKEWARE	250
PIZZA SUPPLIES	271
FOOD PREP	282
KITCHEN UTENSILS	297
JANITORIAL	341

SHELVING & RACKS	368
BUSSING/TRANSPORT	374
COUNTERTOP EQUIPMENT	388
MERCHANDISING DISPLAYS	461

Index by ITEM NUMBER
Red indicates NEW item

0-9

0001	49
0002	49
0004	47
0005	43
0006	42
0007	44
0008	45
0010	44
0012	49
0014	49
0015	43, 53
0016	45
0019	46
0021	42
0023	48
0024	47
0025	47
0026	46
0030	34, 42, 53, 71
0031	35
0033	41
0034	39, 53
0035	40
0036	38
0037	37
0039	36
0081, 0082, 0083	50
101, 101A, 101B	54
103, 103A, 103B	54
108A	55
201, 202, 203	59
207, 211	63
308A	55
408	59
508	59
601, 602, 603	54-56
708	59
901, 902	67, 121
903A, 903B	66, 120
904	67, 121, 122
905A, 905B	66, 120
908	66, 120
11040, 11060, 11080	404
11045, 11065	405
11048, 11068	406
11087, 11147	407
21011	427

23210	152
23752, 23772, 23772	152
30010	404
30050	405
30070	414
30080	406
30087	407
30090	412
30147	407
40004, 40006, 40008	410
40010, 40011, 40012	410
40015, 40017	410
40021, 40023	410
40508	410
41001, 41002, 41003	411
4104XCS	411
412XXCS	411
414XXCS	411
415XXCS	411
42030	409
47001	420
51000	420
51012, 51018	421
51026	420
51040, 51048	421
51072X	432-433
51073X	432-433
51074X	432-433
51096	432
52001	419
53021	420
54012, 54016	441
56752	432
60024	418
60048	418
60072	419
62010, 62020, 62030	417
64010, 64020, 64030	417
65010, 65020, 65030	417
67002	419
68001CS, 68002, 68004CS	419
71000	414
71050	414
720XXCS	415
72301	409, 415
72305	415
72401CS	415
72501, 72507	415
72701	415
81011, 81011A	412
82001CS-82006CS	412

83001CS	412
83005, 83007	412
92001	409
92002	419
92003	415
92004	420
92005	413
92006	421

A

A-200, A-205-P	160, 388
AA	161, 389
AAD	333
AASP	254
ABBC	383
ABPN	253
ACN	132
ACP	252, 255
ACS	332
ACSD	104, 145
ACSS	91
ACTD	104
ACVP	98
ADB	132, 239
ADBC	339
ADC	133
ADD	263, 278
ADO	82
ADP	241, 432
ADRG	265, 275
ADRK	372
AES	335
AFD	364
AFP	225, 228, 298
AFPI	224
AGP	230
AHC	339
AICD	308
ALB	227
ALBC	383
ALBH	226
ALBP	229
ALCR	373
ALDP	262, 276
ALHP	226
ALO	287
ALPC	224, 226-227
ALPR	273, 377
ALRC	273, 375-377, 379, 383
ALRK	375, 377, 379
ALRP	229

ALRS	376
ALSB	230
ALSP	231
ALST	227
ALXN	250
ALXP	98, 229, 250, 441
ALZK	376
AM	270, 321
AMF	256-257
AMT	336
AP	123, 284
APCD	264, 288
APL	82
APM	255
APP	274, 338
APPL	255
APRK	123
APS	230
APSK	123
APSP	123
APZC	271
APZK	271
APZS	272
APZT	271-272
ARP	263, 278
AS	330
ASDR	372
ASET	227
ASFB	330
ASFP	230
ASFT	89, 102, 131
ASHP	226
ASP	224, 228
ASS	324
ASSP	227
AST	130
ATC	102
ATCH	93
AWPR	273, 377
AWRC	374, 379
AWRK	374, 375
AWRS	376
AWZK	376
AXPE	251
AXTI	224

B

BA	107-108, 176-177, 179, 354
BABS	136-137
BADN	106, 175
BADP	179, 354

BAJ.....	136-137	BTH.....	167, 357	CEP.....	217	CSPP.....	77, 218
BAJS.....	136-137	BTM.....	167, 357	CF.....	125	CST.....	260
BAM.....	241	BTW.....	167, 357	C-F1.....	54-63	CT.....	374
BAMC.....	241	BW.....	70	C-F2, C-F4, C-F6.....	62	CVBS.....	73, 315
BAMN.....	240, 302	BWM.....	440	CGS.....	116-117	CVLD.....	73, 315
BASK.....	136-137	BXC.....	353	CGSF.....	117	CVPS.....	73, 315
BASS.....	136-137	C		CH.....	180	CVSS.....	73, 315
BAW.....	179, 354	C-1F.....	62	CHB.....	113	CVST.....	73, 315
BC.....	142	C-3F.....	62	CHBC.....	180	CW.....	259, 300
BCH.....	147	C-1080.....	58	C-HDC.....	238	C-WPF.....	56, 58-61, 237
BCS.....	87	C-2080B.....	60	C-HFC1.....	238	C-WPF6.....	237
BFM.....	298	C-3080B.....	60	CHH.....	113	C-WPP.....	237
BGCB.....	281, 385	C-4080.....	61	CHHW.....	180	CXP.....	251
BGDB.....	281, 385	C-5080.....	58	CHK.....	103	D	
BGDV.....	280, 386	CAGP.....	221	CHPB.....	180	DB.....	257
BGPZ.....	280-281, 385-386	CASD.....	221	CJ.....	88	DCCR.....	75
BGS.....	100, 284	CASM.....	74-75	CKCF.....	233	DCFP.....	75
BHKF.....	314	CAST.....	74-75, 221	CKM.....	253	DCH.....	179
BHKP.....	313	CB.....	294	CKS.....	133, 258	DCL.....	75
BHKS.....	313	CBBN.....	295	CKSR.....	258	DCSC.....	75
BHON.....	305	CBBU.....	295	CL.....	105	DCSP.....	75
BHOP.....	314	CBEL.....	103	CLR.....	105	DCWA.....	76
BHPN.....	305	CBF.....	295	CLSO.....	129	DCWB.....	76
BHPP.....	314	CBGR.....	295	CMF.....	257	DCWC.....	76
BHSN.....	305	CBH.....	294	CMM.....	79, 144	DCWD.....	76
BHSP.....	314	CBI.....	294	CMT.....	69, 97	DCWE.....	76
BL.....	138, 158	CBK.....	293	CO.....	146, 147, 334, 396	DDSA.....	79
BLS.....	139	CBM.....	398	COD.....	287	DDSB.....	77
BM.....	158	CBN.....	141, 292, 298	CODS.....	325	DDSC.....	77
BML.....	158	CBPP.....	298	CP.....	51, 394-395	DDSD.....	79
BMP.....	150-151, 155	CBR.....	295, 358	CPSF.....	254	DDSE.....	79, 144
BPS.....	139	CBRD.....	295	CR-102.....	141	DDSF.....	105
BR.....	128, 279, 359-361, 363	CBS.....	155	CR-1240.....	141	DDSG.....	87
BRAF.....	351	CBST.....	295	CR-1262.....	139	DDSH.....	80
BRAU.....	351	CBWT.....	141, 294	CR-1440, -1451B.....	66, 124	DDSI.....	80
BRB.....	294, 358	CBXH.....	294	CR-1600, -1610, -1620.....	145	DET.....	162, 391
BRC.....	358	CBYL.....	295	CR-220P.....	151	DIS.....	162, 391
BRF.....	351	CC.....	260	CR-2400, -2401.....	159	DLR.....	344
BRFC.....	351	CCB.....	325	CR-285.....	151	DM.....	350
BRFF.....	351	CCH.....	142	CR-300UN.....	151	DMB.....	350
BRH.....	351	CCK.....	111	CR-400.....	151	DMM.....	350
BRM.....	112, 351	CCM.....	412-413	CR-700, -701.....	166, 367	DOL.....	165
BRN.....	228, 358, 359	CCM28.....	413	CR-759, -760.....	166, 367	DP.....	112, 352
BRP.....	228, 359	CCOD.....	287	CR-835W, -838W.....	331	DRG.....	265, 275
BRS.....	163, 390	CCP.....	254	CR-840W, -846W, -849W.....	331	DSC.....	262, 277, 298
BRV.....	294, 358	CCS.....	325	CR-850, -854.....	331	DT.....	66, 124
BS.....	126, 138	CD.....	128-129	CR-890W.....	409	DWAB.....	130
BSFK.....	314	CDB.....	128, 359	CR-899.....	262, 277	DWCC.....	95, 157
BSOB.....	314	C-DCF.....	238	CR-925, -926.....	269, 318	DWR.....	249, 276, 342, 379
BSON.....	305	C-DCH.....	238, 432	C-RCF.....	132, 238	E	
BSOT.....	313	CDIC.....	129	CRD.....	424	EBS.....	439
BSPB.....	314	CDP.....	142	CRK.....	131, 248	ECO.....	441
BSPN.....	305	C-DP1, -DP2.....	132, 243	CRKC.....	131, 248	ECT, ECT300.....	440
BSPT.....	313	C-DPF1, -DPF2.....	132, 243	C-RTC.....	58	ECU.....	426
BSSB.....	314	C-DPFH.....	132, 243	CS.....	103, 257, 332	EDM.....	422-423
BSSN.....	305	CDR.....	129	CSF.....	346	EF.....	285, 335
BSST.....	313	CDT.....	259	CSFP.....	218		
BST.....	139	CDTC.....	259	CSP.....	128		
BTGP.....	167, 357						

EFS.....443
 EFST.....443
 EFT.....443
 EGD.....447
 EGR.....338
 EGRS.....338
 EHDG.....416
 EHL.....434-435
 EIC.....64, 436
 EICS.....65, 436
 EIDS.....64, 437
 EMP.....446
 EMT.....446, 451
 EMW.....442
 EPG.....445
 EPO.....441
 EPSG.....444-445
 ES.....451
 ESG.....444
 ESH.....434
 ESV.....439
 ESVC.....438
 ESVI.....438
 ESW, ESW66, ESW70.....428
 EVPB.....439
 EVPM.....439
 EWB.....427
 EWCU.....426, 427
 EWP.....63, 428

F
 FAUCET.....66, 120
 FB.....233-234
 FBM.....78
 FBR.....231
 FBRS.....231
 FB-TS.....166, 367
 FC.....112, 380
 FCS.....284
 FCW.....149, 248, 344
 FDS.....348
 FF.....234, 339
 FFB.....234, 339
 FFBN.....234, 339
 FFC.....402
 FFT.....98, 251
 FLY.....164
 FMC.....341
 FMG.....341
 FN.....316
 FPP.....299, 309
 FPPN.....304
 FPS.....299, 309
 FPSN.....304
 FQP.....255
 FS.....82, 219, 235, 339
 FSC.....348
 FSP.....337

FSS.....348
 FST.....322
 FSW.....112, 352
 FVS.....398
 FW.....430-431
 FW11R.....430
 FWS.....401, 431

G
 G.....84-85
 GBH.....361
 GBK.....361
 GBS.....87
 GCRA.....199
 GH.....159
 GHC.....159
 GHT.....126
 GLC.....111, 178
 GLN.....353
 GLP.....353
 GOB.....84
 GP.....51, 164, 335, 392-393
 GR.....141
 GS.....126
 GSH.....361
 GSN.....361
 GT.....101, 332
 GTP.....126
 GWB.....164, 359
 GWM.....164, 359

H
 HAC.....255, 272
 HAG.....219
 HBP.....397
 HCD.....401
 HDH.....219
 HDM.....423
 HFC.....402
 HFS.....366
 HLF.....252, 257
 HLP.....252
 HMF.....256
 HP.....336
 HPP.....252
 HPR.....69, 130
 HPS.....69, 130
 HRCP.....252
 HSCP.....252
 HSP.....254
 HTS.....116

I
 IB.....247, 383
 ICB.....149
 ICC.....86
 ICCP.....148
 ICCT.....148

ICD.....299, 308
 ICH.....148
 ICOP.....307
 ICP.....149
 ICR.....257
 ICS.....308
 ICT.....72, 148, 311
 IFT.....384
 IGD.....219
 IGL.....221
 IIC.....149, 384
 INS.....241, 430, 432
 INSC.....63, 240-241, 302
 INSH.....63, 241, 428, 432
 INSN.....240, 302
 IS.....148, 330
 ISP.....82, 219
 ISS.....308
 IT.....72, 148, 311

J
 J.....139
 JB29XX.....126
 JC.....140, 285, 333
 JCB.....345
 JST.....139

K
 K-12S, -14S, -34S.....198
 K-35W.....53, 207
 K-40P.....199
 K-438W.....53, 207
 K-45W.....53, 207
 K-50P.....52, 206
 K-54S.....198
 K-55W.....53, 207
 K-60P.....52, 206
 K-70P, -71P.....52, 206
 K-73PC.....53, 207
 K-80P, -81P, -82, -85P.....52-53, 206-207
 KAT.....399-401
 KB.....53, 207
 KBG.....203
 KBP.....203
 KC.....201
 KCC.....204
 KCL.....205, 337
 KCP.....205
 KCS.....101, 205
 KDB.....77
 KFP.....184-187, 198, 201, 338
 KGD.....202
 KH.....199, 259
 KPC.....165
 KPF.....338
 KPP.....204, 274
 KPR.....199

KR.....202
 KS.....200, 334
 KSP.....196-197
 KSTK.....188-189, 204, 274
 KWP.....190-195, 299, 316

L
 LC.....102, 334, 337
 LDC.....299, 309
 LDCN.....303
 LDI.....309, 432
 LDIN.....303
 LDT.....309
 LE.....71
 LED.....118
 LMD.....92
 LMF.....92
 LMS.....92
 LMTD.....92
 LMTT.....92
 LS.....140, 333

M
 MAS.....105, 44
 MB.....119, 134, 333
 MBAF.....119, 134
 MBB.....119, 134
 MBBE.....119, 134
 MBM.....119, 134
 MBPM.....119, 134
 MCP.....138, 270, 321, 409
 MCPP.....270, 320
 MDL.....283
 MG.....397
 MH.....68, 94
 MHH.....352
 MMB.....32-33
 MMPO.....32
 MMPR.....32
 MMPT.....32
 MMSC.....33
 MMU.....33
 MOP.....347
 MOPH.....347
 MOPM.....347
 MOPR.....347
 MPB.....346
 MPD.....269, 277, 318
 MPF.....231, 324
 MPN.....231, 324
 MPS.....141, 284
 MS2K.....139, 265, 327
 MS3A.....327
 MSB.....328
 MSBW.....328
 MSH.....325
 MSK.....110, 169
 MSL.....270, 320

MSP	270, 320	PDT	127	PSD	268, 319	SBD	124
MSPD	270, 320	PECC	244, 298	PSG	268, 319	SBF	253
MSPP	270, 320	PESC	244	PSGE	268, 319	SBM	141
MSS	326	PF	264, 328	PSH	268, 319	SBMW	80
MST	327	PFB	90, 99	PSM	336	SBR	88
MSTF	327	PFBT	154	PSN	86	SBS	251, 298
MSTP	327	PFD	115	PSR	167, 354	SBW	88, 102
MT	336	PFFW	246	PST	263	SC	326
MWP	316	PFFHW	246	PSUD	87, 329	SCAL	282
MXB	286	PFS	110	PSW	100, 329	SCB	112, 380
MXBH	286	PFSF	246	PT	72, 148, 311-312, 419	SCC	333
MXBS	286	PFSH	246	PTC	342, 344	SCD	129
MXBT	286	PGS	437	PTCB	342	SCF	326
MXHV	286	PGW	239, 251	PTCL	342, 344	SCP	86
MXRU	286	PGWS	239, 251	PTCP	342	SCPH	104
		PH	217, 228, 267, 393	PTCR	343	SCRP	361
		PJC	344-345	PTCRL	343	SCS	326
N		PK	99, 144	PTCS	343	SCT	87
NACP	254	PKT	154, 288, 362	PTCSB	343	SCU	255
NB	266	PKTS	86, 100, 288, 419	PTCSL	343	SD	88, 364
NC	317	PL	112, 249, 262, 276, 380-381, 414	PTCSP	343	SDA	337
NG	447-450	PLB	90, 99	PTK	301	SDAF	364
NGCB	448	PLK	333	PTM	316	SDAL	364
NGGD	449	PLP	381	PTMP	316	SDC	258
NGHP	450	PLTC	381	PTOS	72, 312	SDMF	364
NGSP	447	PLW	381	PTP	127	SDML	364
NH	104	PMB	202	PTRC	245	SDP	104, 145
NLG	353	PMC	93	PTS	78	SDT	104
NLGH	353	PMCD	93	PTSC	244	SES	335
NPM	285	PMCD	93	PTSN	127	SF	264, 288, 328
NS	269, 318	PMCF	93	PTW	83	SFC	78
NSP	269, 318	PMCP	270, 321	PUTF	73, 314	SFCR	235, 339
NTHM	254	PMCT	93	PWBK	90	SFCS	235, 339
		PMG	199, 337	PWBN	90, 31	SFCW	78
O		PMP	83	PWC	204, 274	SFR	89, 102, 131
OC	329	PMSB	83	PWR	342	SFSG	235
ODR	103	PMU	270, 321	PZG	275	SGN	68, 103, 114, 117, 124
OGZ	112, 380	PN	316	PZP	273	SGNB	115
OM	266	POA	283, 366	R		SHHD	309
OMF	267	POB	90, 99	RBM	341	SIK	366
OMNP	267	POP, POP8	408-409	RBMH	341	SIV	264
OMS	267	PP	152-153	RBMI	341	SIZ	82
OMT	267	PPA	152	RC	429	SK	52, 206
OP	166, 367	PPB	154	RCS301	429	SKO	335
OPL	82, 97	PPC	204, 263, 274	RCW	429	SLO	287
OS	400	PPCR	96	RD	263, 278	SMJH	117, 362
		PPG	273	RFM	33, 86	SMSD	117, 362
P		PPH	87	RFS	264, 278	SMT	98
PBB	89, 130	PPL	355	RP	33, 86	SMWH	117, 362
PBC	259	PPM	103, 153	RS	88	SND	88, 102
PBD	122	PPR	152-153	RSB	366	SP	81, 355
PBDW	122, 249	PPRC	245	RVS	103	SP7 Series	239, 243
PBST	266, 329	PPT	73, 314	RW	429	SPB	68, 120
PC	151	PR	85, 316	S		SPBR	238, 288
PCB	112, 380	PRTS	101, 332	SAP	217	SPC	217, 333
PCM	255	PS	148, 330, 409	SAS	105, 144	SPCF	238
PCRC	245	PSB	100, 329	SB	267, 317	SPCH	238
PCSC	244	PSBW	89, 130			SPCN	238
PDG	265, 275	PSC	268, 319			SPCQ	238
PDS	262, 277, 298						

SPCS.....	238	SVM.....	282	USF.....	363	WDP006.....	17
SPCT, SPCTT.....	238	SWA.....	336	UT.....	310-311	WDP007.....	17
SPF1.....	236	SWS.....	336	UTLK.....	311	WDP008.....	18
SPF2.....	54-56, 58-61, 236-237	SWU.....	82	UTPH.....	298, 310	WDP009.....	16
SPF4, SPF6.....	236	SXP.....	250	UTS.....	311	WDP010.....	16
SPFB.....	239			UTSH.....	306	WDP011.....	16
SPFD.....	54-56, 237	T				WDP012.....	22
SPFD2.....	237	T.....	88	V		WDP013.....	21
SPFP2, SPFP4, SPFP6.....	237	TAP.....	166	VC.....	368, 372	WDP014.....	23
SPG.....	355	TB.....	233	VCB.....	368	WDP015.....	23
SPH1, SPH2, SPH4, SPH6.....	236	TBC.....	111	VCCD.....	371	WDP016.....	23
SPHP2, SPHP4, SPHP6.....	237, 432	TBCO.....	111	VCG.....	370	WDP017.....	20-21
SPJH.....	236-237	TBCS.....	111	VCH.....	371	WDP018.....	23
SPJL.....	236-238	TBH.....	94	VCS.....	371	WDP020.....	21
SPJM.....	236, 432	TBN.....	94	VEX.....	369	WDP021.....	22
SPJP.....	236	TCD.....	345	VEXB.....	369	WDP022.....	15
SPM.....	261, 300	TCHS.....	78	VEXS.....	371	WDP023.....	19
SPN2, SPN4.....	236	TCK.....	96, 156	VP.....	204-205, 274, 331, 333, 337	WEG.....	140
SPP.....	272	TCT.....	399	VSS.....	125	WFB.....	266
SPQ2, SPQ4, SPQ6.....	236	TD.....	363, 365	VSW.....	125	WG10.....	138
SPR.....	159	TDAC.....	365	VTS.....	284	WH.....	84
SPS.....	301	TFG.....	96, 156			WHW.....	167, 330, 353, 357
SPS2, SPS4, SPS6.....	236	TGAP.....	211	W		WKCS.....	219
SPSCF.....	238	TGBZ.....	214	W612, W632, W670.....	126	WKR.....	219
SPSCH.....	238, 432	TGET.....	212	WA.....	108-109, 177-178	WLC.....	255
SPSCN, SPSCQ, SPSCS.....	238	TGFP.....	210	WA4.....	109, 178	WMB.....	202
SPSCT, SPSCCT.....	238	TGSP.....	213	WB.....	95, 145, 157	WMW.....	141
SPT2, SPT4, SPT6.....	236	TIM.....	269	WBKG.....	89	WOK.....	219
SPTT2, SPTT4, SPTT6.....	236	TKP.....	275, 323	WBKH.....	78, 84	WP.....	128
SQG.....	332	TKPO.....	258, 323	WBR.....	266	WPB.....	126
SR.....	429	TKPS.....	258, 323	WBRP.....	266	WPC.....	127
SRK.....	242, 378-379	TLC.....	400	WBS.....	155	WPCB.....	127
SRS.....	50, 70, 333	TMT.....	289-291	WC.....	95, 115, 157	WPCT.....	127
SRT.....	284, 335	TN Series.....	322	WCB.....	80, 101, 296	WPG.....	126
SS.....	160, 198, 388	TNH.....	322	WCH.....	111	WPIT.....	127
SSBD.....	122	TNS.....	258, 322	WCS.....	346	WPM.....	81
SSC.....	330	TOS.....	258, 322	WDL001.....	31	WPMP.....	81
SSCH.....	313	TP.....	363	WDM001.....	25	WPP.....	274
SSD.....	265	TPC.....	83, 285	WDM002.....	31	WPS.....	127
SSDB.....	218	TR.....	97	WDM003.....	29	WPST.....	325
SSET.....	215	TRH.....	96, 156	WDM004.....	30	WR.....	343
SSFP.....	216	TSC.....	333, 363	WDM005.....	29	WRP.....	263, 278
SSLB.....	215	TSY.....	97	WDM006.....	31	WS.....	348
SSOP.....	65, 216	TT.....	103	WDM007.....	30	WSK.....	335
SSS.....	324	TIG.....	301	WDM008.....	26	WSP.....	269, 318
SSSP.....	215	TIG5.....	337	WDM009.....	28	WSS.....	348
SST.....	215	TTH.....	363	WDM012.....	27	WWB.....	89
SSTC.....	215-216, 218	TTS.....	399	WDM013.....	28	WWP.....	269, 318
SSTW.....	144	TW.....	105	WDM014.....	27		
ST.....	71-72, 312	TWP.....	193, 299, 323	WDM015.....	26	X	
STB.....	126	TWPO.....	258, 299, 323	WDM017.....	26	XLB.....	143, 425
STH.....	71, 312	TWPS.....	258, 299, 323	WDM019.....	27		
STN.....	338			WDM020.....	24	Z	
STR.....	230	U		WDPO01.....	19	Z-MC.....	128
STRS.....	97, 156	UC.....	382	WDPO02.....	19		
STS.....	70	UNF.....	170-174	WDPO03.....	18		
SUC.....	382	UP.....	283	WDPO04.....	15		
		UPP.....	355	WDPO05.....	17		

DINNERWARE	14
FLATWARE	34
BUFFET SERVICE	54
TABLETOP	74
DINING SERVICE	91
BEVERAGE SERVICE	120

DISPLAY	130
BAR SUPPLIES	135
APPAREL	169
PRO. CUTLERY	183
PRO. COOKWARE	209
STEAM TABLE PANS	236

POLY PANS/STORAGE	243
BAKEWARE	250
PIZZA SUPPLIES	271
FOOD PREP	282
KITCHEN UTENSILS	297
JANITORIAL	341

SHELVING & RACKS	368
BUSSING/TRANSPORT	374
COUNTERTOP EQUIPMENT	388
MERCHANDISING DISPLAYS	461

Index by ITEM NAME
Red indicates NEW item

A

ACERO.....52, 184-187, 197-198, 200-203, 206, 334, 338

Adaptor Bar239

Adaptor Plate, Cast Iron.....445

Adaptor Plate, S/S.....241, 435

Adaptor Ring430

Adaptor, Display.....132, 239

Aerator, Wine.....155

After 5™136-137

Air Freshener, Automatic364

Airpots & Racks123

Allergen-Free228, 244, 251, 262, 277, 292, 298-299

Apple Corer331

Apple Divider333

Apple Peeler, Countertop...284

Apron, Bib106-108, 175-177

Apron, Bistro108-109, 177-178

Apron, Disposable179, 354

Apron, Utility.....179, 354

Apron, Waist.....109, 178

Ardesia™15-31

Ashtray105, 144

Au Gratin Dish.....82

B

Backpack, Delivery.....281, 385

Backpack, Knife203

Bag, Delivery...280-281, 385-386

Bag, Janitorial.....345

Bag, Knife203

Bag, Vacuum.....439

Bagel Slicer.....100, 284

Baguette Pan.....253

Bain Maries.....240-241, 302

Baking Mats, Silicone....251, 298

Baking Pan229

Bar Liners & Mats.....158

Bar Maid51, 66, 124, 139-141, 143, 145, 148, 150-151, 155, 159-166, 262, 269, 277, 318, 331, 359, 367, 388-395, 409, 425

Bar Shakers & Cups.....136-138

Basket, Breeding.....328

Basket, Culinary328

Basket, Doughnut.....257

Basket, Flatware.....112, 380

Basket, Fryer231, 233

Basket, Pasta.....231, 324

Basket, Plastic90, 99

Basket, Serving, Mini.....78

Basket, Serving, Wire.....89

Basket, Steamer, S/S.....230

Basket, Woven.....90, 131

Baster.....266, 329

Basting Fork, Nylon317

Basting Utensils, S/S.....305, 313-314

Batter Dispenser.....264, 288

Bell, Call.....103

BenchMarkUSA™152, 404-415, 417-421, 427, 432-433, 441

Beverage Dispenser66-67, 120-122, 249, 427

Beverage Dispenser, Insulated.....124

Beverage Display, Electric...424

Beverage Server, Insulated.125

Beverage Server, S/S.....126

Bin, Flatware & Cutlery.112, 380

Bin, Ingredient247, 383

Blade Station™196

Blender, Electric143, 425

Blender, Pastry.....263

Board, Marker.....119, 134

Booster Seat.....113

Bottle Cap Catch.....147

Bottle Opener.....147

Bottle Stopper.....155

Bottle Well.....159

Bottle, Cleaning167, 354

Bottle, Flair154

Bottle, Squeeze100, 329

Bowl, ABS89, 130

Bowl, Display.....130

Bowl, Kady.....77

Bowl, Melamine25-30, 32-33

Bowl, Mixing286

Bowl, PC.....89, 130

Bowl, Porcelain..15, 17-18, 20-22

Bowl, Punch68, 120

Bowl, Salad.....89, 130

Bowl, Salsa.....26, 83

Bowl, Sugar.....88

Bowl, Wood.....89

Box Cutter.....353

Bracket, Wall-Mount353

Brazier, Alu226-227

Brazier, S/S.....214-215

Bread Board.....80, 101, 296

Bread Pan.....253

Briquette Rocks448

Broom Heads & Handles.....351

Broom, Lobby112, 351

Brush, Basting.....266

Brush, Bottle.....294, 358

Brush, Broiler360

Brush, Butcher Block.....360

Brush, Coffee Decanter.....128, 359

Brush, Counter.....358

Brush, Cutting Board....295, 358

Brush, Equipment.....128, 359

Brush, Floor Scrub.....351

Brush, Fryer.....359

Brush, Glass359

Brush, Grill.....360

Brush, Nail358

Brush, Oven.....360

Brush, Pastry266

Brush, Pizza Oven.....279, 360

Brush, Pot228, 359

Brush, Scratch.....361

Brush, Silicone267, 317

Brush, Tap.....166

Brush, Toilet363

Brush, Utility, Mini361

Brush, Vegetable294, 358

Bucket, Cleaning.....355

Bucket, Ice.....149

Bucket, Mop.....346

Bucket, Wine.....95, 157

Bulb, Heat Lamp435

Bulk Knives, Pairing192

Bulk Knives, Sandwich Spreader.....193, 323

Burger Peel274, 338

Burger Press.....336, 397

Bus Box & Cover.....381, 414

Bus Box Cart383

Butane Gas Stove.....437

Butter Curler331

Butter Roller238, 288

Butter Warmer88, 102

C

Caddy, Bar.....142

Caddy, Check103

Caddy, Janitorial.....344-345

Caddy, Tabletop84

Cadenza™128

Cake Decorating Comb....258

Cake Decorating Tips.....259

Cake Leveler, Wire255

Cake Marker.....253, 255

Cake Pan.....252, 254-255, 272

Cake Stand & Cover ...133, 258

Call Bell.....103

Can Opener, Counter Mount.....396

Can Opener, Handheld146, 334

Can Storage Rack.....373

Can Tapper.....147

Cap, Tap.....166

Carafe, Insulated.....125

Cart, Bus Box.....383

Cart, Concession.....404, 408, 412, 414

Cart, Janitorial.....345

Cart, Keg & Pail.....165

Cart, Lug Box383

Cart, Trash Can342

Cart, Utility382

Casino Chip Cleaning, Electric.....394

Casserole, Mini.....75-76

Caster, Sheet Pan Rack374-377, 379, 383

Caster, Steam Pan Rack.....242, 378-379

Caster, Universal374

Chafer54-61

Chafer Fuel Can62

Chafer Stand, Wire.....62

Chair, High.....113

Charbroiler, Gas.....448

Check Service.....103

Cheese Board80, 101, 296

Cheese Grater101, 331-332

Cheese Knife205

Cheese Knife Set101, 205

Cheese Plane.....331

Cheese Slicer, Countertop .399

Cheese Slicer, Handheld....332

Cheese Slicer, Wire.....332

Chef Hat179-180

Chef Jacket170-171

Chef Pants173-174

Chef Shirt172

Cherry Corer333

Chinois Pestle.....325

Chopper/Dicer.....284

Chopper/Dicer, Countertop401

Cleanout Rod.....235, 339

Cleaver201

Clip, Table.....111

Cloth, Table.....111

Coaster, Wine95, 157

Coat Check.....111

Cocktail Picks99, 144

Cocktail Shaker.....136-138

Coffee Accessories.....128-129

Coffee Server, Insulated.....125

Coffee Server, S/S.....126, 128

Coffee Urn.....66, 120

Coffee Urn, Electric426-427

Colander, Alu287

Colander, Food Storage Box.....246

Colander, Mini.....77

Colander, S/S.....287

Colander, Scoop.....325

Condiment Caddy & Holder, Bar142

Condiment Caddy & Holder, Tabletop.....84

Condiment Dispenser, S/S.....86, 100, 288, 419

Condiment Jar & Covers.....88

Condiment Packet Holder, S/S.....104

Cone Holder, Acrylic132

Connector Strip.....235, 339

Connoisseur231, 324

Container, "Ice Only"149

Container, Food Storage.....244-245, 248

- Conveyor Toaster.....440
 Cookie Cutter.....260
 Cookie Sheet.....257
 Cooking Tools, Nylon.....317
 Cookware Set, S/S.....217
 Cookware, Cast Iron.....221
 Cookware, Mini.....76-7
 Cookware, Mini, Cast Iron.....74
 Cookware, Mini, Try-Ply.....75
 COOL HEAT Turners.....322
 Corer, Apple.....331
 Corer, Cherry.....333
 Corer, Pineapple.....333
 Corer, Tomato.....331, 333
 Corkscrew.....146
 Cotton Candy Equipment & Supplies.....412-413
 Countertop Safety Shields.....91
 Cover, Bain Marie.....240-241, 302
 Cover, Basting.....339
 Cover, Cookware, Alu.....224, 226-228
 Cover, Cookware, S/S.....215-216, 218
 Cover, Display, PC.....132, 243
 Cover, Display, S/S.....132, 238
 Cover, Food Pan, PC.....243
 Cover, Food Storage Box.....246
 Cover, Food Storage Container 244-245, 248, 298
 Cover, Inset.....240-241, 302
 Cover, Plate.....96
 Cover, Sheet Pan.....251
 Cover, Sheet Pan Rack.....379
 Cover, Steam Table Pan.....238-239, 243, 432
 Cover, Wok.....219
 Creamer Server, Insulated..125
 Creamer, S/S.....87
 Crock, Deli.....131, 248
 Cruet, Oil & Vinegar.....84
 Cup Dispensers, Racks, & Organizers.....129
 Cup, Measuring.....270, 320-321, 409
 Cup, Melamine.....33
 Cup, Mint Julep.....79, 144
 Cup, Porcelain.....18
 Cup, Ramekin.....33, 86
 Cup, Sauce.....86
CURV™.....73, 313, 315
 Cutlery Bin.....112, 380
Cutlery Polisher.....51
 Cutter, Cookie.....260
 Cutter, Doughnut.....260
 Cutter, Pastry.....260
 Cutting Board, 141, 292-295, 298
 Cutting Board Rack.....294
 Cutting Board, Wood.....296
 Cutting Mat.....295
- D**
 Decal, Floor.....115
 Decanter, Coffee.....129
 Decanter, PC.....127
 Decorating Comb.....258
 Decorating Tips.....259
 Deep Fryer, Countertop.....443
 Deli Crock & Cover.....131, 248
 Dinnerware, Melamine.....24-33
 Dinnerware, Porcelain.....15-23
 Dinnerware, Slate.....31
 Dipper, Ice Cream.....308
 Dipper, S/S.....309
 Dish Box & Cover.....381, 414
 Dish, Dessert.....86, 88
 Dish, Porcelain.....15, 20-23
 Dish, S/S.....82
 Dish, Snail.....88, 102
 Dishwasher.....299, 307-308
 Dispenser, Batter.....264, 288
 Dispenser, Beverage.....427
 Dispenser, Brick Packs.....347
 Dispenser, Condiment.....86, 100, 288, 419
 Dispenser, Cup.....129
 Dispenser, Napkin.....104
 Dispenser, Paper Towel.....365
 Dispenser, Powder Sugar.....265
 Dispenser, Sanitizer.....104
 Dispenser, Soap.....364
 Dispenser, Straw.....104, 145
 Dispenser, Syrup.....87, 329
 Dispenser, Toilet Seat Cover.....363
 Dispenser, Toilet Tissue.....363
 Dispenser, Toothpick.....104
 Dispenser, Topping.....427
 Dispenser, Whipped Cream.....259, 300
 Display Adaptor.....132, 239
 Display Bowl.....130
 Display Case, Acrylic.....133
 Display Pan, S/S.....65, 216
 Display Tray, Acrylic.....130
 Display Tray, S/S.....69, 130
 Display, Heated Merchandiser.....420-423
 Display, Refrigerated.....424
 Dolly, Dough Box.....249, 276, 379
 Dolly, Food Transporter.....384
 Dolly, Trash Can.....342, 344
 Dome Cover, PC.....132, 243
 Double Boiler, S/S.....218
 Dough Box Dolly.....249, 276, 379
 Dough Box & Cover.....249, 262, 276
 Dough Divider.....263, 278
 Dough Pan & Cover.....262, 276
 Dough Roller Docker.....263, 278
Dough Scraper.....262, 277, 298
 Doughnut Cutter.....260
 Drain Shelf, PC.....243, 246
Drain, Bar.....165-166, 367
 Drain, Floor.....348
Drain, Pipe.....166, 367
Drain, Trap.....166, 367
 Dredges.....265, 275
 Drinkware, Bar.....79, 138, 144
 Drinkware, Plastic.....127
Drip Trays.....66, 124
 Dump Station Pan Holder.....434
 Dunnage Rack.....372
 Dust Mop.....350
 Dust Pan.....112, 352
- E**
 Easel.....119, 134
 Egg Poacher Set.....217
 Egg Ring.....338
 Egg Separator.....335
 Egg Slicer.....335
 Elemental Aluminum 4mm.....227
 Elemental Aluminum 6mm.....226
Empanada Fork.....285, 335
 Eraser, Marker Board.....119, 134
 Extender, Sheet Pan.....251
- F**
 Face Masks.....110, 169
 Face Shield.....110
 Fajita Server.....82, 219
 False Bottom, S/S.....239
 Faucet.....66-67, 120-122, 249
 Filter, Fryer Stand.....234, 339
 Filter, Hood.....366
 FireIron™.....74-75, 221
 Fish Bone Tweezers.....337
 Fish Scaler, S/S.....337
 Fish Spatula.....299, 322-323
 Fish Spatula, Nylon.....317
 Flair Bottle.....154
Flatware.....34-53
 Flatware Cylinder & Organizer.....112, 380
Flatware Polisher, Electric.....395
Floor Cleaning.....348
 Floor Decal.....115
 Floor Mat.....341
 Food Cooker & Warmer, Electric.....430-433
 Food Marker, Bamboo.....298
 Food Markers, Steak.....336
 Food Mill.....282
 Food Pan Rack.....242, 378
 Food Pan, Chafer 54-61, 236-237
 Food Pan, PC.....243
 Food Storage Box, PC.....246
 Food Storage Box, PP.....246
 Food Storage Container.....244-245, 248
 Food Transporters, Insulated.....384
 Fork, Basting.....314
 Fork, Cook's.....186, 338
Fork, Empanada.....285, 335
 Fork, Pasta.....317
 Fork, Pot.....338
 Fork, Serving, S/S.....34, 70-71
 Fork, Snail.....88, 102
 French Fry Bagger.....234, 339
 French Fry Cutter.....402
 Frothing Pitcher.....128
 Fruit & Vegetable Slicer.....398
 Fruit & Wedger Slicer, Countertop.....401
 Fry Basket.....231, 233
 Fry Basket Accessories.....234
 Fry Basket, Mini.....78
 Fry Cup.....78
 Fry Pan, Alu.....224-225
 Fry Pan, Carbon Steel.....218
 Fry Pan, Mini.....75-76
 Fry Pan, S/S.....210, 216
 Fry Server, Wire.....78
Fryer Accessories.....235, 339
 Fryer Filter Stand.....234, 339
 Fryer Pan, Alu.....231
 Fryer Screen.....339
 Fryer Splash Guard.....235
 Fuel Holder.....54-63
 Fuel, Chafer.....62
 Funnel.....264, 328
- G**
 Garlic Press.....335
 Gladiator™ Fry Pans.....225
Glass Cleaning Supplies.....162, 391
 Glass Hanger Rack.....159
Glass Polisher, Electric.....51, 392-393
Glass Polisher, Manual.....164, 393
 Glass Rimmer.....141
Glass Washer, Electric.....160-161, 163, 388-390
Glass Washer, Manual.....164, 359
 Glasses, Drinkware.....138
 Glove Box Bracket.....353
 Gloves, Cotton.....111, 178
 Gloves, Cut Resistant.....199
 Gloves, Latex.....353
 Gloves, Nitrile.....353
 Gloves, Poly.....353
 Gloves, Protective Mesh.....199, 337
 Grapefruit Spoon.....50, 333
 Grate, Sheet Pan.....251
 Grate, Steam Table Pan.....239
 Grater.....101, 331-332
 Gravy Boat.....87
 Griddle.....219
 Griddle Plate, Cast Iron.....445
 Griddle, Electric.....447
 Griddle, Gas.....449
 Grill Cleaners.....361
 Grill Pan, Cast Iron.....221
 Grill, Panini.....445
 Grill, Sandwich.....444-445
 Grinder, Meat.....397
 Grinder, Salt & Pepper.....81
 Guest Check Holder.....103
 Gyro Pan.....230
- H**
Hamburger Press.....336, 397
 Hangers, Coat.....111
 Headwear.....179-180
 Heat Lamp.....435
 High Chair.....113
Holder, Towel.....167, 357
 Holloware, Stainless Steel.....128
 Hood Filter.....366
 Hook, Pot.....217
 Hook, Shelving.....368-369
 Hot Dog Equipment & Supplies.....416-419
 Hot Plate, Gas.....450
 Hottle, Glass.....126
- I**
 Ice Bucket.....149
 Ice Caddy, Insulated.....149, 384
 Ice Cream Dipper.....308
 Ice Cream Spade.....308
 Ice Crusher.....149
Ice Cube Tray.....148
 ICE ONLY Container.....149
 Ice Scoop.....148, 330

Ice Tools..... 148
Immersion Circulator.....438
 Impulse Sealer.....439
 Induction Cooker
 64-65, 436-437
 Ingredient Bin.....247, 383
 Inset.....
 63, 240-241, 302, 428, 430, 432

J

Jacket, Chef 170-171
 Jigger..... 136-137, 139
 Juice Dispenser...66-67, 120-121
 Juice Pour Bottle 154
 Juicer, Citrus.....140, 333
 Juicer, Countertop.....140, 285

K

Kady Bowl..... 77
 KATTEX™ 397-402
 Knife Bag.....203
 Knife Bag Set.....187, 193
 Knife Block Set 187
 Knife Guard.....202
 Knife Holder, Magnetic202
 Knife Rack.....202
 Knife Sharpener 196-197
 Knife, Boning.. 184, 188, 190, 194
 Knife, Bread.....
 186, 188, 190, 192, 195, 299
 Knife, Breaking..... 191
 Knife, Butcher..... 192
 Knife, Carving.....70
 Knife, Cheese 101, 205
 Knife, Chef's.....
 185, 189, 191, 195, 299
 Knife, Chopping.....204
 Knife, Cimeter 189, 191
 Knife, Fillet 186, 188
 Knife, Hobby 199, 259
 Knife, Lettuce..... 333
 Knife, Mezzaluna.....204
 Knife, Nakiri..... 184
 Knife, Oyster 205, 331, 337
 Knife, Paring.....
 184,188, 190, 192, 194, 199, 299
 Knife, Pastry 188
 Knife, Peeling 184
 Knife, Pizza204, 274
 Knife, Santoku. 184, 189, 191, 195
 Knife, Slicer 70, 186, 189, 192
 Knife, Steak.....52-53, 206-207
 Knife, Tomato..... 184
 Knife, Utility..... 184, 188, 190, 199

L

Ladle, Mini270, 320
 Ladle, Nylon317
 Ladle, S/S..... 299, 303, 309, 432
 Ladle, Serving S/S.....70-71
 Ladle, Serving, PC 73, 315
 LED Sign..... 118
 Lettuce Cutter, Countertop400
 Lettuce Knife.....333
 Liner, Bar..... 158
 Liquor Pour Bottle..... 154
Liquor Pourer..... 150-153
 Loaf Pan.....252, 257
 Lobster Cracker.....102, 337

Lug Box..... 381
 Lug Box Cart383

M

Maestro™ 81
 Majestic™ Fry Pans 225
 Mandoline Slicers 283
 Marker Board.....119, 134
 Marker, Cake 253, 255
 Marker, Neon.....119, 134
 Masher 316-317
 Masks, Face 110, 169
Mat, Bar..... 158
 Mat, Floor 341
 Measuring Cups
 270, 320-321, 409
 Measuring Spoons270, 320
 Meat Grinder.....397
 Meat Tenderizer336
 Melamine Dinnerware..... 24-33
 Melon Baller331, 333
 Menu Cover.....92-93
 Menu Holder Clips.....68, 94
 Menu Stand, Acrylic 93
 Menu Tent.....92
 Merchandiser, Electric .420-423
 Microwave442
 Milk Can, Mini 79
 Mitt, Oven.....267
 Mixer, Electric.....446
 Mixing Bowl286
 Mixing Bowl Stand286
 Mixing Paddles..... 269, 277, 318
 Mold, Pastry261, 300
 Mop Bucket.....346
 Mop Handle347
 Mop Head, Dust350
Mop Head, Wet347
 Mortar & Pestle..... 141, 284
Muddler141
 Muffin Pan 256-257
 Mug, Melamine 33
 Mug, Moscow Mule..... 79, 144

N

Nacho Equipment &
 Supplies.....420
 Napkin Dispenser 104
 Nut Cracker..... 102, 334, 337

O

Oil & Vinegar Cruets84
 Oil Can329
 Oil Mop266
 Onion Slicer, Countertop.....400
 Order Rack.....103
 Organizer, Cup & Lid 129
 Oven Mitt 267
 Oven, Electric 441

P

Paddles 269, 277, 318
 Paella Pan 218
 Pail Opener..... 283, 366
 Pail, Mini 79
 Pail, Utility 283, 355
 Pan, Carbon Steel, Mini 77
 Pan, S/S.....65, 216

Panini Grill445
 Pants, Chef..... 173-174
 Paper Towel Dispenser.....365
 Pasta Basket..... 231, 324
 Pasta Cooker Set, S/S.....230
 Pasta Fork 70, 317
 Pasta Maker.....285
 Pastry Bag.....259
 Pastry Blender.....263
 Pastry Brush266
 Pastry Cutter260
 Pastry Mold261, 300
 Pastry Wheel.....263
 Patty Press 397
 Pedestal, Concession .405-407
 Peeler, Apple, Counterop...284
 Peeler, Vegetable331, 333
 Pen, Counterfeit Detection. 103
 Peppermill 81
 Pestle, Chinois.....325
 Picks, Decorative 99, 144
 Picks, Seafood.....102, 337
 Pie Cutter.....255
 Pie Pan255
 Pie Server 70, 299, 322-323
 Pineapple Corer333
 Pipe, Overflow..... 166, 367
 Pitcher, Plastic..... 127
 Pitcher, S/S 126
 Pitcher, S/S, Frothing 128
 Pitcher, Syrup/Cream 86
 Pizza Bubble Popper.....273
 Pizza Cutter 204, 274, 331
 Pizza Delivery Bag
 280-281, 385-386
 Pizza Knife204, 274
 Pizza Merchandiser 421-423
 Pizza Oven..... 441
 Pizza Pan271-272
 Pizza Pan Gripper 273
 Pizza Pan Rack273, 377
 Pizza Pan Stand, Tabletop...272
 Pizza Peels..... 274, 338
 Pizza Screens..... 272
 Pizza Server.....275
 Pizza Serving Tongs.....275
 Plate Covers..... 96
 Plate, Melamine
 24-26, 28, 30-32
 Plate, Porcelain 15-17, 20, 22
 Plate, Salsa 83
 Plating Tools..... 301
 Platter, Melamine27, 31-32
 Platter, Plastic 90, 99
 Platter, Porcelain..... 19-21
 Platter, S/S..... 82, 97
 Platter, S/S, Mini80
 Platter, Sizzling..... 82
 Platter, Slate 31
 Plunger363
Polisher, Flatware 51
Polisher, Glass 164
**Popcorn Equipment &
 Supplies**.....404-411, 415
 Porcelain Dinnerware 15-23
 Portioner 299, 304, 308-309
 Pot Holder.....267
 Pot Hook.....217
 Potato Ricer316

Pourer Bottle, Liquor &
 Juice 154
Pourer, Liquor..... 150-153
Pourer, Wine..... 155
 Proofing Pan & Cover...262, 276
 Pullman Pan & Cover252
 Pump Kit..... 154, 288, 362
 Pur-Clean™364-365

Q

Quiche Pan.....255

R

Rack, Can Storage 373
 Rack, Cup 129
 Rack, Cutting Board294
 Rack, Dunnage 372
 Rack, Glass Hanger 159
 Rack, Icing/Cooling.....257
 Rack, Knife Storage.....202
 Rack, Mop & Broom352
 Rack, Order.....103
 Rack, Pizza Pan273, 377
 Rack, Seafood 89, 102, 131
 Rack, Sheet Pan.....374-377
 Rack, Steamer.....230
 Rail, Speed 159
 Ramekins33, 86
 Refrigerated Beverage
 Display.....424
 Relish Server88
 Restroom Necessities.....363
 Rice Cooker & Warmer.....429
 Roasting Pan.....229
 Roasting Pan, Mini.....77
 Rolling Pin.....263, 278

S

Salad Bowl 89, 130
 Salsa & Dip Service83
 Salt & Pepper 81, 85
Salt, Margarita..... 141
 Sandwich Grill 444-445
 Sandwich Spreader
 193, 299, 322-323
 Sanitizer Dispenser..... 104
 Sauce Cup, S/S.....86
 Sauce Pan, Alu.....228
 Sauce Pan, Mini75-76
 Sauce Pan, S/S.....211, 215, 217
 Sauce Pot, Alu.....226-227
 Saucier, Mini75
 Sauté Pan, Alu 224, 227
 Sauté Pan, S/S..... 212, 215
 Scale, Digital..... 282
 Scale, Mechanical282
Scoop Holder.....330-331
 Scoop, Alu.....330
 Scoop, Coffee.....128
Scoop, Plastic... 148, 330-331, 409
 Scoop, S/S..... 148, 330
 Scouring Pad.....355
 Scrap Block.....366
 Scraper, Cooking322-323
Scraper, Dough.....262, 277, 298
 Scraper, Grill.....361
 Scraper, Pizza Oven.....279, 360
 Scraper, Plastic268, 319
 Scraper, Silicone.....268, 319

- Screen, Fryer 235, 339
Screen, Pizza..... 272
Screen, Urinal..... 363
Seafood Preparation 337
Seafood Service
89, 102, 131, 337
Seafood Tray & Rack..89, 102, 131
Sealer, Impulse 439
Sealer, Vacuum 439
Seat, Booster..... 113
Serrator 284, 335
Server Book..... 103
Server, Coffee/Cream 87, 126, 128
Server, Relish 88
Server, S/S..... 87
Serving Board, Marble &
Wood 80
Serving Board, Wood 80, 101, 296
Serving Tray, Aluminum 98, 250
Serving Tray, Chrome
Plated..... 69, 97
Serving Utensils, PC 73, 314-315
Serving Utensils, S/S.....
34, 70-72, 148, 311-312, 419
Shaker, Bar..... 136-138
Shaker, Glass 85
Sharpener, Knife..... 196-197
Sharpening Guide 198
Sharpening Steel 187, 198
Sharpening Stone..... 198
Shears 200, 334
Sheet Pan Accessories 251
Sheet Pan Extender 251
Sheet Pan Grate 251
Sheet Pan Rack..... 374-377
Sheet Pan Rack Accessories..379
Sheet Pan Truck..... 377
Sheet Pan, Alu..... 229, 250, 441
Sheet Pan, S/S 250
Sheet Tray, Plastic..... 251
Shelves, Wire..... 368-369
Shelving Cart..... 371
Shelving Parts & Accessories.....
368-369, 371-372
Shelving Sets..... 371
Shelving, Security Cage..... 370
Shield, Countertop..... 91
Shield, Face 110
Shirt, Chef..... 172
Shooter Tubes..... 145
ShowTime! Equipment
408-409, 412-413
Shrimp Deveiner..... 337
Sieve, S/S 264
Sifter 139, 265
Sifter, Rotary 264, 278
Sign, Clip & Holders..... 68, 94
Sign, Concession
409, 413, 415, 421
Sign, Floor, Caution 346
Sign, Hostess 116
Sign, Information..... 114-115
Sign, LED..... 118
Sign, Stanchion..... 116-117, 362
Sign, Tabletop 68, 103, 124
Sign, Window Cling..... 115
SignatureChef™ Apparel.....
106-110, 169-178, 180
Sizzling Platter 82
Skewers..... 335
Skillet, Cast Iron 221
Skimmer, Nickel Plated 326
Skimmer, Nylon..... 317
Skimmer, S/S..... 326
Slate Dinnerware..... 31
Sleeve, Pan Handle .219, 228, 298
Slicer, Bagel..... 100, 284
Slicer, Countertop
Equipment..... 398-401
Slicer, Egg 335
Slicer, Mandoline 283
Slicer, Turning 284
Slicer, Wire..... 332
Snail Service..... 88, 102
Snow Cone Equipment &
Supplies..... 414-415
Soap Dispenser..... 364
Soap Dispenser Stanchion
Mount..... 117, 362
Sof-Tek™ 188-189, 199, 204, 274
Soup Warmer, Fuel..... 63
Soup Warmer, Electric..... 428, 433
**Sous Vide Equipment &
Accessories 438-439**
Spaghetti Server 70
Spatula, Bakery 258, 299, 322-323
Spatula, Cooking 299, 322-323
Spatula, Cooking, Nylon..... 317
**Spectrum™ 64-65,
416, 436-440, 442, 446-450**
Speed Rail..... 159
Spillage Pan..... 237
Sponges..... 355
Spoon, Bar..... 136-137, 139
Spoon, Basting..... 313-314
Spoon, Buffet, PC..... 73, 315
Spoon, Grapefruit..... 50, 333
Spoon, Measuring..... 270, 320
Spoon, Nylon..... 269, 317-318
Spoon, Plating, S/S..... 301
Spoon, Serving, PC 73, 315
Spoon, Serving, S/S..... 34, 70-71
Spoon, Wood..... 269, 318
Spreader..... 269, 318
Spreader, Sandwich.....
193, 299, 322-323
Springform Pan..... 254
Squeezegee..... 348
Squeeze Bottle..... 100, 329
Squeezer, Citrus..... 140, 285, 333
sTABLEizer..... 105
STÅL..... 190-195, 299
Stand, Equipment 446, 451
STATIKBOARD™
141, 292-293, 298, 398
Steak Knife..... 52-53, 206-207
Steak Markers..... 336
Steak Server..... 82, 219
Steak Weight 336
Steam Table Pan 236-237, 432
Steam Table Pan Accessories 239
Steam Table Pan Cover
238-239, 243, 432
Steam Table Pan Rack 242, 378
Steamer Basket 230
Steamer Rack..... 230
Steamer Set, S/S..... 218
Stir Fry Pan, Alu 230
Stirring Paddles 269, 318
Stock Pot, Alu..... 226-227
Stock Pot, S/S..... 213, 215
Stove, Butane Gas..... 437
Stove, Stock Pot, Gas..... 447
Strainer, Bar 136-137, 139
Strainer, Bouillon 325
Strainer, China Cap 325
Strainer, Mesh.... 139, 265, 325, 327
Strainer, Sink 366
Strainer, Spaghetti 324
Straw Dispenser..... 104, 145
Straw, S/S..... 144
Strip Heater 434
Sub Sandwich Roll Pan..... 253
Sugar Bowl 88
Sugar Can 88
Sugar Packet Holder 87
Sweeper, Rotary..... 112, 352
Syrup Dispenser..... 85, 87, 329
Syrup Pitcher..... 86
T
Table Cloth..... 111
Table Crumber 102
Table Numbers..... 94
Table Wedges 105
Taco Holder & Server..... 78
Tea Infuser Ball..... 126
Tealights 105
Teapot, Glass 126
Teapot, S/S..... 126
Tenderizer, Meat 336
Thermal Circulator..... 438
Thermometer 289-291
Tickets, Coat Check 111
Timer..... 269
Toaster, Conveyor..... 440
Toilet Seat Covers &
Dispenser 363
Toilet Tissue Dispenser &
Holder..... 363
Tomato Corer 331, 333
Tomato Slicer, Countertop. 399
Tongs, Flat, PC..... 73, 314
Tongs, Ice, S/S 72, 148, 311
Tongs, Pastry, S/S 72, 312
Tongs, Pizza..... 275
Tongs, Plating, S/S 301
Tongs, POM, S/S 72, 148, 311, 419
Tongs, Salad, S/S 72, 312
Tongs, Serving, PC 73, 315
Tongs, Serving, S/S 71, 312
Tongs, Snail..... 88, 102
Tongs, Spaghetti, PC 73, 314
Tongs, Spaghetti, S/S..... 71, 312
Tongs, Utility, S/S.....
298, 306, 310-311
Toothpick Dispenser..... 104
Tortilla Press..... 83, 285
Tortilla Warmer..... 83
Towel, Cleaning..... 167, 357
Trap, Drain 166, 367
Trap, Fruit Fly 164
Trash Can Caddy 345
Trash Cans & Lids 342-344
Tray Stand 97
Tray, Dining, Alu 98, 250
Tray, Dining, Plastic 98
Tray, Dining, S/S..... 98
Tray, Display, Acrylic..... 130
Tray, Display, S/S 69, 130
Tray, Drip..... 66, 124
Tray, Ice Cube 148
Tray, Porcelain 20, 22
Tray, Seafood..... 89, 102, 131
Tray, Serving, Chrome
Plated 69, 97
Tray, Serving, Cork-Lined 96, 156
Tray, Serving, Fiberglass.. 96, 156
Tray, Serving, Rubber-
Lined 96, 156
Tray, Serving, S/S..... 80, 97, 156
Tray, Tip 103
TRI-GEN™ Cookware 210-214
Trolley, Utility..... 382
Tumbler, Plastic 127
Turner, Cooking 299, 322-323
Turner, Pancake 338
Turner, Serving, S/S..... 70, 338
Turning Slicer 284
Tweezers, Fish Bone 337
Twist & Out™ 146, 334
U
Underliner 75, 82, 219, 221
Urinal Screen..... 363
Utility Cart 382
Utility Pail 283, 355
Utility Trolley 382
V
Vacuum Sealer..... 439
Vegetable Peeler 331, 333
Virtuoso™ 54, 66, 120
W
Waffle Maker 440
Waste Basket..... 342
Waste Can, Mini..... 105
Waste Receptacle..... 343
Water Boiler..... 427
Water Pan 54-61, 63, 237
Water Pan, Electric..... 63, 428
Wedge..... 140
Whip, Nylon..... 317
Whip, S/S..... 316
Whipped Cream
Dispenser 259, 300
Winco® Prime
234, 240, 302-307, 339
Window Cleaning..... 348
Window Cling 115
Wine Accessories 155
Wine Service 95, 157
WinGo Bag™ 280-281, 385-386
Wipe Container Stanchion
Mount..... 117, 362
Wipes Canister Bracket 353
Wire Grate, Sheet Pan..... 251
Wire Grate, Steam Table Pan 239
Wok, Mini 76
Woks & Accessories..... 219
Wristbands 145
Z
Zester..... 101, 331-332

- WINCO PRODUCTS - MERCHANDISING DISPLAY PROGRAMS

SLATWALL DISPLAY

FLATWARE DISPLAY BOARDS

Available with qualifying order

1 display per location



FRM-SERIES (18/0)



FRM-SERIES (18/8)



No lost display pieces!

*All 25 Winco
Flatware Patterns
Available on
Display Boards*

Slatwall hooks
included.



**See your sales rep for details
of all display programs**

- WINCO PRODUCTS - MERCHANDISING DISPLAY PROGRAMS

SIGNATURE **CHEF**

APPAREL RACK

Available with
qualifying order

1 display per location

Color Box is available
with each FC/full case
purchase per item.

SELECT ITEMS



See your sales rep
for program details

Holds 24 Cases

- WINCO PRODUCTS - MERCHANDISING DISPLAY PROGRAMS

MOP & BROOM WINGSTACK

Available with
qualifying order

1 display per location



See your sales rep
for program details



*Fill with mops, brooms...
anything with a handle*



LIMITED WARRANTY ~ ELECTRIC AND GAS EQUIPMENT

WINCO® warrants to the original purchaser of new electrical and gas equipment of our manufacture, when installed properly within USA and Canada, and subjected to normal use, is free from defects in material or workmanship for a period of one (1) year. Coverage for customers outside of the USA and Canada will be for parts only.

Determination of repair or replacement will be at the sole discretion of Winco.

EXCLUSIONS: Light bulbs, blades or coatings are not covered under said warranty. The labor warranty is one (1) year from original purchase date, or 18 months from actual factory shipment date, whichever date occurs first.

WINCO'S OBLIGATION AND LIABILITY UNDER THIS WARRANTY IS EXPRESSLY LIMITED TO REPAIRING AND REPLACING EQUIPMENT THAT PROVES TO BE DEFECTIVE IN MATERIAL OR WORKMANSHIP, WITHIN THE APPLICABLE WARRANTY PERIOD.

IN NO EVENT SHALL WINCO BE LIABLE FOR INCIDENTAL OR CONSEQUENTIAL DAMAGES TO BUYER OR ANY THIRD PARTY, INCLUDING AND WITHOUT LIMITATION: LOSS OF PROPERTY, PERSONAL INJURY, LOSS OF BUSINESS OR PROFITS, OTHER ECONOMIC LOSSES, OR STATUTORY OR EXEMPLARY DAMAGES, WHETHER IN NEGLIGENCE, WARRANTY, STRICT LIABILITY, OR OTHERWISE.

This warranty applies only to the first purchaser from a retail dealer. No warranty is given to subsequent transferees. A copy of the original receipt or proof of purchase directly from Winco or Winco's authorized dealer/distributor is required for warranty coverage. **This warranty is not in force until such time as a properly completed and digitally signed Installation/Warranty Registration has been received by WINCO within 30 days from the date of installation.**

This warranty is void or does not cover damage caused by improper installation and/or use, neglect, failure to properly maintain, modifications, damage due to excessive water or fire, serial plate is defaced, product is installed in a prison or correctional facility, or normal wear. Periodic maintenance is not covered.

DO NOT send unit to WINCO without first contacting our customer service department.

To submit an EQUIPMENT warranty claim, contact Winco through the Warranty/Service Online Portal:
www.wincous.com/contact-us/product-technical-support

LIMITED WARRANTY ~ SHELVING

WINCO® warrants that **shelving products** of our manufacture, when properly installed within USA and Canada and subjected to normal use, are free from defects in material or workmanship for a period of up to five (5) years.

Determination of repair or replacement will be at the sole discretion of Winco.

This warranty does not cover damage caused by improper installation and/or use, overloading, accident, improper storage, or neglect, alterations, modifications, or additions.

LIMITED LIFETIME WARRANTY ~ CUTLERY AND TURNERS

All WINCO® **Acero™, Stal™, and CoolHeat™ products** are guaranteed against defects in workmanship and material for the life of the product.

Our products are designed to last when used as intended. The sole and exclusive remedy under this warranty is the replacement or repair of the defective product. Winco reserves the right to inspect products for misuse.

WARRANTY EXCLUSIONS

This warranty does not cover against misuse or any other subsequent conditions such as those attributable to the use of the product for purposes other than in accordance with generally accepted best industry practices. This includes, but is not limited to neglect, accident, alterations, surface markings, minor imperfections and normal wear.



To submit a non-equipment warranty claim, contact Winco at: cs@wincous.com



Winco, hereinafter referred to as "the Company," warrants its commercial parts to be free from defects in materials and workmanship under normal use for a period of 90 days from the date of purchase.

COVERAGE

This warranty covers parts used in equipment supplied by the company. During the warranty period, the company will, at its discretion, repair or replace any defective part or component.

EXCLUSIONS

THIS WARRANTY DOES NOT COVER:

1)	Damage resulting from improper installation, misuse, or neglect.
2)	Parts subjected to unauthorized modifications or repairs.
3)	Parts that experience natural aging, Blades, Lava Rocks, Fuses, Lamps & Gear Sets.
4)	Damage caused by accidents, natural disasters, or other external factors.

CLAIM PROCEDURE

Winco Warranty/Service Online Portal: www.wincous.com/contact-us/product-technical-support

To make a warranty claim, contact the company within the warranty period and provide proof of purchase. The company may request additional information to assess the claim. If a defect covered by this warranty is found, the Company will, at its option, repair or replace the defective part.

LIMITATION OF LIABILITY

The liability of the company under this warranty is limited to the repair or replacement of defective parts. The company shall not be liable for any incidental or consequential damages, including but not limited to loss of profits or business interruption.



~ Quality bar supplies for the complete bar experience ~



WINCO® | Foodservice Supplies

NEW JERSEY HEADQUARTERS

65 Industrial Road,
Lodi, NJ 07644

FLORIDA SHOWROOM & DISTRIBUTION CENTER

10800 NW 103rd Street,
Bldg 22, Ste 11, Miami, FL 33178

NEVADA DISTRIBUTION CENTER

3777 Marion Drive
Las Vegas, NV 89115

WINCO-NOP



Phone: 1-888-946-2682 | Fax: 1-973-916-9959 | Email: cs@wincous.com

2024 Catalog

05/2024

Check your order status online at www.wincous.com

